

[POWER COMMANDER V]

2005-2013 BMW R1200 R/RT

Installation Instructions



PARTS LIST

- 1 Power Commander
- 1 USB Cable
- 1 Installation Guide
- 2 Power Commander Decals
- 2 Dynojet Decals
- 2 Velcro strips
- 1 Alcohol swab

**THE IGNITION MUST BE TURNED
OFF BEFORE INSTALLATION!**

THE LATEST POWER COMMANDER
SOFTWARE AND MAP FILES CAN BE
DOWNLOADED FROM OUR WEB SITE AT:
www.powercommander.com

PLEASE READ ALL DIRECTIONS BEFORE STARTING INSTALLATION

Dynojet

2191 Mendenhall Drive North Las Vegas, NV 89081 (800) 992-4993 www.powercommander.com

POWER COMMANDER V INPUT ACCESSORY GUIDE

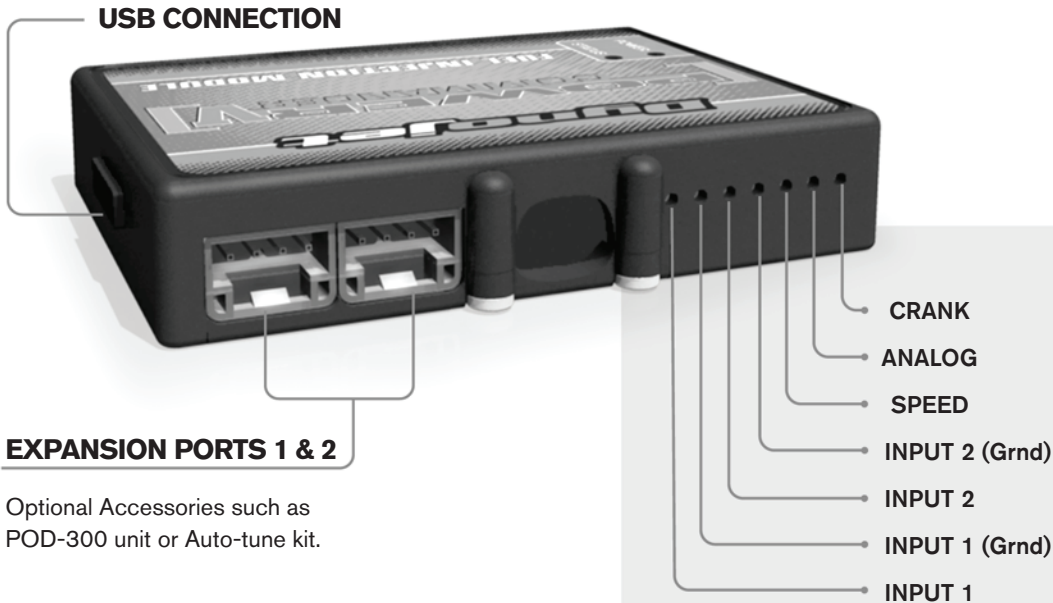

Wire connections:

To input wires into the PCV first remove the rubber plug on the backside of the unit and loosen the screw for the corresponding input. Using a 22-24 gauge wire strip about 10mm from its end. Push the wire into the hole of the PCV until it stops and then tighten the screw. Make sure to reinstall the rubber plug.

NOTE: If you tin the wires with solder it will make inserting them easier.

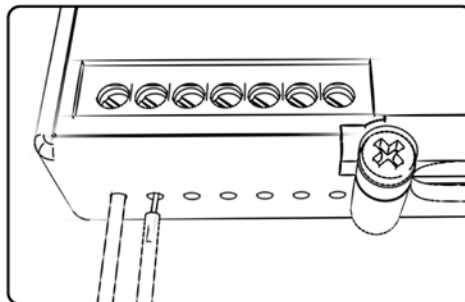

ACCESSORY INPUTS

Map -

(Input 1 or 2) The PCV has the ability to hold 2 different base maps. You can switch on the fly between these two base maps when you hook up a switch to the MAP inputs. You can use any open/close type switch. The polarity of the wires is not important. When using the Autotune kit one position will hold a base map and the other position will let you activate the learning mode. When the switch is "CLOSED" Autotune will be activated. (Set to Switch Input #1 by default.)

Shifter-

(Input 1 or 2) These inputs are for use with the Dynojet quickshifter. Insert the wires from the Dynojet quickshifter into the SHIFTER inputs. The polarity of the wires is not important. (Set to Switch Input #2 by default.)

Speed-

If your application has a speed sensor then you can tap into the signal side of the sensor and run a wire into this input. This will allow you to calculate gear position in the Control Center Software. Once gear position is setup you can alter your map based on gear position and setup gear dependent kill times when using a quickshifter.

Analog-

This input is for a 0-5v signal such as engine temp, boost, etc. Once this input is established you can alter your fuel curve based on this input in the control center software.

Crank-

Do **NOT** connect anything to this port unless instructed to do so by Dynojet. It is used to transfer crank trigger data from one module to another.

DO NOT TURN ON THE IGNITION WHILE ANY CONNECTIONS ARE UNPLUGGED.

- 1 Remove the main seat.
- 2 Lay the PCV under the seat area temporarily.
- 3 Unplug the stock wiring harness from the right side fuel injector (Fig. A).

- 4 Plug the pair of PCV leads with YELLOW colored wires in-line of the right side fuel injector and the stock wiring harness (Fig. B).

- 5 Unplug the stock wiring harness from the left side fuel injector.
- 6 Unplug the stock wiring harness from the Throttle Position Sensor (Fig. C).

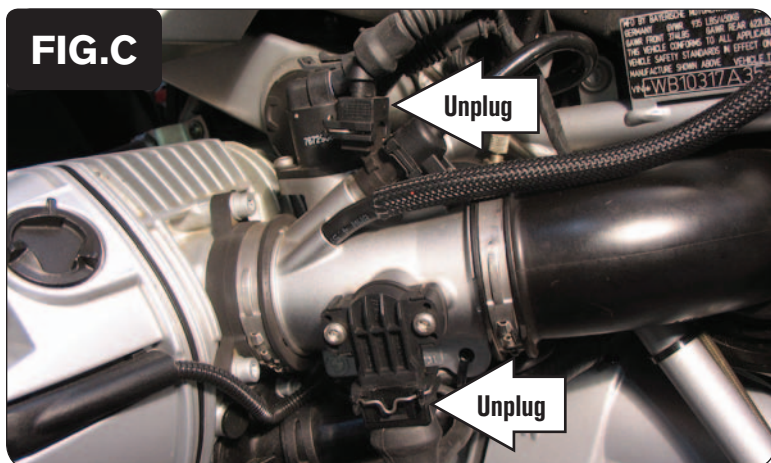
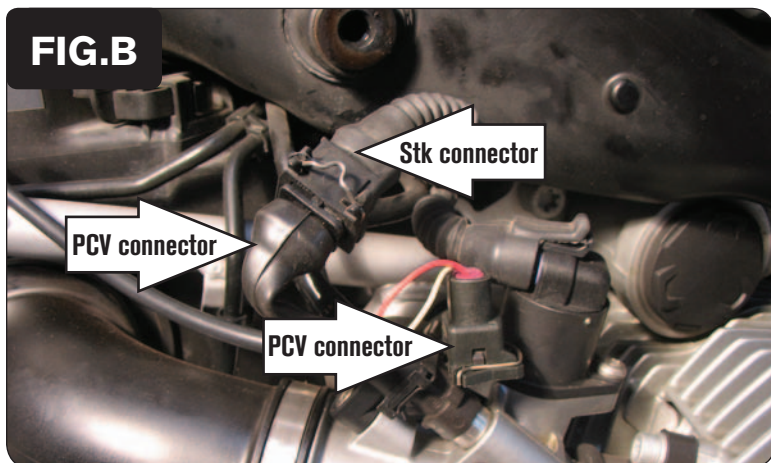
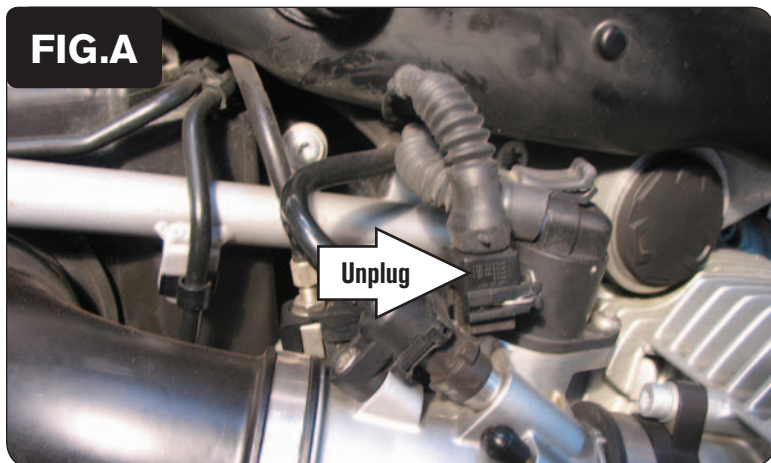

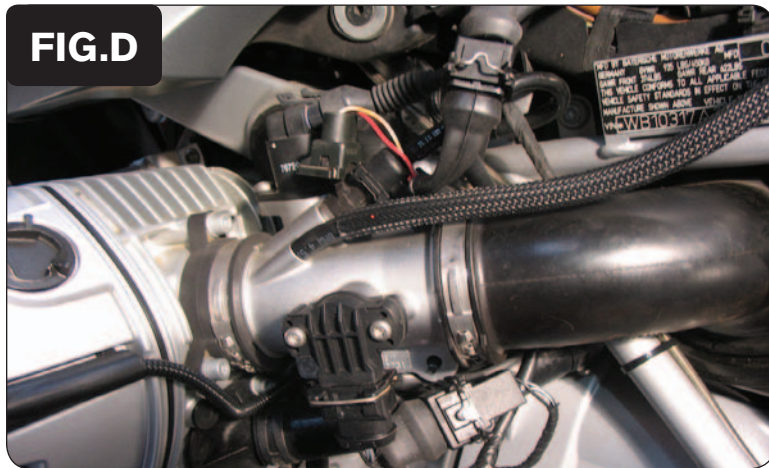

- 7 Route the PCV harness behind the intake tube.
- 8 Plug the pair of PCV leads with ORANGE colored wires in-line of the left fuel injector and the stock wiring harness.
- 9 Plug the pair of PCV leads with 3-pin connectors in-line of the bike's Throttle Position Sensor and the stock wiring harness (Fig. D).

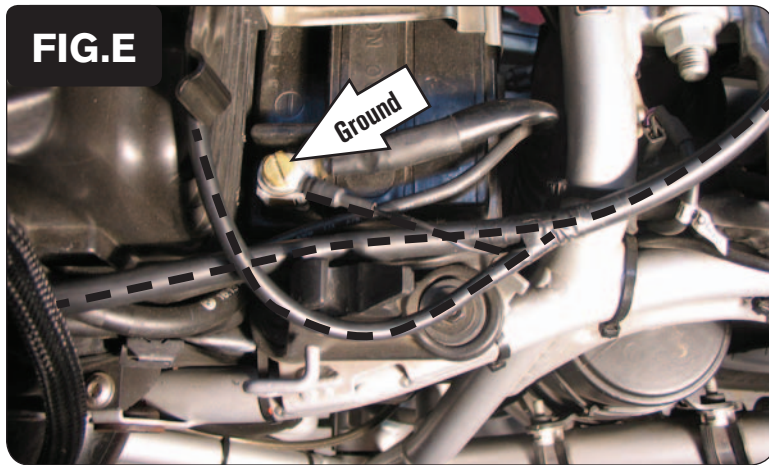

- 10 Attach the ground wire of the PCV with the small ring lug to the negative (-) terminal of the bike's battery (Fig. E).

****MAKE SURE THE GROUND WIRE IS SECURE.****

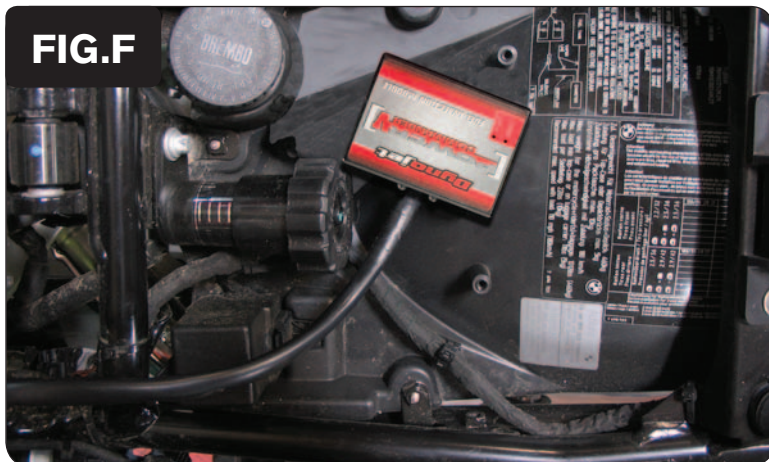

- 11 Install the PCV in the area under the main seat. You can use the supplied Velcro or zip ties to secure the unit depending on your setup (Fig. F).

Clean both surfaces with the supplied alcohol swab prior to applying the Velcro adhesive.

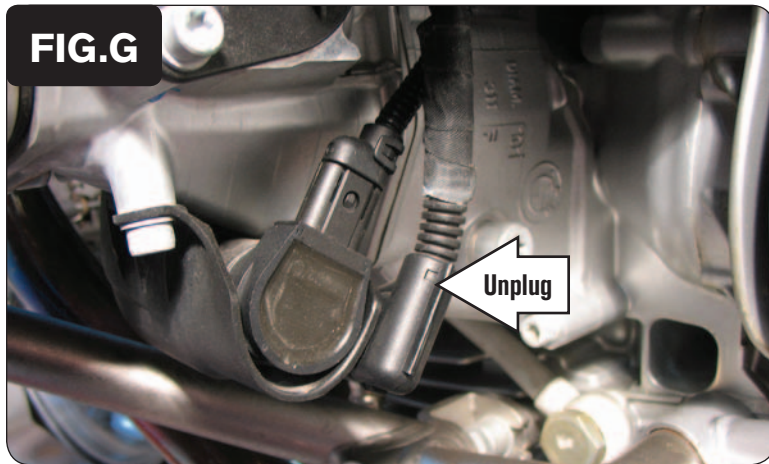

- 12 Unplug the stock O2 sensor from the main wiring harness on the left hand side (Fig. G).

This connector is located near the lower ignition coil.

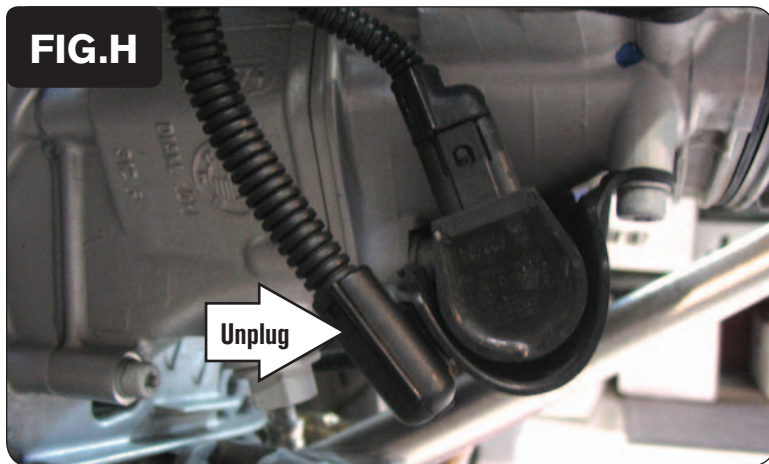

- 13 Unplug the stock O2 sensor from the main wiring harness on the right hand side (Fig. H).

This connector is located near the lower ignition coil.

The stock O2 sensors will no longer be connected to anything. They can be removed completely from the exhaust if desired and if you have a way to plug the holes in the exhaust.

- 14 Make sure all connections are secure and wiring harness routing is free and clear of any hot or moving parts. Reinstall the seat.