

[POWER COMMANDER V]

2007-2015 BMW F800 ST/GT/R

Installation Instructions



PARTS LIST

- 1 Power Commander
- 1 USB Cable
- 1 Installation Guide
- 2 Power Commander Decals
- 2 Dynojet Decals
- 2 Velcro strips
- 1 Alcohol swab

**THE IGNITION MUST BE TURNED
OFF BEFORE INSTALLATION!**

THE LATEST POWER COMMANDER
SOFTWARE AND MAP FILES CAN BE
DOWNLOADED FROM OUR WEB SITE AT:
www.powercommander.com

PLEASE READ ALL DIRECTIONS BEFORE STARTING INSTALLATION

Dynojet

2191 Mendenhall Drive North Las Vegas, NV 89081 (800) 992-4993 www.powercommander.com

POWER COMMANDER V INPUT ACCESSORY GUIDE

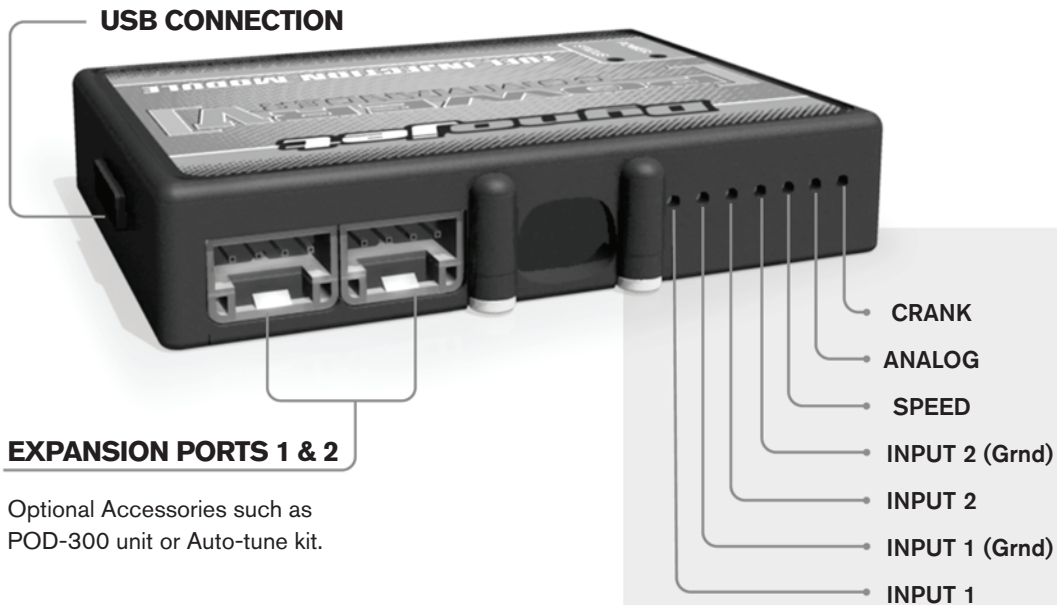

Wire connections:

To input wires into the PCV first remove the rubber plug on the backside of the unit and loosen the screw for the corresponding input. Using a 22-24 gauge wire strip about 10mm from its end. Push the wire into the hole of the PCV until it stops and then tighten the screw. Make sure to reinstall the rubber plug.

NOTE: If you tin the wires with solder it will make inserting them easier.

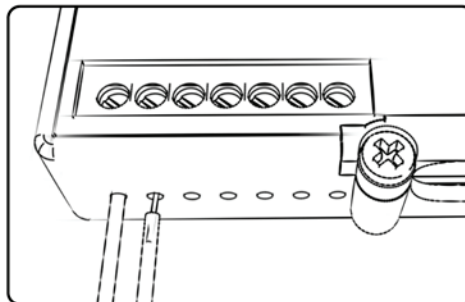

ACCESSORY INPUTS

Map -

(Input 1 or 2) The PCV has the ability to hold 2 different base maps. You can switch on the fly between these two base maps when you hook up a switch to the MAP inputs. You can use any open/close type switch. The polarity of the wires is not important. When using the Autotune kit one position will hold a base map and the other position will let you activate the learning mode. When the switch is "CLOSED" Autotune will be activated.

Shifter-

(Input 1 or 2) These inputs are for use with the Dynojet quickshifter. Insert the wires from the Dynojet quickshifter into the SHIFTER inputs. The polarity of the wires is not important.

Speed-

If your application has a speed sensor then you can tap into the signal side of the sensor and run a wire into this input. This will allow you to calculate gear position in the Control Center Software. Once gear position is setup you can alter your map based on gear position and setup gear dependent kill times when using a quickshifter.

Analog-

This input is for a 0-5v signal such as engine temp, boost, etc. Once this input is established you can alter your fuel curve based on this input in the control center software.

Crank-

Do **NOT** connect anything to this port unless instructed to do so by Dynojet. It is used to transfer crank trigger data from one module to another.

DO NOT TURN ON THE IGNITION WHILE ANY CONNECTIONS ARE UNPLUGGED.

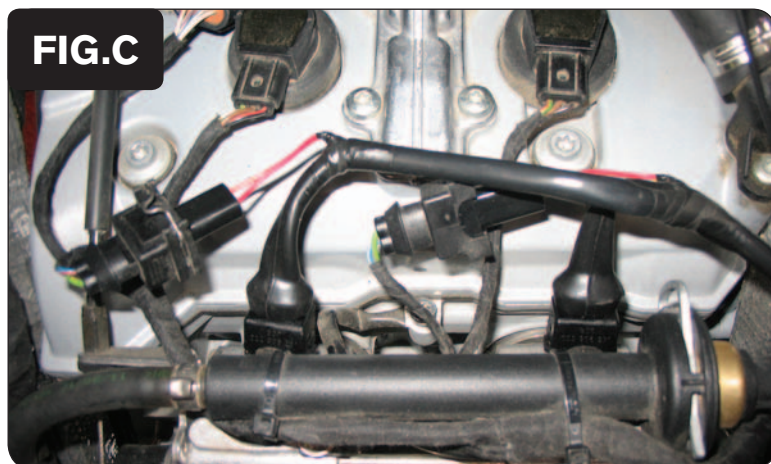
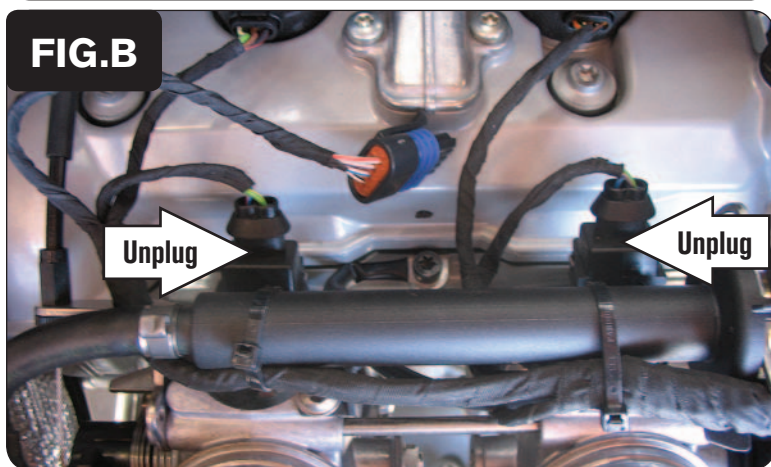
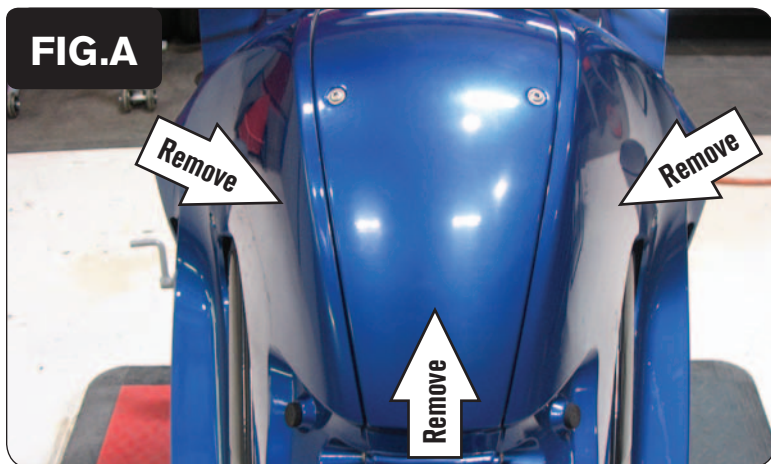

1 Remove the following:

- Seat
- Battery
- Upper side fairings
- Airbox
- Middle cover
- Lower Fairings

2 Unplug the stock wiring harness from both fuel injectors (Fig. B)

3 Lay the PCV near the fuel pump (under seat) temporarily.

4 Route the PCV harness along the right hand side of the bike and go towards the throttle bodies.

5 Plug the PCV harness in-line of the stock wiring harness and both fuel injectors (Fig. C).

The pair of PCV leads with ORANGE colored wires go in-line of the cylinder #1 (left) fuel injector.

The pair of PCV leads with YELLOW colored wires go in-line of the cylinder #2 (right) fuel injector.

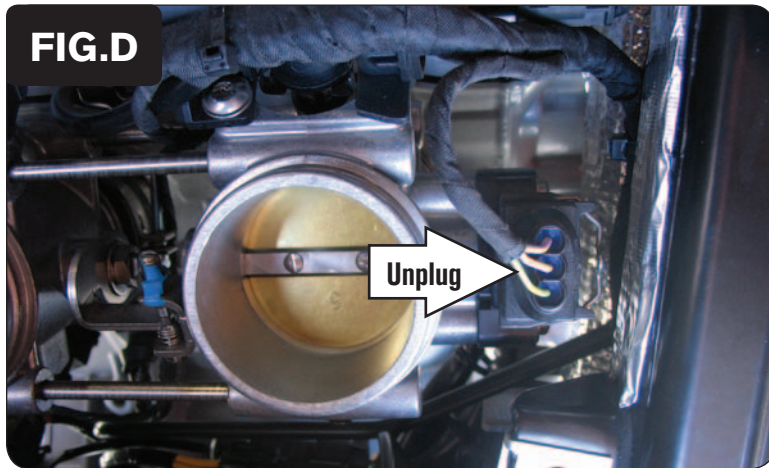

- 6 Unplug the stock wiring harness from the Throttle Position Sensor (Fig. D).
This connector is located on the right hand side of the throttle bodies.

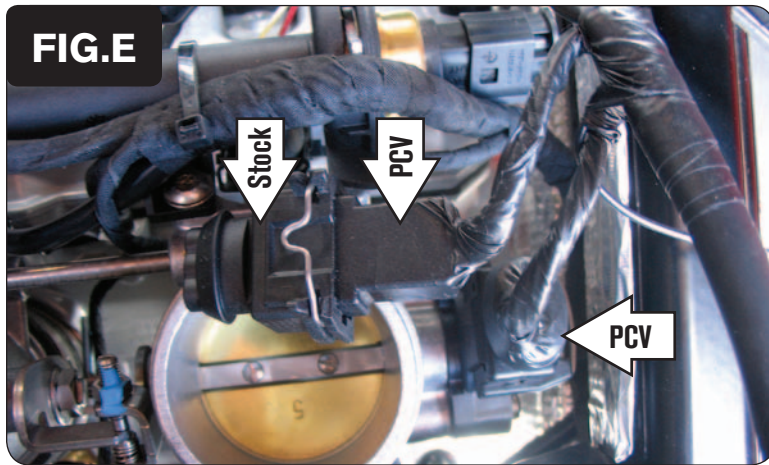

- 7 Plug the PCV harness in-line of the stock wiring harness and the Throttle Position Sensor (Fig. E).



- 8 Reinstall the airbox.
- 9 Reinstall the battery. Attach the ground wire of the PCV with the small ring lug to the negative (-) terminal of the bike's battery (Fig. F).

FIG.G

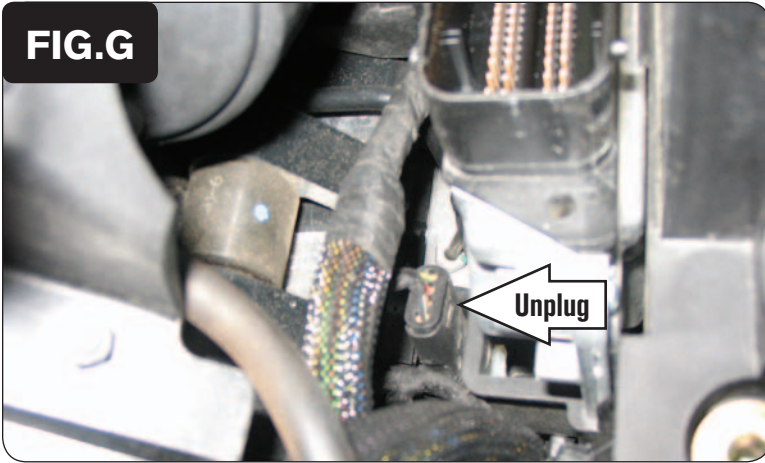

- 10 Disconnect the stock O2 sensor from the main wiring harness (Fig. G).

This connection is located behind the ECM. Unplugging the wiring harness from the ECM will make this easier.

The stock O2 sensor will no longer be connected. The sensor can be removed from the exhaust if desired and if you have a way to plug the hole in the exhaust.

FIG.H

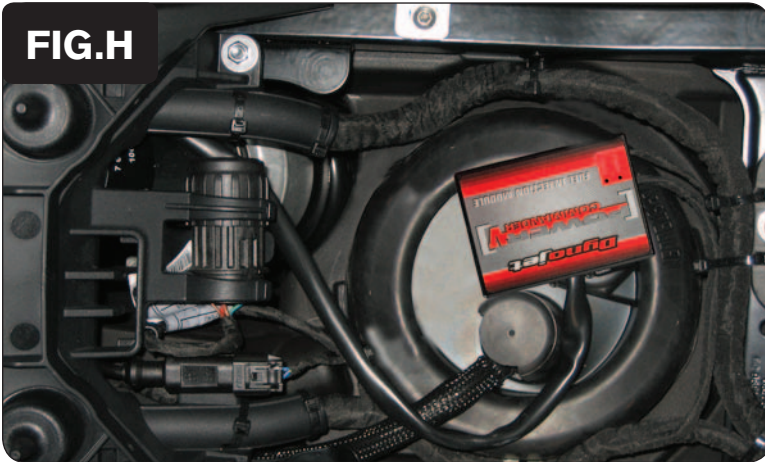

- 11 Install the PCV under the seat using the supplied Velcro

Make sure to clean both surfaces with the alcohol swab before attaching.

- 12 Reinstall all of the bodywork and the seat.

Make sure that all connections are secure before starting the motorcycle.

Note: This unit comes shipped with a stock map for an ST model. If this does not match your setup, you can download more maps from our website (www.powercommander.com).