

[POWER COMMANDER V]

2014 BMW R nineT

Installation Instructions



PARTS LIST

- 1 Power Commander
- 1 USB Cable
- 1 Installation Guide
- 2 Power Commander Decals
- 2 Dynojet Decals
- 2 Velcro strips
- 1 Alcohol swab

THE IGNITION MUST BE TURNED OFF BEFORE INSTALLATION!

THE LATEST POWER COMMANDER SOFTWARE AND MAP FILES CAN BE DOWNLOADED FROM OUR WEB SITE AT:
www.powercommander.com

PLEASE READ ALL DIRECTIONS BEFORE STARTING INSTALLATION

Dynojet

2191 Mendenhall Drive North Las Vegas, NV 89081 (800) 992-4993 www.powercommander.com

POWER COMMANDER V INPUT ACCESSORY GUIDE

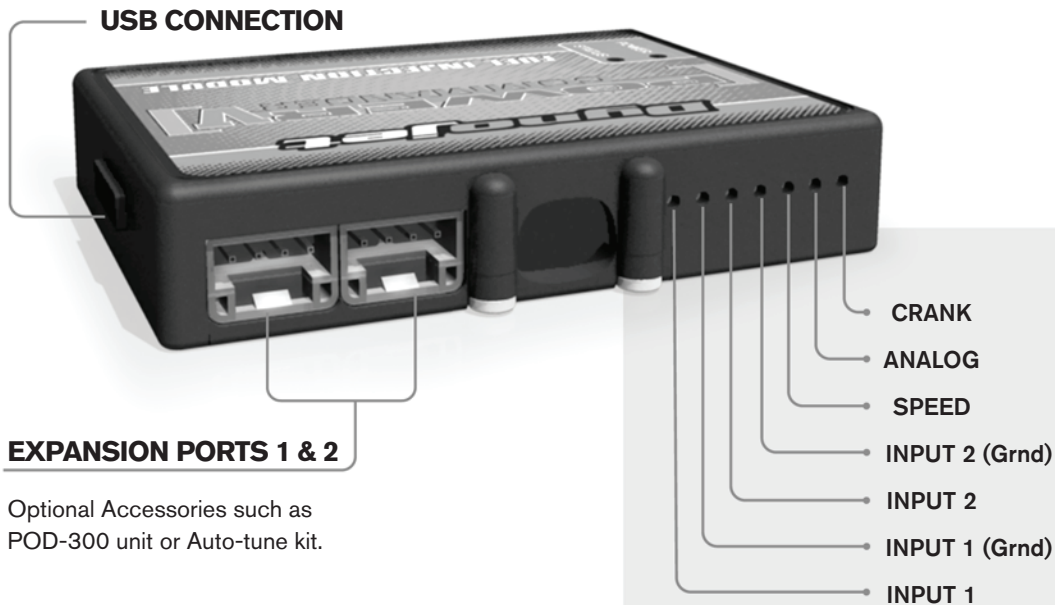

Optional Accessories such as
POD-300 unit or Auto-tune kit.

Wire connections:

To input wires into the PCV first remove the rubber plug on the backside of the unit and loosen the screw for the corresponding input. Using a 22-24 gauge wire strip about 10mm from its end. Push the wire into the hole of the PCV until it stops and then tighten the screw. Make sure to reinstall the rubber plug.

NOTE: If you tin the wires with solder it will make inserting them easier.

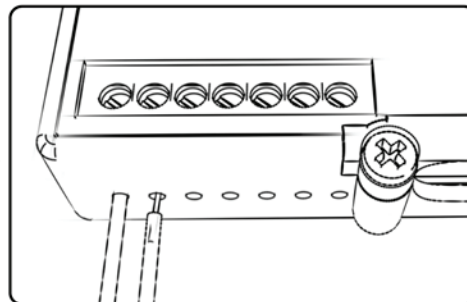

ACCESSORY INPUTS

Map -

(Input 1 or 2) The PCV has the ability to hold 2 different base maps. You can switch on the fly between these two base maps when you hook up a switch to the MAP inputs. You can use any open/close type switch. The polarity of the wires is not important. When using the Autotune kit one position will hold a base map and the other position will let you activate the learning mode. When the switch is "CLOSED" Autotune will be activated. (Set to Switch Input #1 by default.)

Shifter-

(Input 1 or 2) These inputs are for use with the Dynojet quickshifter. Insert the wires from the Dynojet quickshifter into the SHIFTER inputs. The polarity of the wires is not important. (Set to Switch Input #2 by default.)

Speed-

If your application has a speed sensor then you can tap into the signal side of the sensor and run a wire into this input. This will allow you to calculate gear position in the Control Center Software. Once gear position is setup you can alter your map based on gear position and setup gear dependent kill times when using a quickshifter.

Analog-

This input is for a 0-5v signal such as engine temp, boost, etc. Once this input is established you can alter your fuel curve based on this input in the control center software.

Crank-

Do **NOT** connect anything to this port unless instructed to do so by Dynojet. It is used to transfer crank trigger data from one module to another.

DO NOT TURN ON THE IGNITION WHILE ANY CONNECTIONS ARE UNPLUGGED.

- 1 Remove both seats. Remove the seat support brackets on the left and right side of the bike. Remove the body panels directly below the fuel tank on the left and right side of the bike (Fig. A).
- 2 Loosen the fuel tank at the front and rear. Prop the rear of the fuel tank at least a few inches.

The fuel tank can be completely removed, if you prefer; but this would not be critical for this installation.

- 3 Using the supplied Velcro, secure the PCV module to the right side air intake tube beneath the fuel tank (Fig. B).

Clean both surfaces with the supplied alcohol swab prior to applying the Velcro adhesive.

- 4 Secure the PCV ground wire with the small ring lug to the negative (-) terminal of the bike's battery.

****MAKE SURE THE GROUND WIRE IS SECURE.****

- 5 Route the PCV wiring harness branch with 4 connectors towards the left cylinder head (Fig. C).
- 6 Route the other branch with only 2 connectors towards the right cylinder head (see Fig. B).

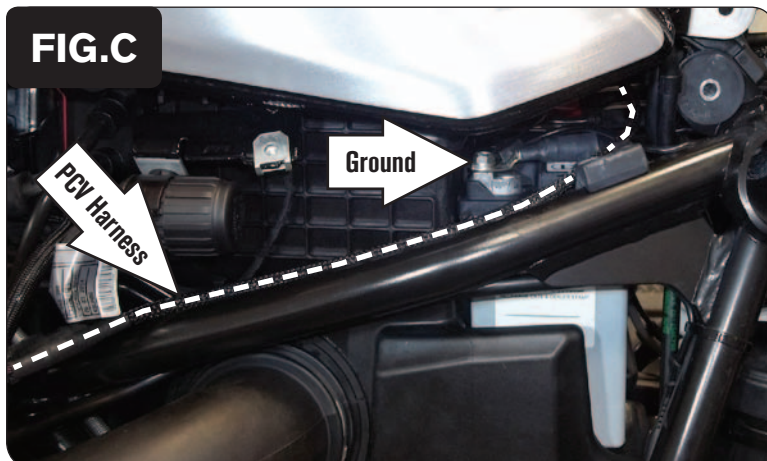
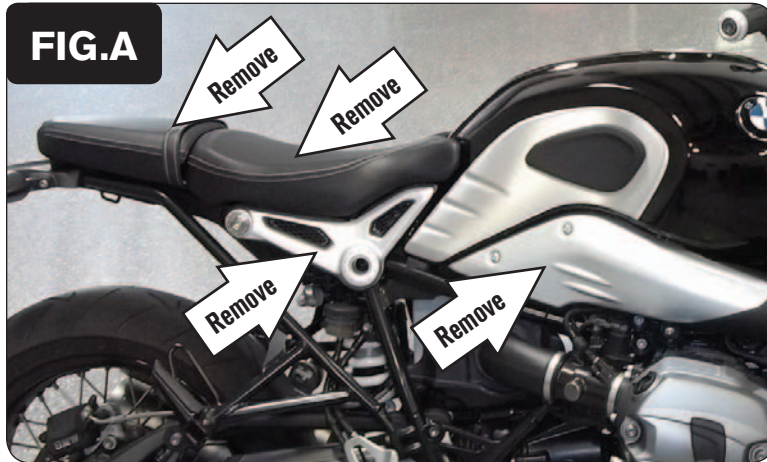

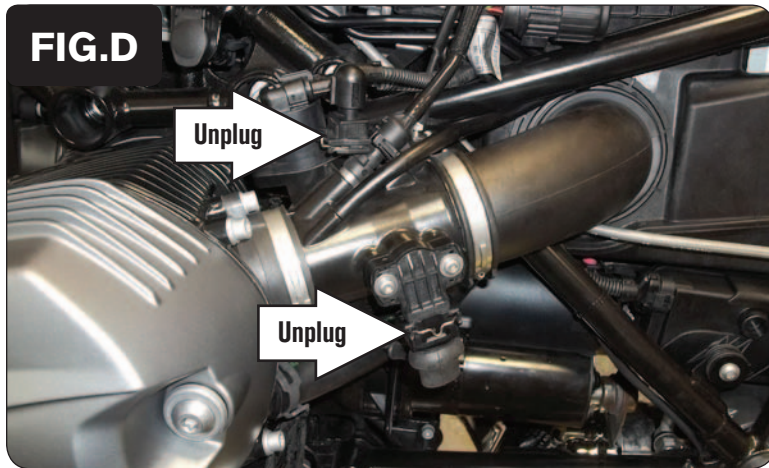

- 7 At the left side throttle body, unplug the fuel injector and unplug the Throttle Position Sensor (Fig. D).

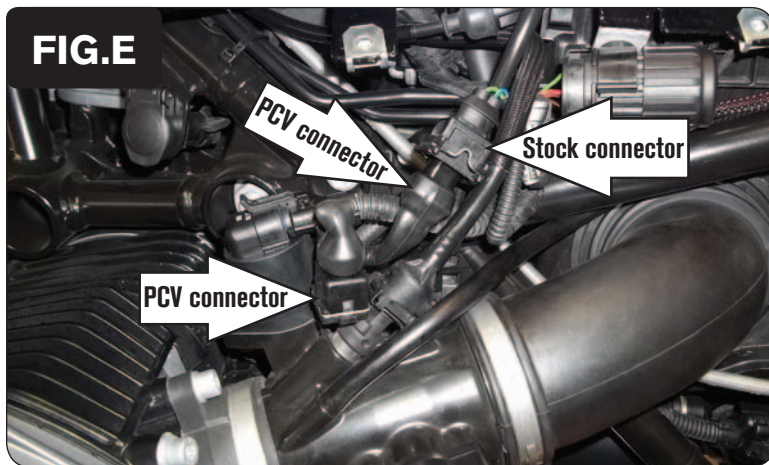

- 8 Plug the pair of PCV leads with ORANGE colored wires in-line of the left side fuel injector and the stock wiring harness (Fig. E).
- 9 Route the pair of 3-pin connectors behind the intake tube.

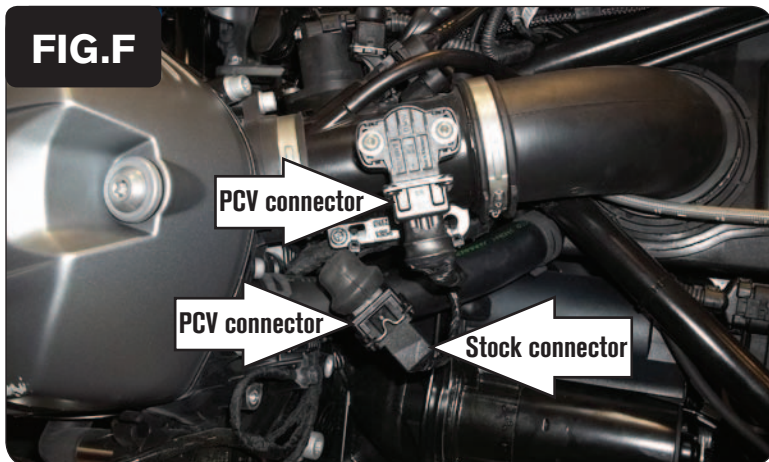

- 10 Plug the pair of 3-pin PCV leads in-line of the bike's Throttle Position Sensor and the stock wiring harness (Fig. F).

Tuck these extra connections discreetly behind and beneath the throttle body.

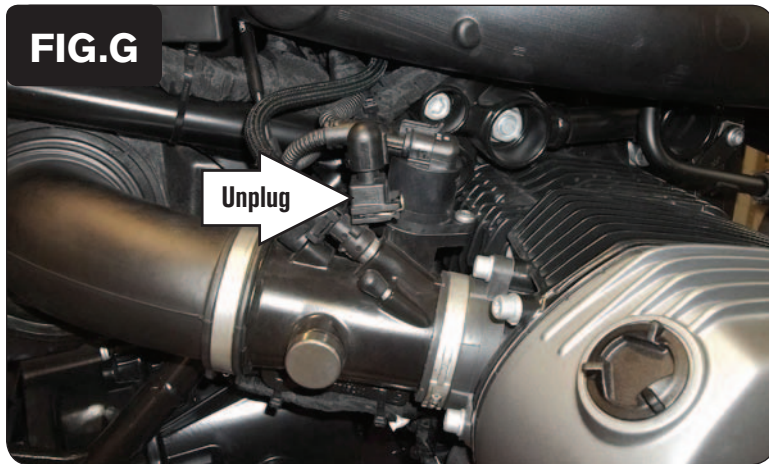

11 At the right side throttle body, unplug the Fuel Injector.

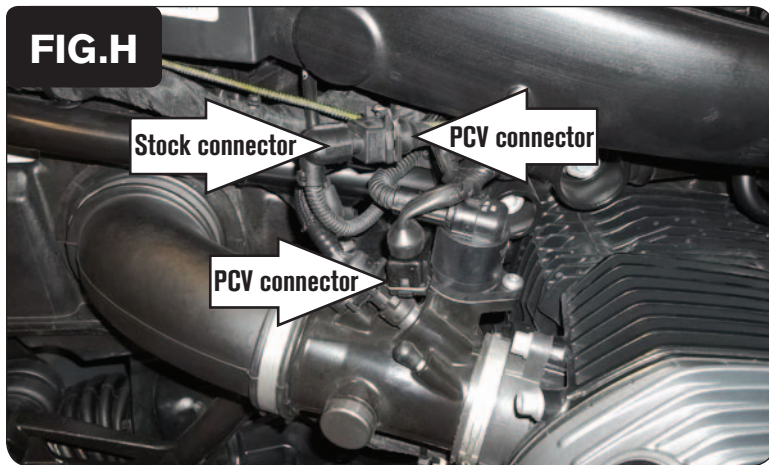

12 Plug the pair of PCV leads with YELLOW colored wires in-line of the right side Fuel Injector and the stock wiring harness.

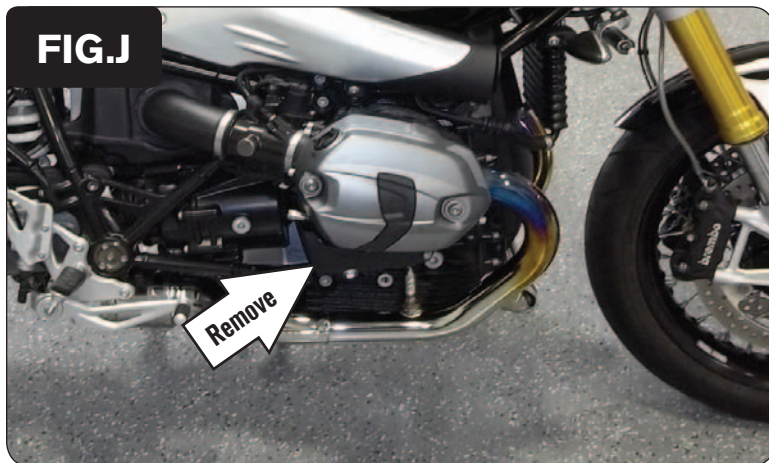

13 Remove the small plastic panels beneath the cylinder heads on both sides of the bike (Fig. J).

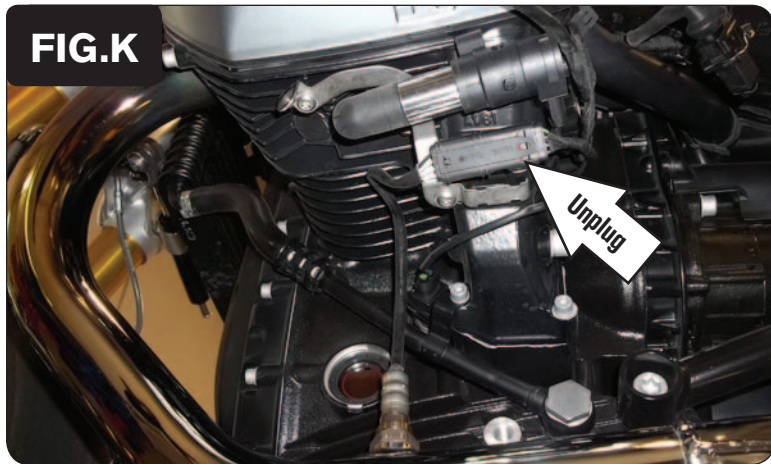

FIG.K

- 14 Unplug the stock O2 sensors beneath both cylinder heads on both sides of the bike (Fig. K).

The stock O2 sensors will no longer be used. They can be removed from the exhaust if desired and if you have a way to plug the holes in the exhaust (18mm x 1.5).

- 15 Make sure wiring harness routing is secured and clear of any hot or moving parts.
- 16 Reassemble the bike.