

[POWER COMMANDER V]

2011 Ducati M796

Installation Instructions



PARTS LIST

- 1 Power Commander
- 1 USB Cable
- 1 Installation Guide
- 2 Power Commander Decals
- 2 Dynojet Decals
- 4 Velcro strips
- 1 Alcohol swab
- 1 O2 Optimizer
- 1 Posi-tap

THE IGNITION MUST BE TURNED OFF BEFORE INSTALLATION!

THE LATEST POWER COMMANDER SOFTWARE AND MAP FILES CAN BE DOWNLOADED FROM OUR WEB SITE AT:
www.powercommander.com

PLEASE READ ALL DIRECTIONS BEFORE STARTING INSTALLATION

Dynojet

2191 Mendenhall Drive North Las Vegas, NV 89081 (800) 992-4993 www.powercommander.com

POWER COMMANDER V INPUT ACCESSORY GUIDE

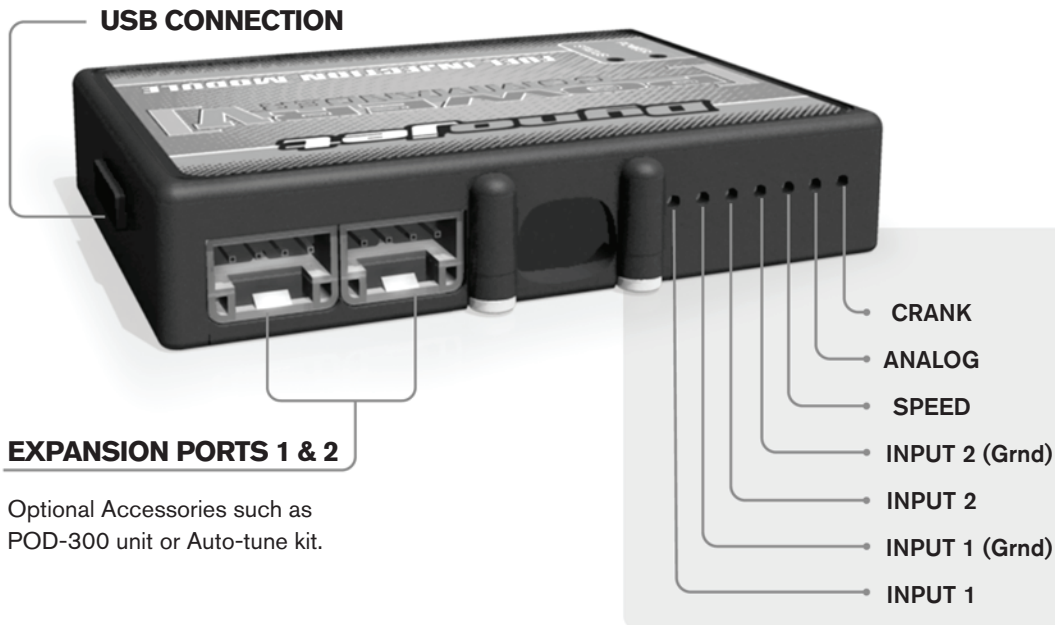

Optional Accessories such as
POD-300 unit or Auto-tune kit.

Wire connections:

To input wires into the PCV first remove the rubber plug on the backside of the unit and loosen the screw for the corresponding input. Using a 22-24 gauge wire strip about 10mm from its end. Push the wire into the hole of the PCV until it stops and then tighten the screw. Make sure to reinstall the rubber plug.

NOTE: If you tin the wires with solder it will make inserting them easier.

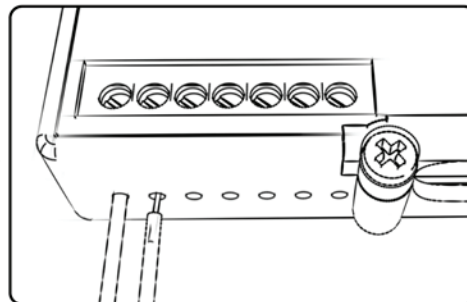

ACCESSORY INPUTS

Map -

(Input 1 or 2) The PCV has the ability to hold 2 different base maps. You can switch on the fly between these two base maps when you hook up a switch to the MAP inputs. You can use any open/close type switch. The polarity of the wires is not important. When using the Autotune kit one position will hold a base map and the other position will let you activate the learning mode. When the switch is "CLOSED" Autotune will be activated. (Set to Switch Input #1 by default.)

Shifter-

(Input 1 or 2) These inputs are for use with the Dynojet quickshifter. Insert the wires from the Dynojet quickshifter into the SHIFTER inputs. The polarity of the wires is not important. (Set to Switch Input #2 by default.)

Speed-

If your application has a speed sensor then you can tap into the signal side of the sensor and run a wire into this input. This will allow you to calculate gear position in the Control Center Software. Once gear position is setup you can alter your map based on gear position and setup gear dependent kill times when using a quickshifter.

Analog-

This input is for a 0-5v signal such as engine temp, boost, etc. Once this input is established you can alter your fuel curve based on this input in the control center software.

Crank-

Do **NOT** connect anything to this port unless instructed to do so by Dynojet. It is used to transfer crank trigger data from one module to another.

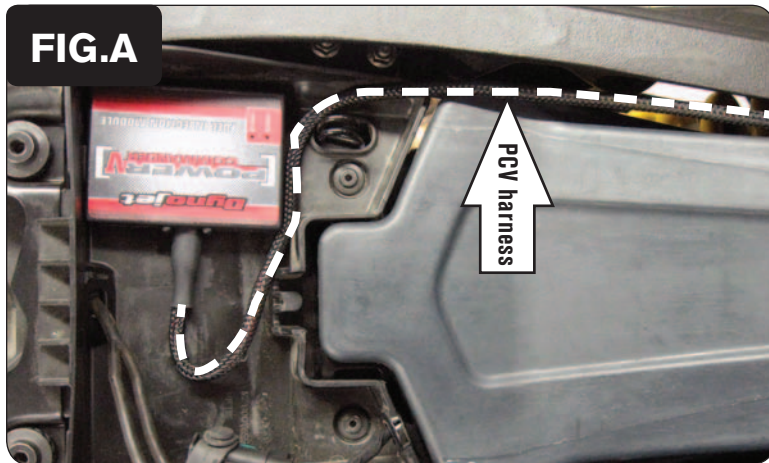

- 1 Remove the seat. Remove the tool kit.
- 2 Store the PCV module in the tail section and route the PCV wiring harness down the left side of the bike (Fig. A).

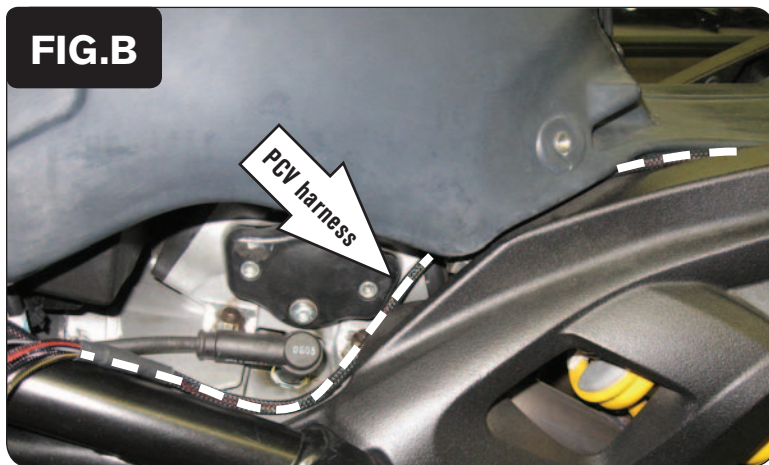

- 3 Continue routing the PCV harness along left hand side of the frame (Fig. B).

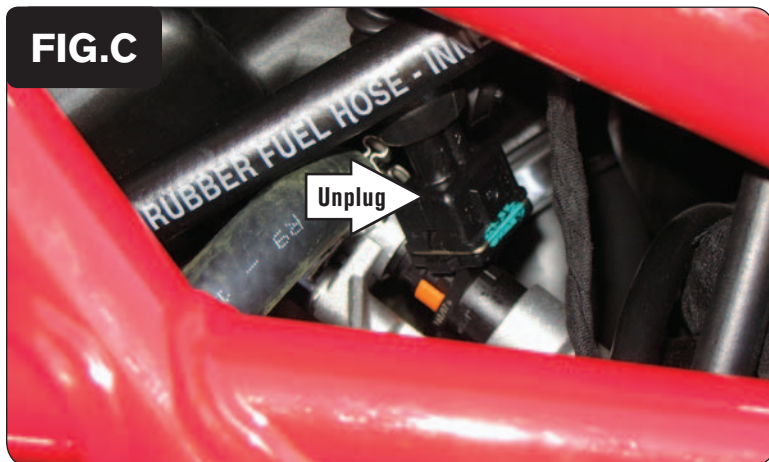

- 4 Unplug the stock wiring harness from the rear fuel injector (Fig. C).
This injector is located on the left hand side of the bike.

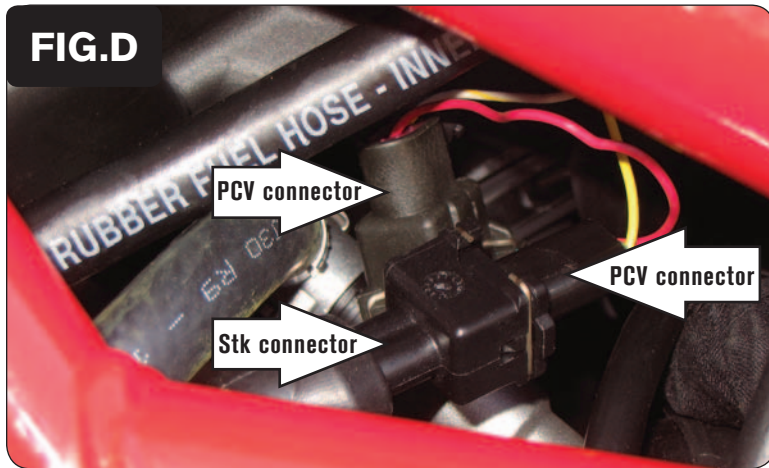

- 5 Plug the pair of PCV leads with YELLOW colored wires in-line of the rear fuel injector and the stock wiring harness (Fig. D).

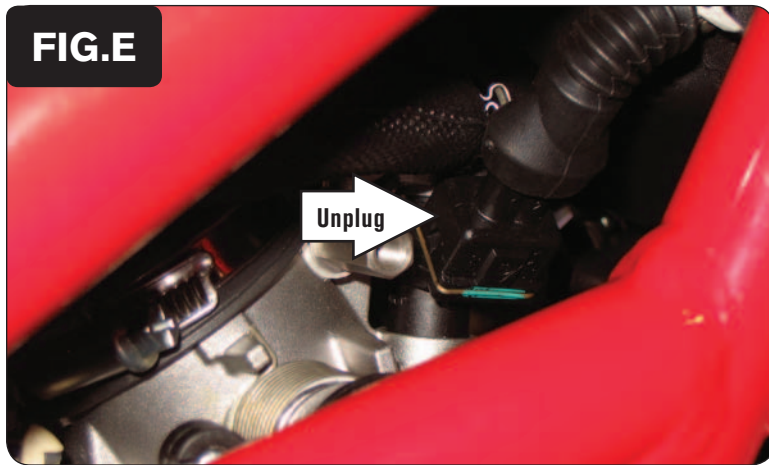

- 6 Unplug the stock wiring harness from the front fuel injector (Fig. E).
This injector is located on the right hand side of the bike.



- 7 Plug the pair of PCV leads with ORANGE colored wires in-line of the front fuel injector and the stock wiring harness (Fig. F).

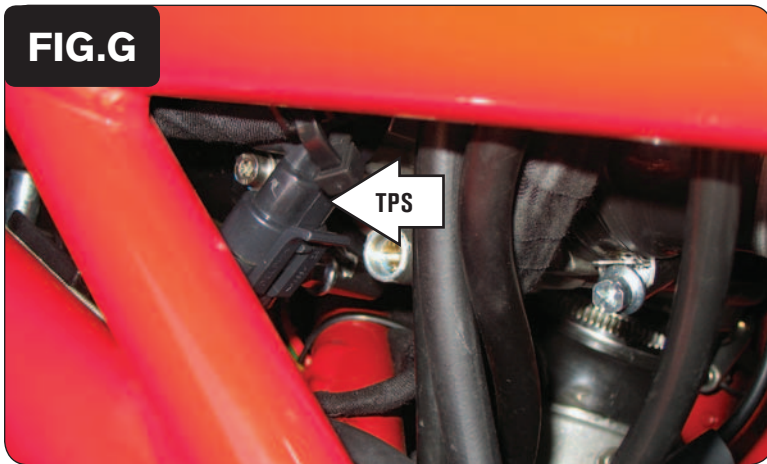

- 8 Locate and unplug the stock Throttle Position Sensor.

This sensor is located on the left side of the throttle bodies.

Unplugging the stock wiring harness from the sensor will allow access to its wires.



- 9 Using the supplied Posi-tap, attach the GREY wire of the PCV to the OR wire (C) of the TPS connector (Fig. H).

- 10 Plug the stock connector back on to the bike's TPS.

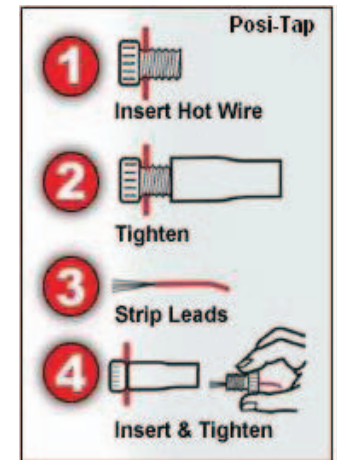

- 11 Remove the BLACK plastic engine cover on the left side of the bike by removing the 3 bolts (Fig. I).

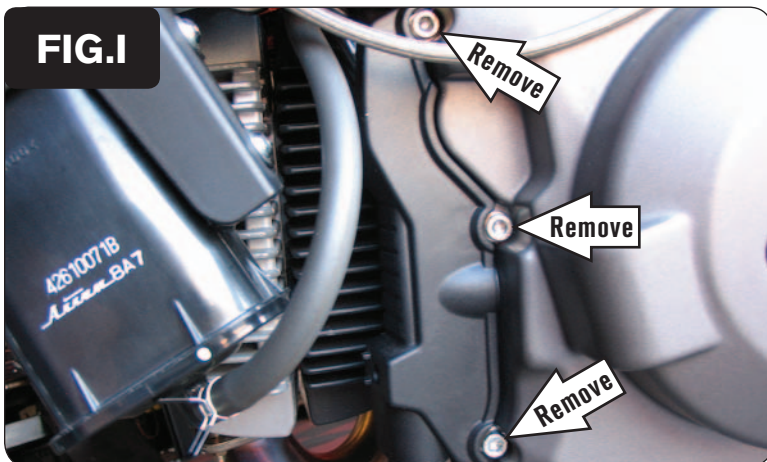

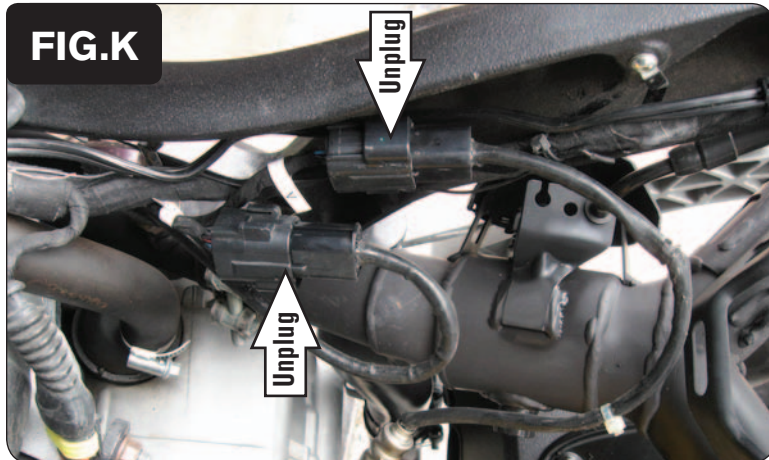
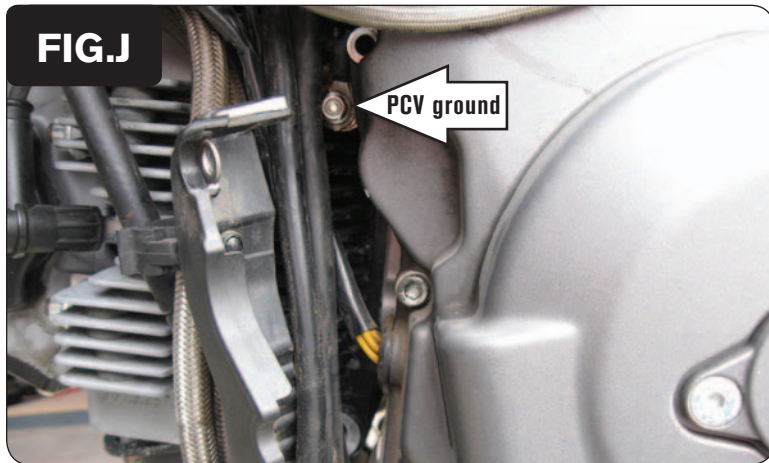

- 12 Attach the ground wire of the PCV to the stock ground location (Fig. J).
- 13 Reinstall the plastic cover.

- 14 Lift the rear of the fuel tank up.
- 15 Unplug both of the stock O2 sensors from the stock wiring harness (Fig. K).

Figure K is shown with the fuel tank removed but these steps can be done without removing the tank.

- 16 Plug the O2 Optimizer connectors labeled "Front" in-line of the front cylinder O2 sensor and stock wiring harness (marked with a O).
- 17 Plug the O2 Optimizer connectors labeled "Rear" in-line of the rear cylinder O2 sensor and stock wiring harness (marked with an V).

The O2 Optimizer connectors are labeled "FRONT" and "REAR" on the white sticker. Do NOT mix these up.

- 18 Tuck the connectors in the recessed openings of the RH frame.
- 19 Lower the fuel tank back into position making sure it does not interfere with any of the wiring harnesses.

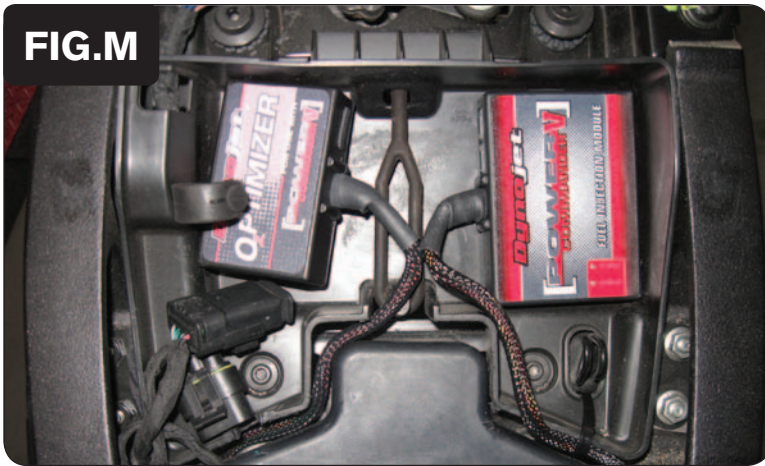

- 20 Using the supplied Velcro, secure both the PCV module and the O2 Optimizer module in the tail section.

Clean all surfaces with the supplied alcohol swab prior to applying the Velcro.

- 21 Reassemble the bike.

	0	2	5	10	15	20	40	60	80	100
500	0	0	0	0	0	0	0	0	0	0
750	0	0	0	0	0	0	0	0	0	0
1000	0	0	0	0	0	0	0	0	0	0
1250	0	0	0	0	0	0	0	0	0	0
1500	0	0	0	0	0	0	0	0	0	0
1750	0	0	0	0	0	0	0	0	0	0
2000	0	0	0	0	0	0	0	0	0	0
2250	0	0	0	0	0	0	0	0	0	0
2500	0	0	0	0	0	0	0	0	0	0
2750	0	0	0	0	0	0	0	0	0	0
3000	0	0	0	0	0	0	0	0	0	0
3250	0	0	0	0	0	0	0	0	0	0
3500	0	0	0	0	0	0	0	0	0	0
3750	0	0	0	0	0	0	0	0	0	0
4000	0	0	0	0	0	0	0	0	0	0
4250	0	0	0	0	0	0	0	0	0	0
4500	0	0	0	0	0	0	0	0	0	0
4750	0	0	0	0	0	0	0	0	0	0
5000	0	0	0	0	0	0	0	0	0	0
5250	0	0	0	0	0	0	0	0	0	0
5500	0	0	0	0	0	0	0	0	0	0
5750	0	0	0	0	0	0	0	0	0	0
6000	0	0	0	0	0	0	0	0	0	0
6250	0	0	0	0	0	0	0	0	0	0

Tuning Notes:

The O2 Optimizer for this model controls the stock closed loop range. This range is represented by the highlighted cells shown in Figure N. The O2 Optimizer is designed to achieve a target AFR of 13.6:1 in this range. To use this O2 Optimizer you must retain your stock O2 sensors (even if using the Auto-tune accessory).

It is important to have a blanket fuel change value of 10 across the entire closed loop range of the fuel table/tables of your map.

If using the Auto-tune accessory do NOT input values in this range of your Target AFR table/tables.