

[POWER COMMANDER V]

2008-2010 Ducati 848

Installation Instructions



PARTS LIST

- 1 Power Commander
- 1 USB Cable
- 1 Installation Guide
- 2 Power Commander Decals
- 2 Dynojet Decals
- 2 Velcro strips
- 1 Alcohol swab
- 3 Zip ties
- 1 Posi-tap

**THE IGNITION MUST BE TURNED
OFF BEFORE INSTALLATION!**

THE LATEST POWER COMMANDER
SOFTWARE AND MAP FILES CAN BE
DOWNLOADED FROM OUR WEB SITE AT:
www.powercommander.com

PLEASE READ ALL DIRECTIONS BEFORE STARTING INSTALLATION

Dynojet

2191 Mendenhall Drive North Las Vegas, NV 89081 (800) 992-4993 www.powercommander.com

POWER COMMANDER V INPUT ACCESSORY GUIDE

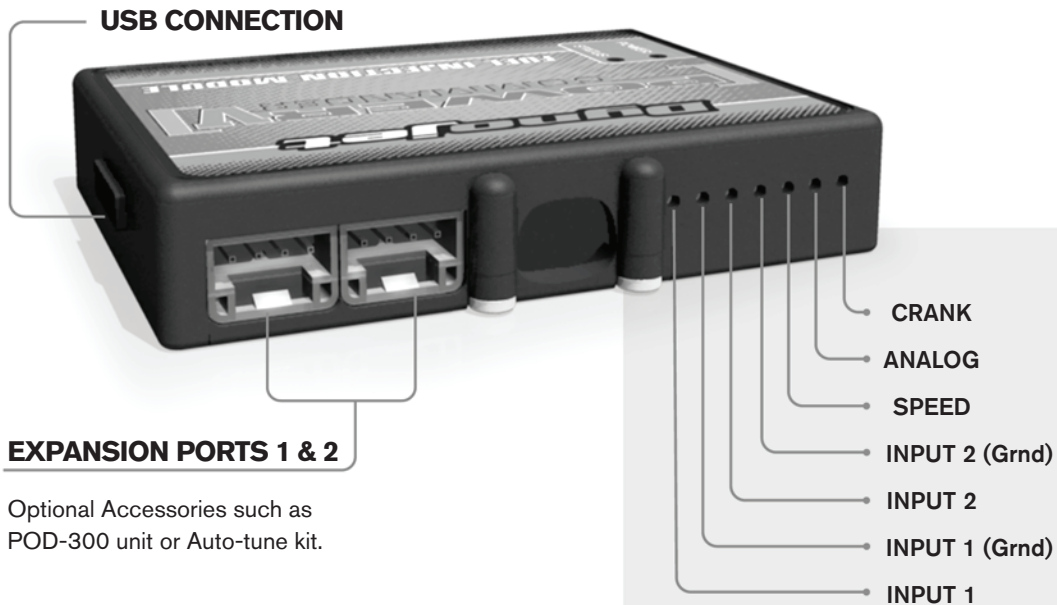

Wire connections:

To input wires into the PCV first remove the rubber plug on the backside of the unit and loosen the screw for the corresponding input. Using a 22-24 gauge wire strip about 10mm from its end. Push the wire into the hole of the PCV until it stops and then tighten the screw. Make sure to reinstall the rubber plug.

NOTE: If you tin the wires with solder it will make inserting them easier.

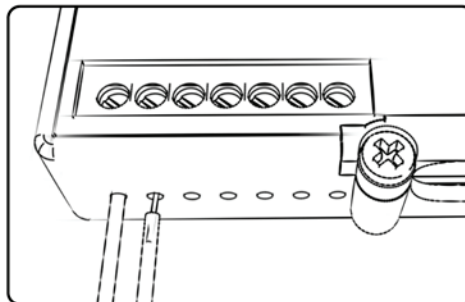

ACCESSORY INPUTS

Map -

(Input 1 or 2) The PCV has the ability to hold 2 different base maps. You can switch on the fly between these two base maps when you hook up a switch to the MAP inputs. You can use any open/close type switch. The polarity of the wires is not important. When using the Autotune kit one position will hold a base map and the other position will let you activate the learning mode. When the switch is "CLOSED" Autotune will be activated. (Set to Switch Input #1 by default.)

Shifter-

(Input 1 or 2) These inputs are for use with the Dynojet quickshifter. Insert the wires from the Dynojet quickshifter into the SHIFTER inputs. The polarity of the wires is not important. (Set to Switch Input #2 by default.)

Speed-

If your application has a speed sensor then you can tap into the signal side of the sensor and run a wire into this input. This will allow you to calculate gear position in the Control Center Software. Once gear position is setup you can alter your map based on gear position and setup gear dependent kill times when using a quickshifter.

Analog-

This input is for a 0-5v signal such as engine temp, boost, etc. Once this input is established you can alter your fuel curve based on this input in the control center software.

Crank-

Do **NOT** connect anything to this port unless instructed to do so by Dynojet. It is used to transfer crank trigger data from one module to another.

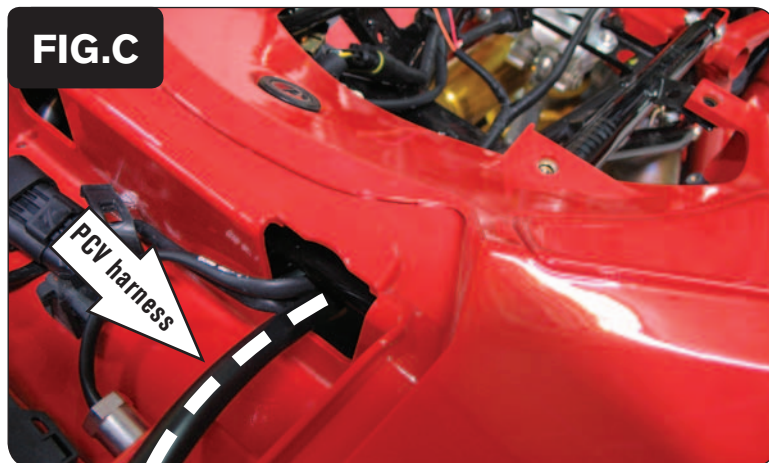

- 1 Remove the seat and solo cover.
- 2 Remove the cover around the fuel tank (Fig. A).
- 3 Remove the fuel tank.
- 4 Remove the inner fairing cover on the right hand side (Fig. B).
- 5 Lay the PCV in the tail section temporarily.
- 6 Route the PCV harness through the hole in the tail section (Fig. C).

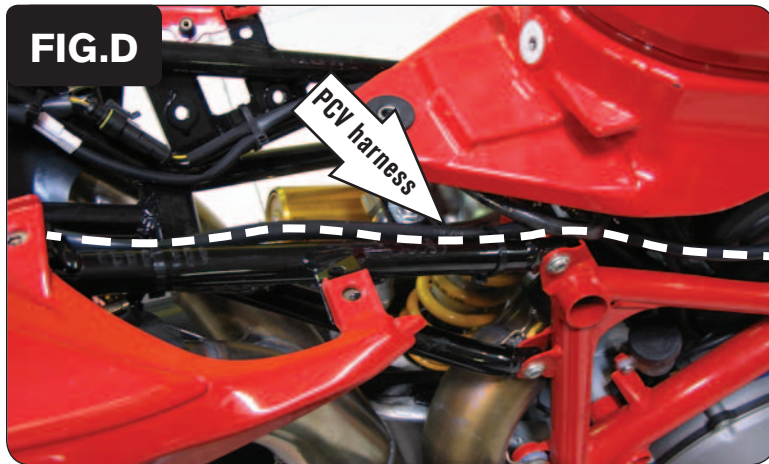

- 7 Route the PCV along the right hand side of the subframe. Secure the PCV harness to the subframe using the 2 large supplied zip-ties (Fig. D)

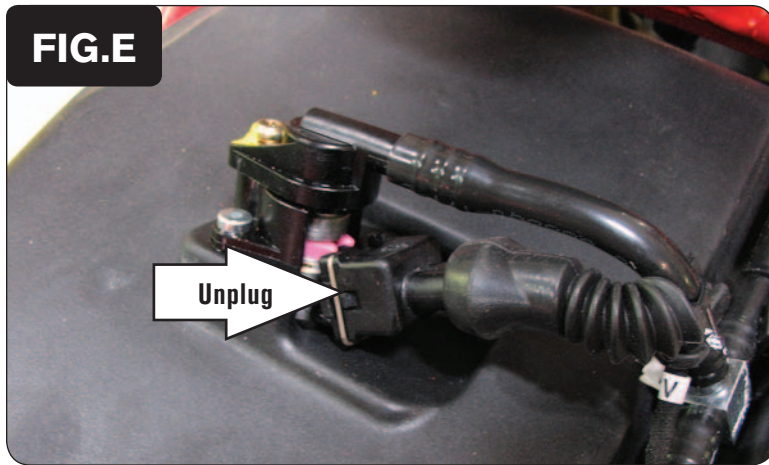

- 8 Unplug the stock wiring harness from the rear fuel injector (Fig. E).

This injector is located on top of the air box.

To remove the connector you must first remove the spring clip. This is best done with a pick or small screwdriver.

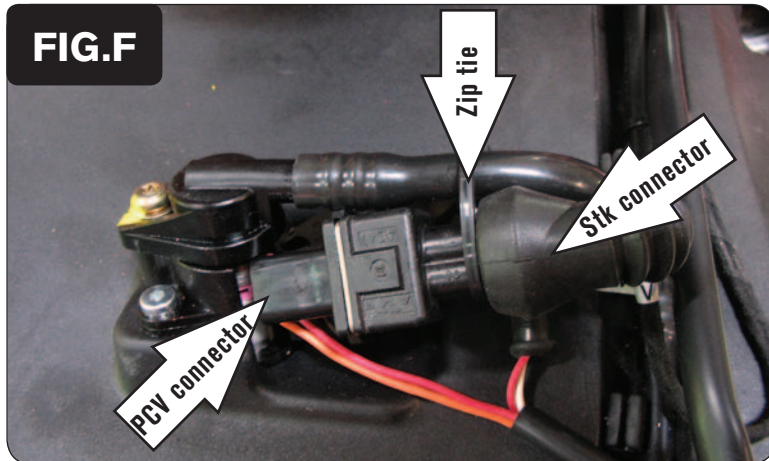

- 9 Plug the pair of PCV leads with YELLOW colored wires in-line of the stock wiring harness and the rear fuel injector (Fig. F).

Make sure to reinstall the spring clip on the stock connector.

- 10 Use the small supplied zip-tie to secure this connection to the fuel line.

Make this connection as compact as possible.

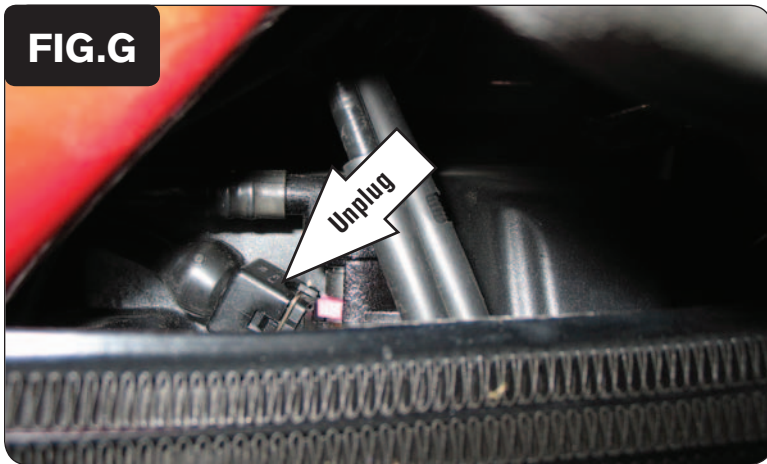

- 11 Unplug the stock wiring harness from the front fuel injector (Fig G).

This connection is very difficult to access. It is best to get to thru the front of the bike directly above the radiator. Figure G was taken from the front of the bike inside the right hand fairing and above the radiator.

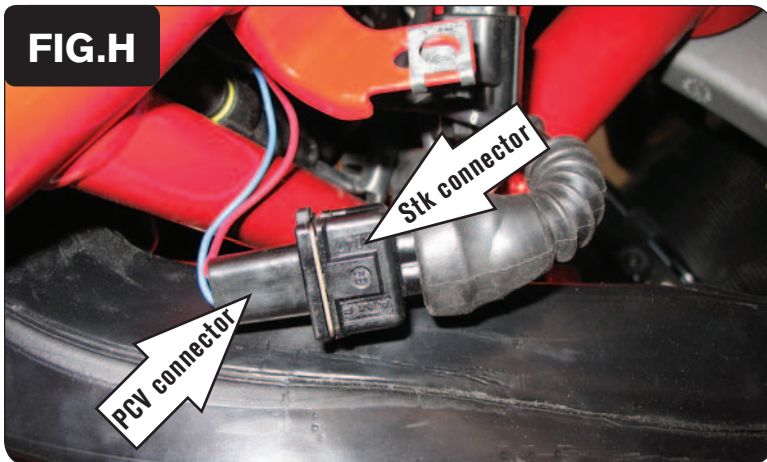

- 12 Plug the pair of PCV leads with ORANGE colored wires in-line of the front fuel injector and the stock wiring harness (Fig. H).
- 13 Remove the right hand fairing.

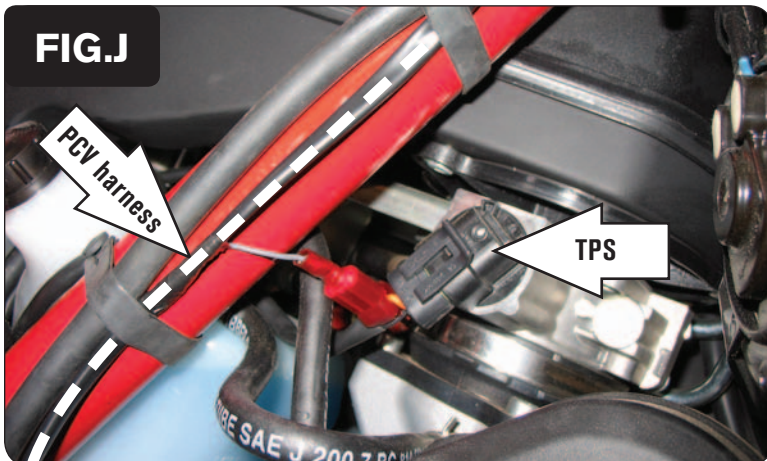

- 14 Route the PCV harness along the right hand side frame down tube. Use the existing wraps to hold the PCV harness in place (Fig. J).
- 15 Locate the Throttle Position Sensor on the right hand side of the throttle bodies.
- 16 Using the supplied posi-tap, attach the PCV GREY wire to the stock ORANGE wire of the bike's TPS (pin position C).

The wire tap shown in Figure J is NOT a Posi-tap. It is an older crimp-on style wire tap.

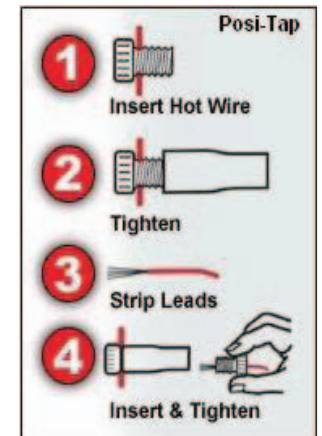

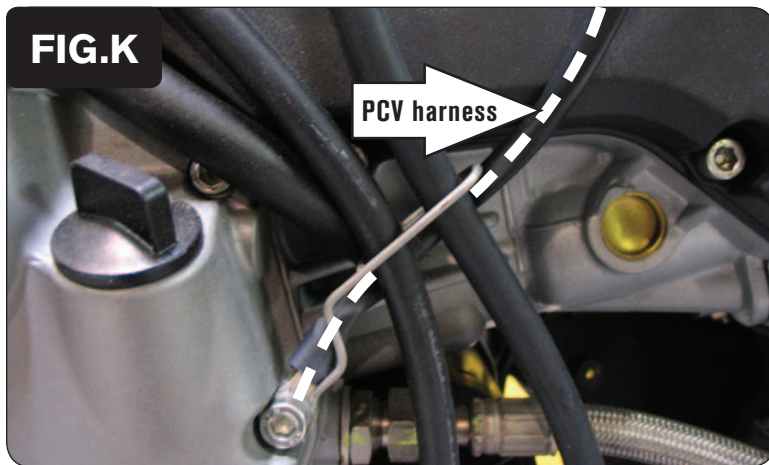

- 17 Attach the ground wire from the PCV with the small ring lug to the right hand engine cover bolt shown in Figure K.
- 18 Reinstall the right hand fairing.

- 19 Install the PCV in the tail section using the supplied Velcro.
Make sure to clean both surfaces with the alcohol swab before attaching.
- 20 Reinstall the fuel tank, bodywork, and seat. When lowering the fuel tank make sure it does not interfere with the connection of the rear injector.

Note: Unless you have the optional Dynojet O2 Optimizer (PN: 76125015) you will not be able to make fuel changes below 20% throttle and below 5500 RPM with this PCV.

Optional inputs:

Speed input - GREY/WHITE wire of 3-pin connector (GREY/WHITE - BLUE/ORANGE - GREEN)

Temperature input - WHITE/BLUE wire - behind battery on front cylinder

12v source for Auto-tune - YELLOW wire of tail light connector - 5-pin connector under the seat