

[POWER COMMANDER V]

2012-2013 Ducati 1199 Panigale

Installation Instructions



PARTS LIST

- 1 Power Commander
- 1 USB Cable
- 1 Installation Guide
- 2 Power Commander Decals
- 2 Dynojet Decals
- 2 Velcro strips
- 1 Alcohol swab

THE IGNITION MUST BE TURNED OFF BEFORE INSTALLATION!

THE LATEST POWER COMMANDER SOFTWARE AND MAP FILES CAN BE DOWNLOADED FROM OUR WEB SITE AT:
www.powercommander.com

PLEASE READ ALL DIRECTIONS BEFORE STARTING INSTALLATION

Dynojet

2191 Mendenhall Drive North Las Vegas, NV 89081 (800) 992-4993 www.powercommander.com

POWER COMMANDER V INPUT ACCESSORY GUIDE

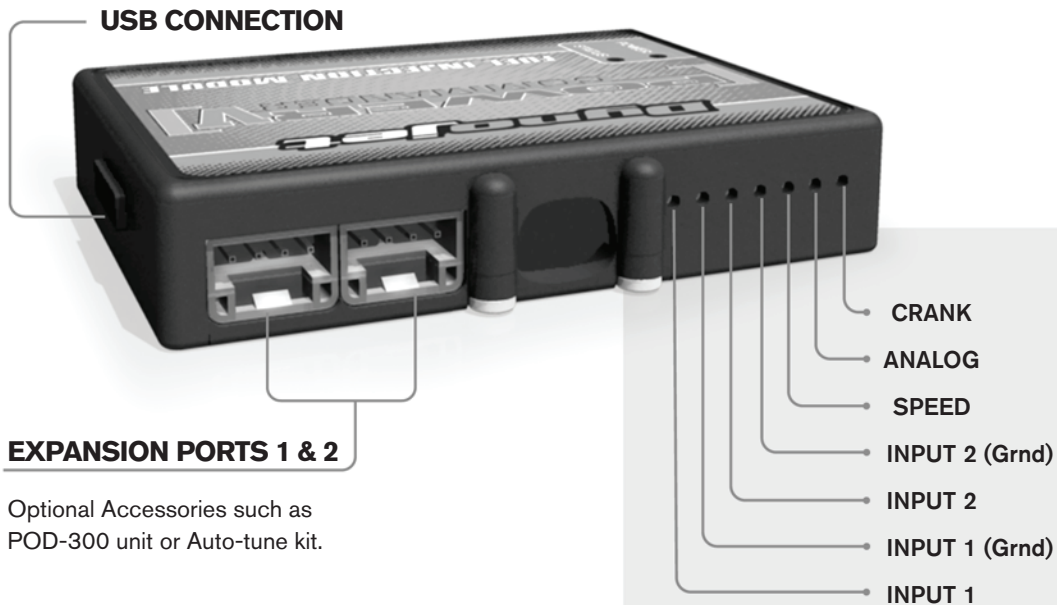

Optional Accessories such as
POD-300 unit or Auto-tune kit.

Wire connections:

To input wires into the PCV first remove the rubber plug on the backside of the unit and loosen the screw for the corresponding input. Using a 22-24 gauge wire strip about 10mm from its end. Push the wire into the hole of the PCV until it stops and then tighten the screw. Make sure to reinstall the rubber plug.

NOTE: If you tin the wires with solder it will make inserting them easier.

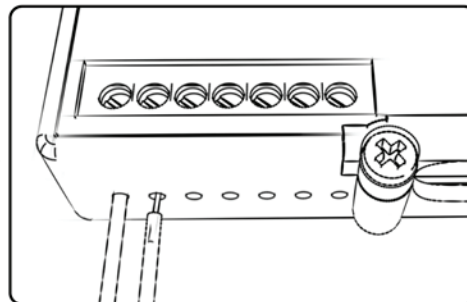

ACCESSORY INPUTS

Map -

(Input 1 or 2) The PCV has the ability to hold 2 different base maps. You can switch on the fly between these two base maps when you hook up a switch to the MAP inputs. You can use any open/close type switch. The polarity of the wires is not important. When using the Autotune kit one position will hold a base map and the other position will let you activate the learning mode. When the switch is "CLOSED" Autotune will be activated. (Set to Switch Input #1 by default.)

Shifter-

(Input 1 or 2) These inputs are for use with the Dynojet quickshifter. Insert the wires from the Dynojet quickshifter into the SHIFTER inputs. The polarity of the wires is not important. (Set to Switch Input #2 by default.)

Speed-

If your application has a speed sensor then you can tap into the signal side of the sensor and run a wire into this input. This will allow you to calculate gear position in the Control Center Software. Once gear position is setup you can alter your map based on gear position and setup gear dependent kill times when using a quickshifter.

Analog-

This input is for a 0-5v signal such as engine temp, boost, etc. Once this input is established you can alter your fuel curve based on this input in the control center software.

Crank-

Do **NOT** connect anything to this port unless instructed to do so by Dynojet. It is used to transfer crank trigger data from one module to another.

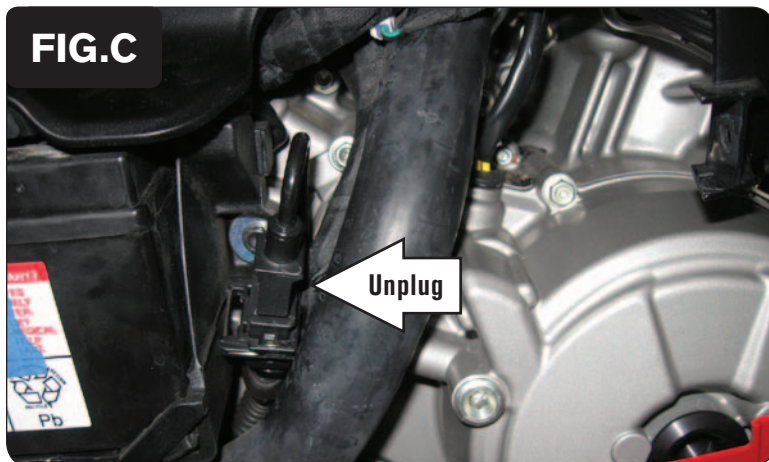
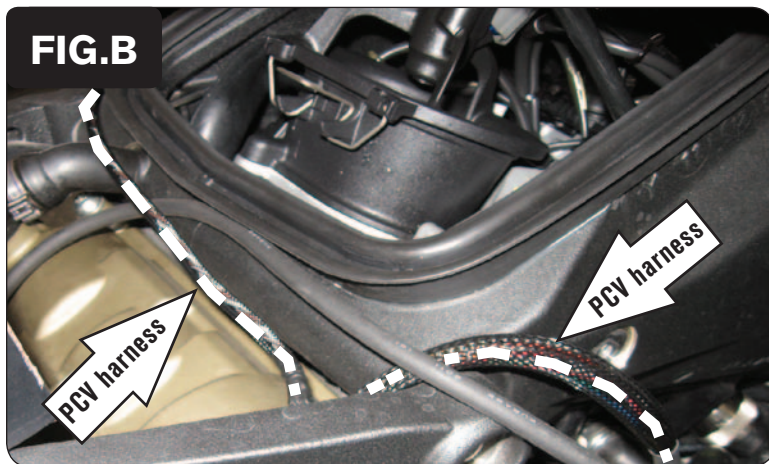
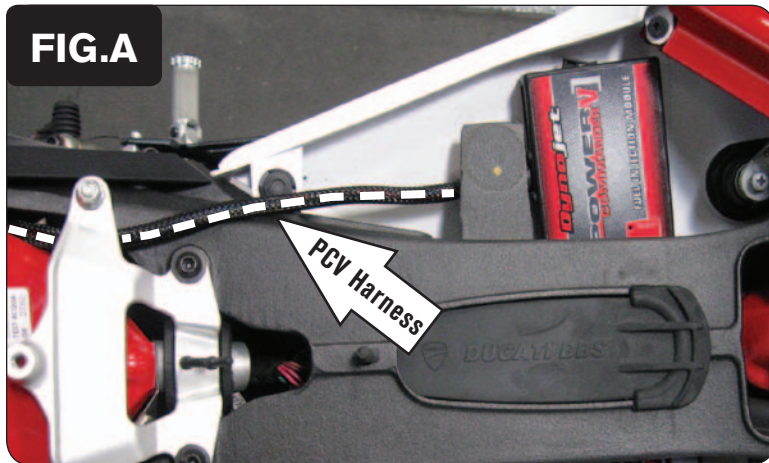

- 1 Remove the rider's seat and remove the left and right side mid-fairings.
- 2 Prop the fuel tank up.
- 3 Using the supplied Velcro strips, secure the PCV module to the body work under the rider's seat on the right side of the frame (Fig. A).
Use the supplied alcohol swab to clean the surface area prior to applying the Velcro.
- 4 Route the PCV wiring harness forward along the inside of right frame rail.
- 5 Route the PCV harness branch with the pair of 3-pin connectors and the single ground wire with the 6mm ring lug across the back of the airbox and down the left side of the bike.
- 6 Route the other branch with the round connectors down the right side of the bike towards the ECU compartment (Fig. B).
- 7 Locate and unplug the connector pair for the bike's Crank Position Sensor (Fig. C).
This is a pair of BLACK 3-pin connectors on the left side of the bike, just rear of the bike's battery.

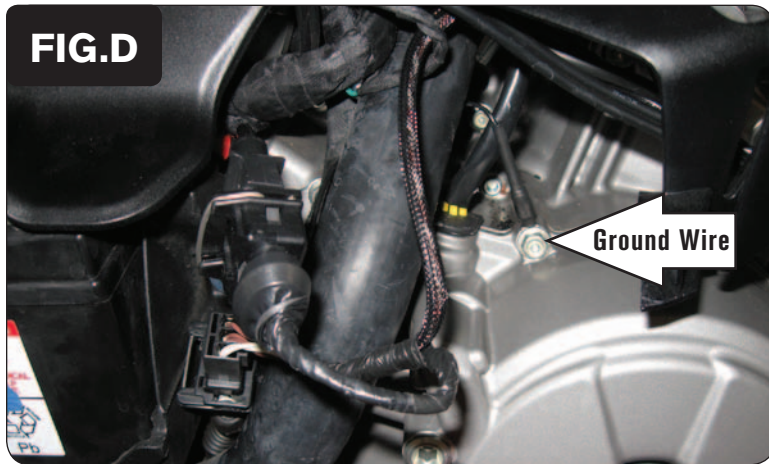

- 8 Plug the PCV wiring harness in-line of the stock Crank Position Sensor connectors (Fig. D).
- 9 Secure the ground wire of the PCV wiring harness with the 6mm ring lug to the engine case bolt shown in Figure D.

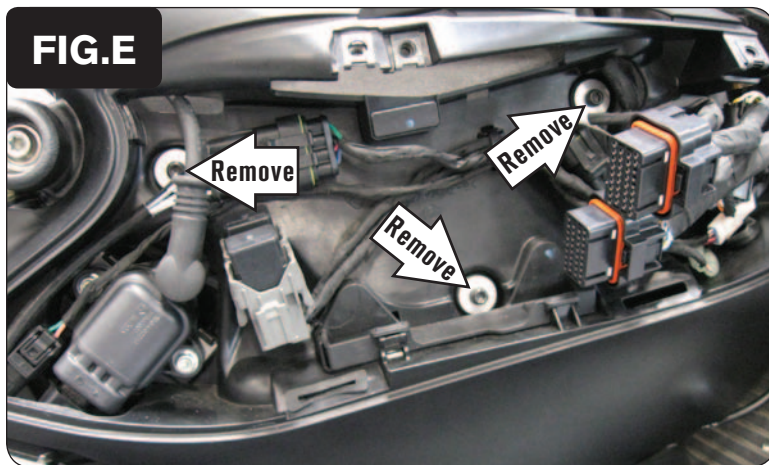

- 10 Remove the lid of the ECU compartment on the right side of the bike.
- 11 Remove the ECU.
- 12 Remove the 3 bolts that secure the entire ECU compartment to the frame.

This should allow you to pull the entire ECU compartment away from the bike so that you can access the bike's fuel injector wiring harness on the right side of the airbox.

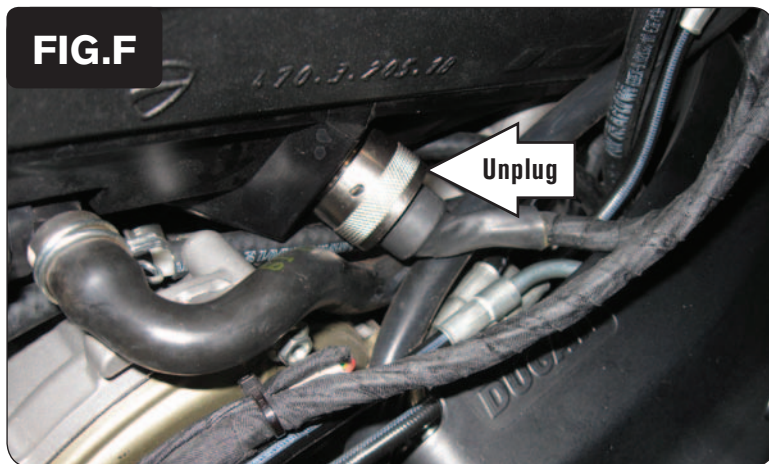

- 13 Locate and unplug the stock fuel injector wiring harness from the right side of the bike's airbox.

FIG.G



- 14 Plug the PCV wiring harness in-line of the stock fuel injector wiring harness connectors (Fig. G).
- 15 Reinstall the ECU compartment, the ECU, the lid, the seats, the fuel tank, and all body work.

Note: The PCV does NOT override the stock closed loop area.

This PCV only allows for tuning the fuel tables in “Cylinder Advanced” mode. You will see fuel tables for Cylinders 1-4, even though this is only a 2 cylinder bike model.

The Cylinder 1 fuel table will adjust the fueling of the Front Cylinder’s Primary Fuel Injector.

The Cylinder 2 fuel table will adjust the fueling of the Rear Cylinder’s Primary Fuel Injector.

The Cylinder 3 fuel table will adjust the fueling of the Front Cylinder’s Secondary Fuel Injector.

The Cylinder 4 fuel table will adjust the fueling of the Rear Cylinder’s Secondary Fuel Injector.