

[POWER COMMANDER V]

2007-2012 Honda CBR600RR

Installation Instructions



PARTS LIST

- 1 Power Commander
- 1 USB Cable
- 1 Installation Guide
- 2 Power Commander Decals
- 2 Dynojet Decals
- 2 Velcro strips
- 1 Alcohol swab

THE IGNITION MUST BE TURNED OFF BEFORE INSTALLATION!

THE LATEST POWER COMMANDER SOFTWARE AND MAP FILES CAN BE DOWNLOADED FROM OUR WEB SITE AT:
www.powercommander.com

PLEASE READ ALL DIRECTIONS BEFORE STARTING INSTALLATION

Dynojet

2191 Mendenhall Drive North Las Vegas, NV 89081 (800) 992-4993 www.powercommander.com

POWER COMMANDER V INPUT ACCESSORY GUIDE

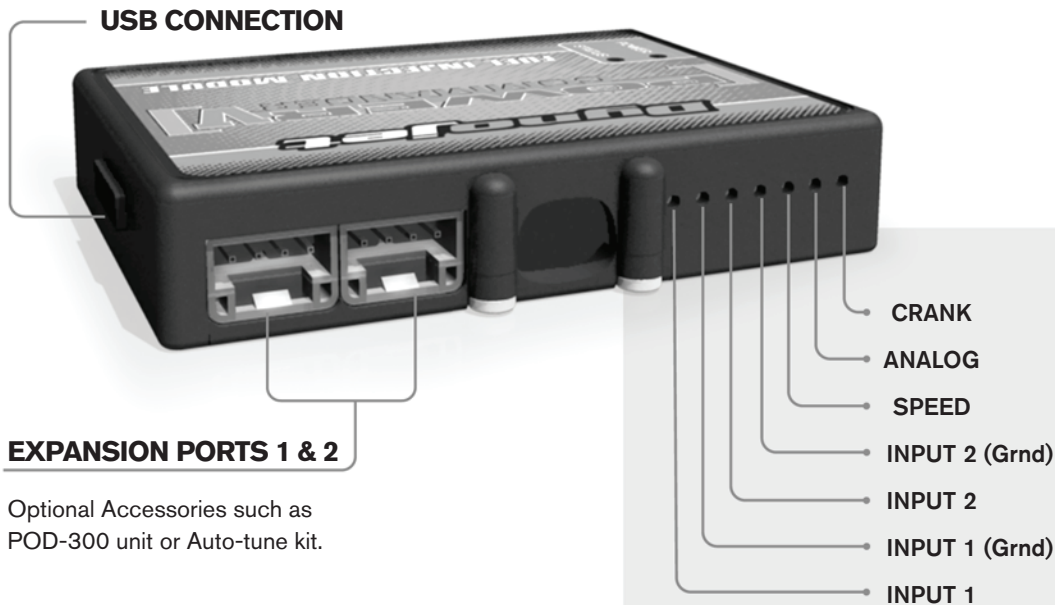

Optional Accessories such as POD-300 unit or Auto-tune kit.

Wire connections:

To input wires into the PCV first remove the rubber plug on the backside of the unit and loosen the screw for the corresponding input. Using a 22-24 gauge wire strip about 10mm from its end. Push the wire into the hole of the PCV until it stops and then tighten the screw. Make sure to reinstall the rubber plug.

NOTE: If you tin the wires with solder it will make inserting them easier.

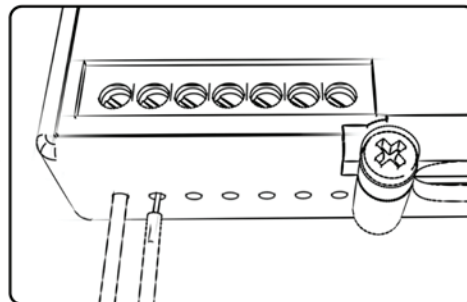

ACCESSORY INPUTS

Map -

(Input 1 or 2) The PCV has the ability to hold 2 different base maps. You can switch on the fly between these two base maps when you hook up a switch to the MAP inputs. You can use any open/close type switch. The polarity of the wires is not important. When using the Autotune kit one position will hold a base map and the other position will let you activate the learning mode. When the switch is "CLOSED" Autotune will be activated. (Set to Switch Input #1 by default.)

Shifter-

(Input 1 or 2) These inputs are for use with the Dynojet quickshifter. Insert the wires from the Dynojet quickshifter into the SHIFTER inputs. The polarity of the wires is not important. (Set to Switch Input #2 by default.)

Speed-

If your application has a speed sensor then you can tap into the signal side of the sensor and run a wire into this input. This will allow you to calculate gear position in the Control Center Software. Once gear position is setup you can alter your map based on gear position and setup gear dependent kill times when using a quickshifter.

Analog-

This input is for a 0-5v signal such as engine temp, boost, etc. Once this input is established you can alter your fuel curve based on this input in the control center software.

Crank-

Do **NOT** connect anything to this port unless instructed to do so by Dynojet. It is used to transfer crank trigger data from one module to another.

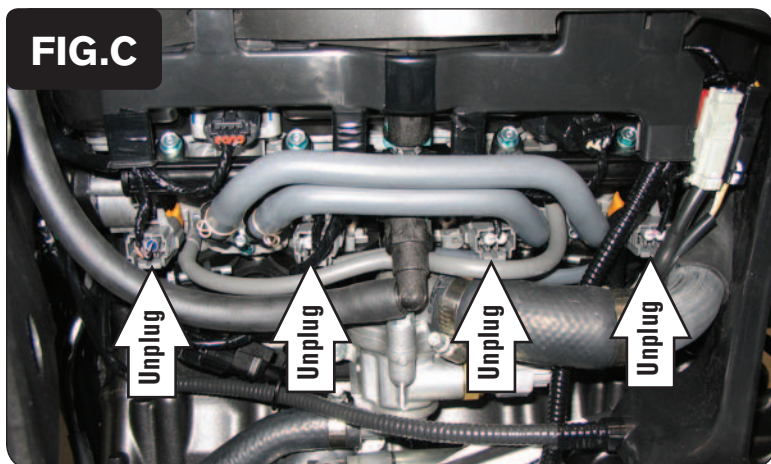
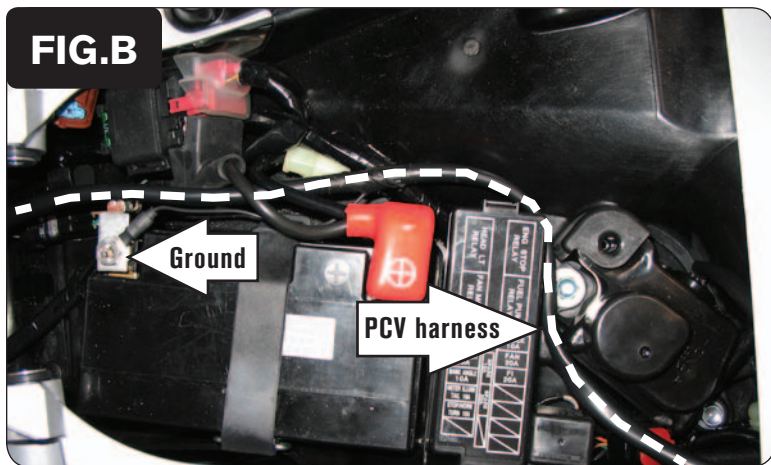
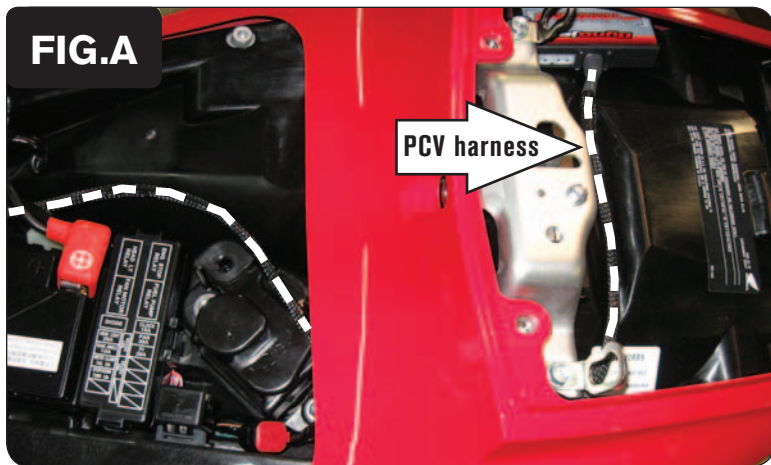

- 1 Remove the main seat and the passenger seat.
- 2 Remove the fuel tank cover.
- 3 Remove the left hand side fairing.
- 4 Prop the fuel tank up.
- 5 Lay the PCV in the tail section temporarily and route the harness through the tail section (Fig. A).

Removing the 4 bolts that hold the tail section in place will make this easier.

- 6 Route the harness towards the throttle bodies.
- 7 Secure the PCV ground wire with the small ring lug to the negative (-) terminal of the bike's battery (Fig. B).

- 8 Unplug the stock wiring harness from the LOWER primary fuel injectors (Fig. C).

*This bike model has UPPER Secondary Fuel Injectors on the top of the airbox and LOWER Primary Fuel Injectors on the throttle bodies. Make sure that the PCV is being connected to the LOWER Primary Fuel Injectors on the throttle bodies; and **NOT** the UPPER Secondary Fuel Injectors on the top of the airbox.*

FIG.D

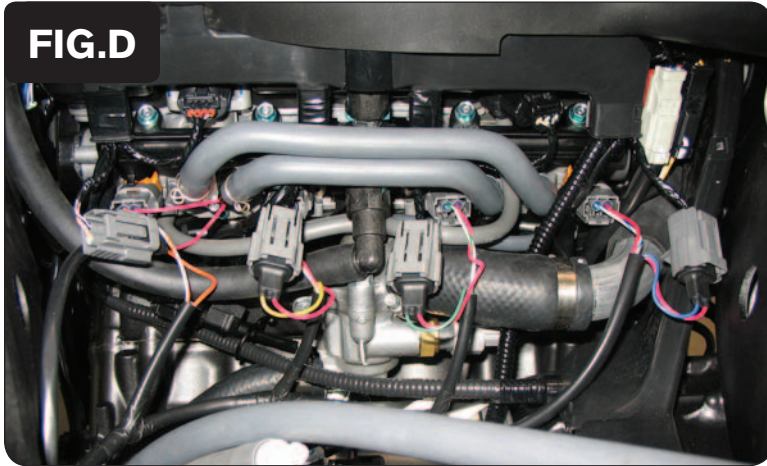

- 9 Plug the PCV wiring harness in-line of the Lower Primary Fuel Injectors and the stock wiring harness (Fig. D).

The pair of PCV leads with ORANGE colored wires go in-line of the #1 Cylinder (left-most) Fuel Injector.

The pair of PCV leads with YELLOW colored wires go in-line of the #2 Cylinder Fuel Injector.

The pair of PCV leads with GREEN colored wires go in-line of the #3 Cylinder Fuel Injector.

The pair of PCV leads with BLUE colored wires go in-line of the #4 Cylinder (right-most) Fuel Injector.

FIG.E

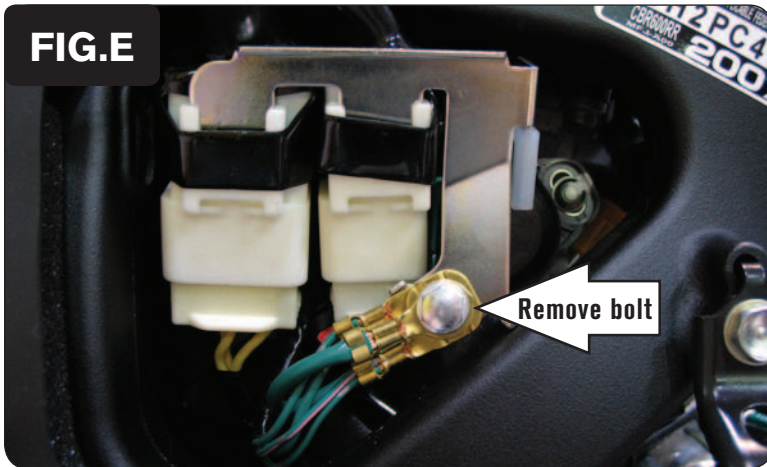

- 10 Remove the bolt that holds the ground wires and the bracket for the alternator connectors to the frame on the left-hand side of the bike (Fig. E).

This allows access to the bike's Throttle Position Sensor connector.

FIG.F

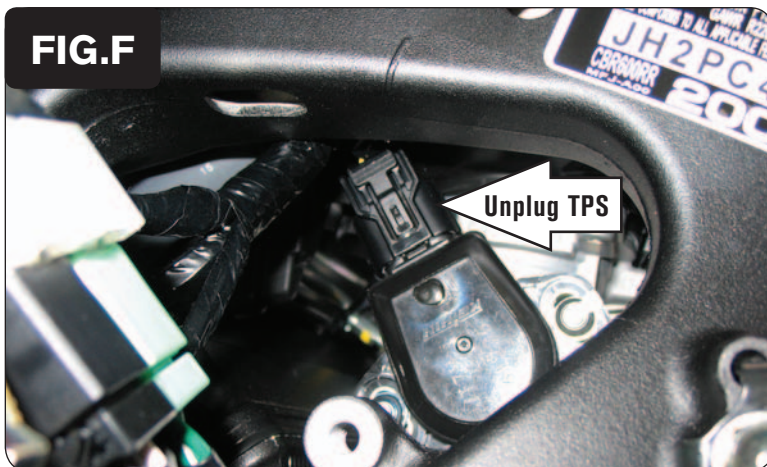

- 11 Unplug the stock wiring harness from the bike's Throttle Position Sensor (Fig. F).

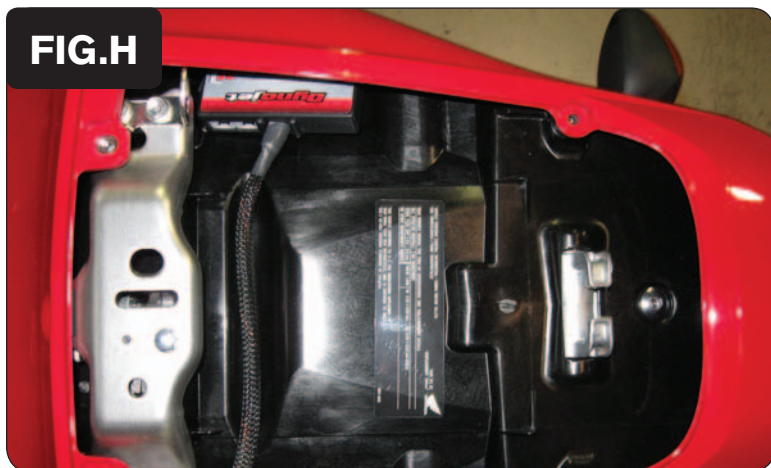

- 12 Plug the pair of BLACK 3-pin connectors from the PCV wiring harness in-line of the bike's Throttle Position Sensor and the stock wiring harness (Fig. G).
- 13 Reinstall the alternator connector bracket and stock ground wires to the frame.

- 14 Using the supplied Velcro, secure the PCV module in the tail section (Fig. H).
Clean both surfaces with the supplied alcohol swab prior to applying the Velcro adhesive.
- 15 Lower the fuel tank and bolt it back into position.
- 16 Reinstall the bodywork.

Note: This unit comes preloaded by default with a map for a stock 2009-2012 model. If this does not fit your setup you can download more maps from www.powercommander.com.

Optional inputs:

Speed - PINK/GREEN wire from vehicle speed sensor, located at the top of the engine case near the back of the starter. This wire can also be found on the GREY ECU connector.

Engine Temperature - BLUE/YELLOW wire of the coolant temperature sensor located at the rear of the cylinders between cylinders #3 and #4. This wire can also be found on the GREY ECU connector.

12v source for Auto-tune - GREEN/YELLOW wire of the tail light connector.