

[POWER COMMANDER V]

2003-2006 Honda CBR600RR

Installation Instructions



PARTS LIST

- 1 Power Commander
- 1 USB Cable
- 1 Installation Guide
- 2 Power Commander Decals
- 2 Dynojet Decals
- 2 Velcro strips
- 1 Alcohol swab

**THE IGNITION MUST BE TURNED
OFF BEFORE INSTALLATION!**

THE LATEST POWER COMMANDER
SOFTWARE AND MAP FILES CAN BE
DOWNLOADED FROM OUR WEB SITE AT:
www.powercommander.com

PLEASE READ ALL DIRECTIONS BEFORE STARTING INSTALLATION

Dynojet

2191 Mendenhall Drive North Las Vegas, NV 89081 (800) 992-4993 www.powercommander.com

POWER COMMANDER V INPUT ACCESSORY GUIDE

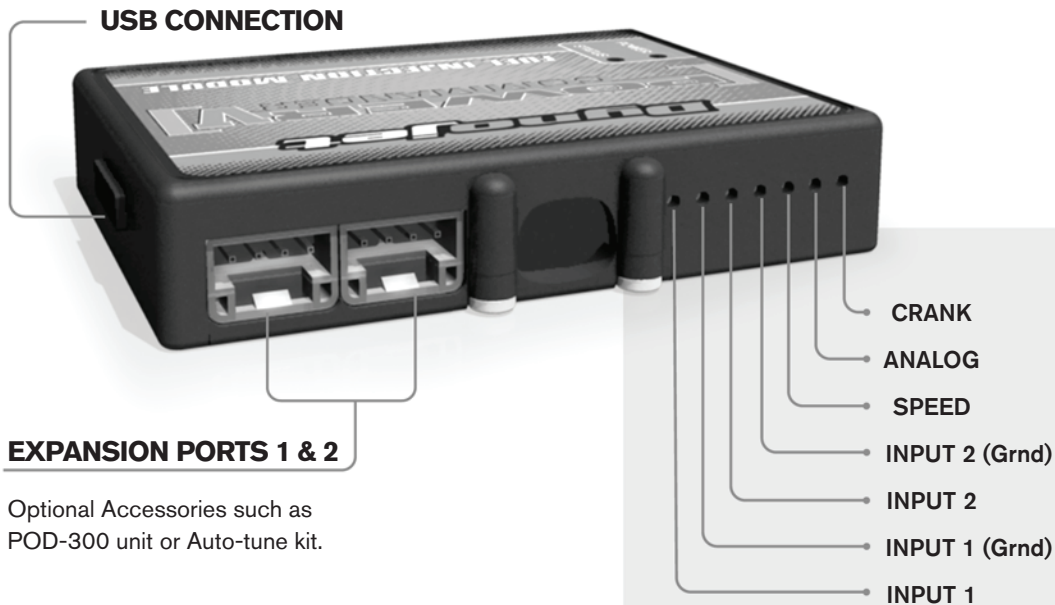

Wire connections:

To input wires into the PCV first remove the rubber plug on the backside of the unit and loosen the screw for the corresponding input. Using a 22-24 gauge wire strip about 10mm from its end. Push the wire into the hole of the PCV until it stops and then tighten the screw. Make sure to reinstall the rubber plug.

NOTE: If you tin the wires with solder it will make inserting them easier.

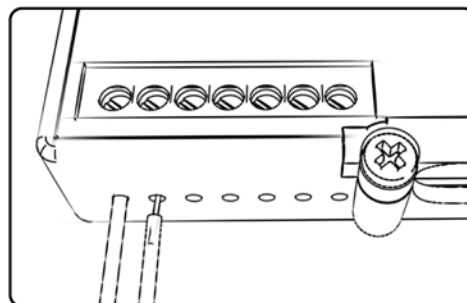

ACCESSORY INPUTS

Map -

(Input 1 or 2) The PCV has the ability to hold 2 different base maps. You can switch on the fly between these two base maps when you hook up a switch to the MAP inputs. You can use any open/close type switch. The polarity of the wires is not important. When using the Autotune kit one position will hold a base map and the other position will let you activate the learning mode. When the switch is "CLOSED" Autotune will be activated. (Set to Switch Input #1 by default.)

Shifter-

(Input 1 or 2) These inputs are for use with the Dynojet quickshifter. Insert the wires from the Dynojet quickshifter into the SHIFTER inputs. The polarity of the wires is not important. (Set to Switch Input #2 by default.)

Speed-

If your application has a speed sensor then you can tap into the signal side of the sensor and run a wire into this input. This will allow you to calculate gear position in the Control Center Software. Once gear position is setup you can alter your map based on gear position and setup gear dependent kill times when using a quickshifter.

Analog-

This input is for a 0-5v signal such as engine temp, boost, etc. Once this input is established you can alter your fuel curve based on this input in the control center software.

Crank-

Do **NOT** connect anything to this port unless instructed to do so by Dynojet. It is used to transfer crank trigger data from one module to another.

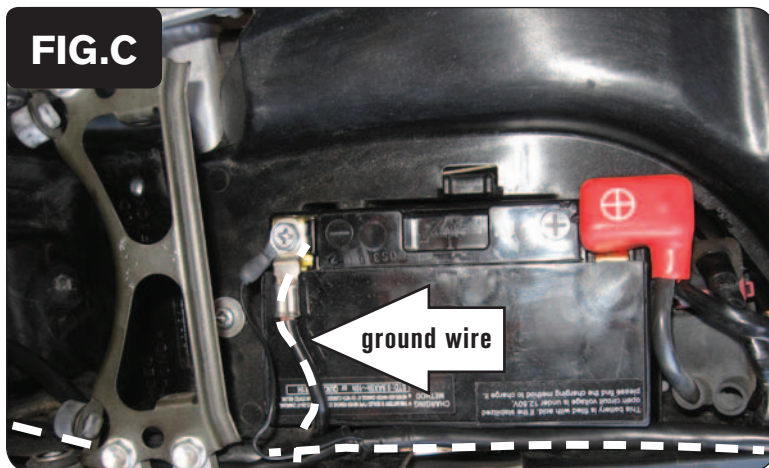
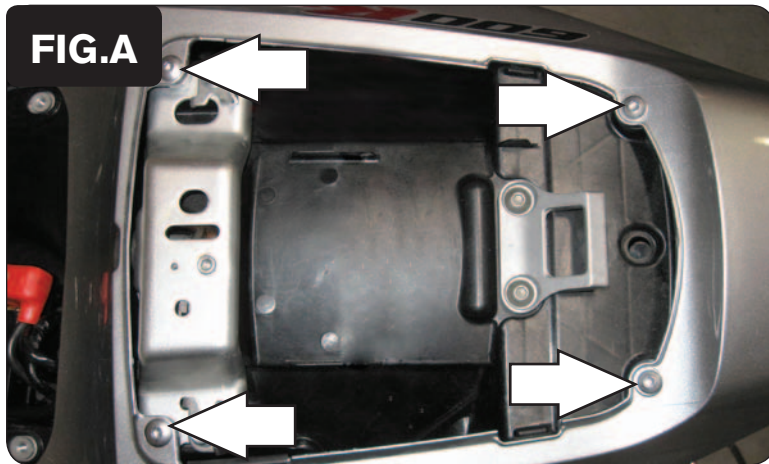

- 1 Remove the main seat and the passenger seat.
- 2 Remove the fuel tank cover.
- 3 Remove the bolts for the rear tail section as shown in Figure A.
- 4 Remove the left hand side mid fairing.
- 5 Lay the PCV in the tail section.
- 6 Route the harness towards the front of the bike. Keep the harness between the outside of the subframe and inside the tail section as shown in Figure B.
- 7 Gently pull out on the lower left hand side of the tail section to allow room for the harness.
- 8 Route the harness between the battery and the subframe and go towards the throttle bodies.
- 9 Remove the fuel tank stop bracket and route the PCV harness underneath it.
- 10 Attach the ground wire of the PCV to the negative side of the battery.
- 11 Reinstall fuel tank bracket. Prop the front of the fuel tank up

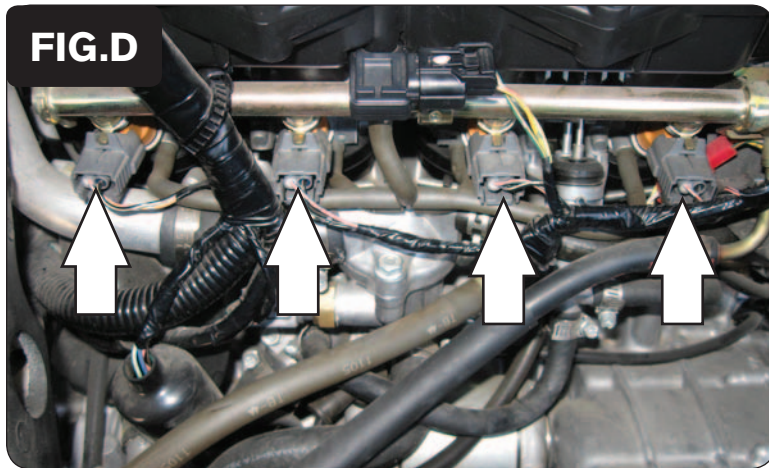

- 12 Unplug the stock wiring harness from the **LOWER** set of injectors (Fig. D)

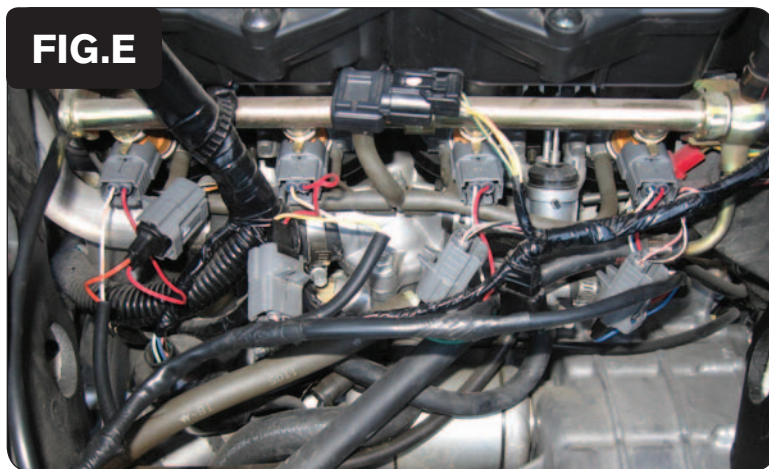

- 13 Attach the connectors from the PCV in-line of the stock wiring harness and the throttle bodies as shown in Figure E.

Connect the ORANGE PCV wires to the far left injector (cylinder #1) and continue to the right.

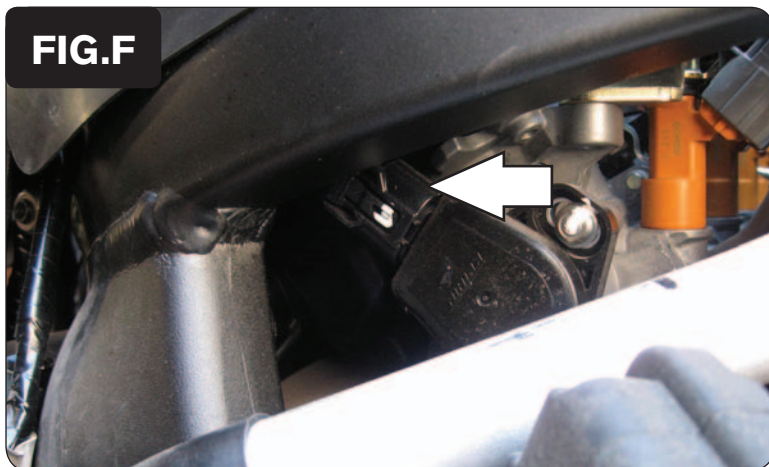

- 14 Locate the Throttle Position Sensor (TPS) connector.
The TPS connector is located on the left hand side of the throttle bodies.
- 15 Unplug the TPS connector.

FIG.G



- 16 Attach the connectors from the PCV in-line of the TPS and stock wiring harness (Fig. G).

FIG.H



- 17 Install the PCV in the tail section as shown in Figure H.
- 18 Lower the fuel tank back into position.
- 19 Reinstall the left hand side mid fairing.
- 20 Reinstall the bolts removed in Figure A.
- 21 Replace the fuel tank cover.
- 22 Reinstall the main seat and the passenger seat.

Note: This unit is shipped with a stock map for the 2003-2004 CBR600RR. If this does not match your setup you can find more maps at www.powercommander.com. The PCV allows you to import PCIII USB maps under the FILE - Import PCIII USB map option.