

# [POWER COMMANDER V]

## FUEL AND IGNITION

### 2010-2013 Honda CRF250R

#### Installation Instructions



#### PARTS LIST

- 1 Power Commander
- 1 USB Cable
- 1 Installation Guide
- 2 Power Commander Decals
- 2 Dynojet Decals
- 2 Velcro strips
- 1 Alcohol swab

**THE IGNITION MUST BE TURNED OFF BEFORE INSTALLATION!**

THE LATEST POWER COMMANDER SOFTWARE AND MAP FILES CAN BE DOWNLOADED FROM OUR WEB SITE AT:  
[www.powercommander.com](http://www.powercommander.com)

**PLEASE READ ALL DIRECTIONS BEFORE STARTING INSTALLATION**

**Dynojet**

2191 Mendenhall Drive North Las Vegas, NV 89081 (800) 992-4993 [www.powercommander.com](http://www.powercommander.com)

# POWER COMMANDER V INPUT ACCESSORY GUIDE

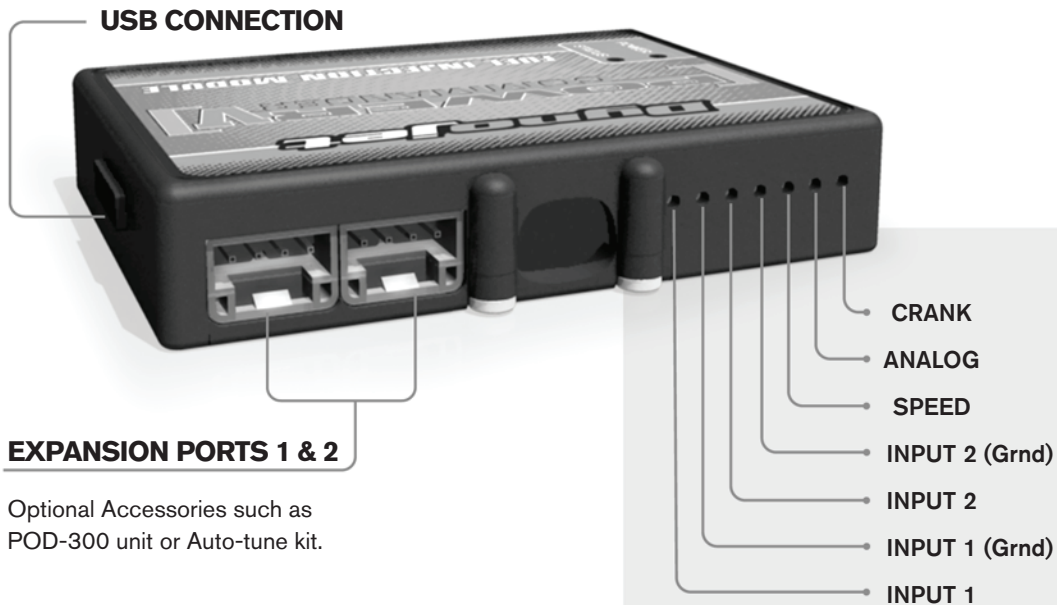

Optional Accessories such as  
POD-300 unit or Auto-tune kit.

## Wire connections:

To input wires into the PCV first remove the rubber plug on the backside of the unit and loosen the screw for the corresponding input. Using a 22-24 gauge wire strip about 10mm from its end. Push the wire into the hole of the PCV until it stops and then tighten the screw. Make sure to reinstall the rubber plug.

NOTE: If you tin the wires with solder it will make inserting them easier.

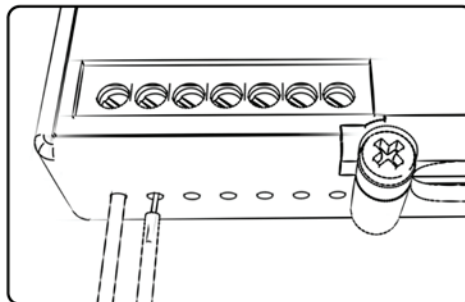

## ACCESSORY INPUTS

### Map -

(Input 1 or 2) The PCV has the ability to hold 2 different base maps. You can switch on the fly between these two base maps when you hook up a switch to the MAP inputs. You can use any open/close type switch. The polarity of the wires is not important. When using the Autotune kit one position will hold a base map and the other position will let you activate the learning mode. When the switch is "CLOSED" Autotune will be activated. (Set to Switch Input #1 by default.)

### Shifter-

(Input 1 or 2) These inputs are for use with the Dynojet quickshifter. Insert the wires from the Dynojet quickshifter into the SHIFTER inputs. The polarity of the wires is not important. (Set to Switch Input #2 by default.)

### Speed-

If your application has a speed sensor then you can tap into the signal side of the sensor and run a wire into this input. This will allow you to calculate gear position in the Control Center Software. Once gear position is setup you can alter your map based on gear position and setup gear dependent kill times when using a quickshifter.

### Analog-

This input is for a 0-5v signal such as engine temp, boost, etc. Once this input is established you can alter your fuel curve based on this input in the control center software.

### Crank-

Do **NOT** connect anything to this port unless instructed to do so by Dynojet. It is used to transfer crank trigger data from one module to another.

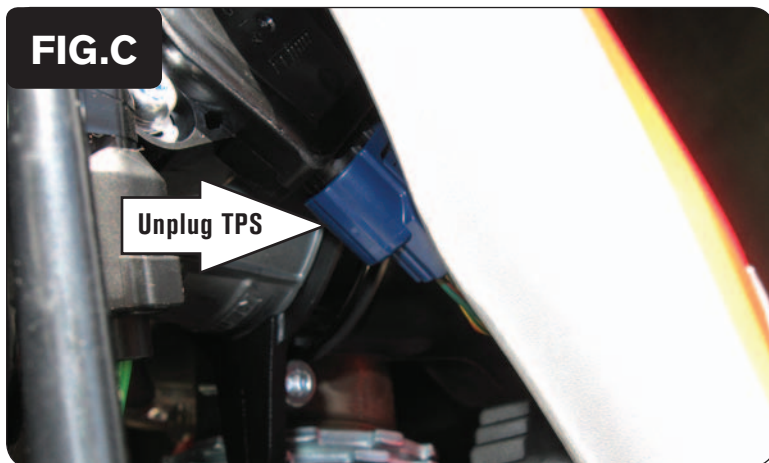
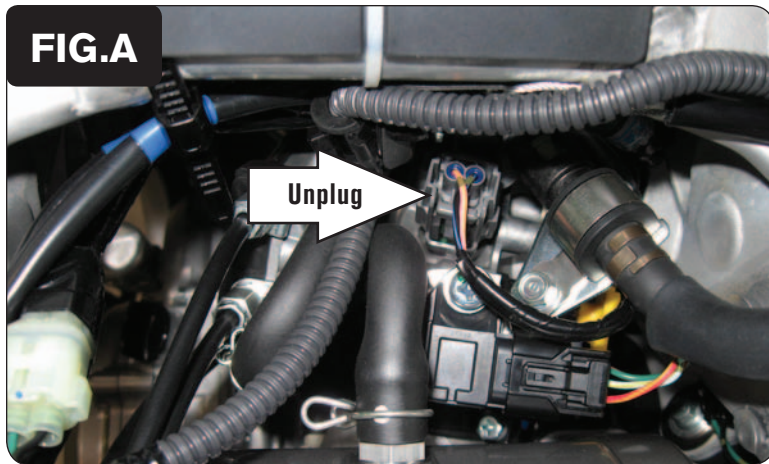

- 1 Remove the seat and fuel tank. Remove left hand side radiator cover.
- 2 Unplug the stock wiring harness from the injector (Fig. A).

- 3 Connect the PCV in-line of the stock wiring harness and the injector (Fig. B).

- 4 Unplug the Throttle Position Sensor harness (Fig. C).

*This connector is located on the left side of the throttle body to the inside of the frame. The MAP sensor uses this same connector and is located on top of the throttle body. Make sure you do NOT connect to the MAP sensor.*

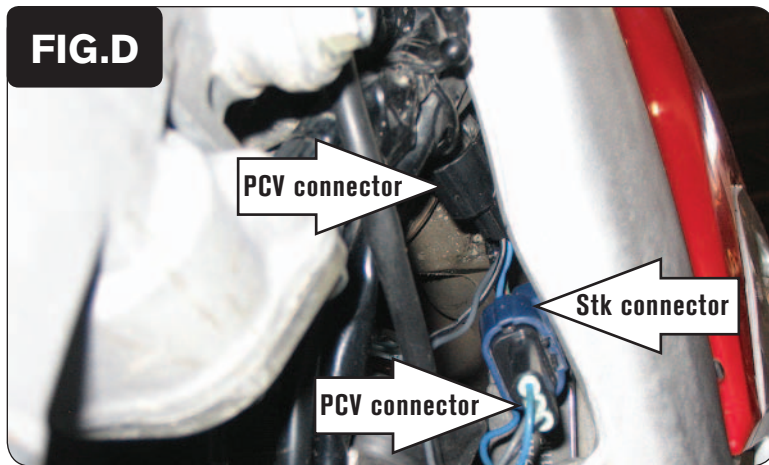

- 5 Plug the PCV harness in-line of the stock TPS and wiring harness (Fig. D).

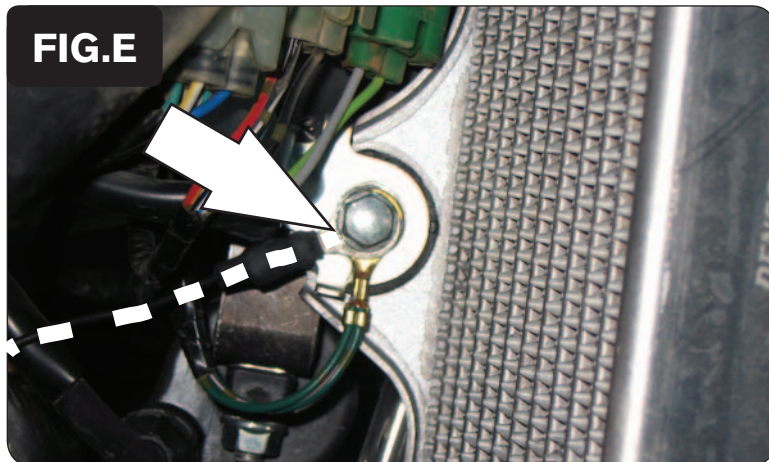

- 6 Attach the ground wire of the PCV to the stock ground location (Fig. E).  
*This is the mounting tab for the right side radiator.*

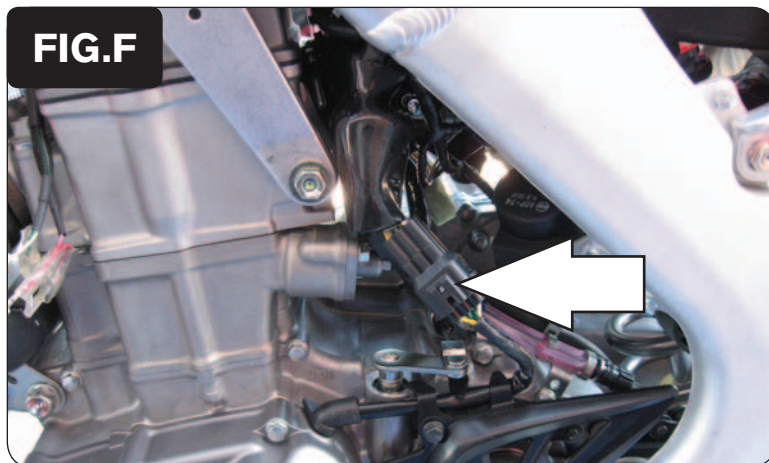

- 7 Unplug the crank position sensor connector (Fig. F).  
*This is a BLACK 6-pin connector on the left side of the motorcycle.*

**FIG.G**

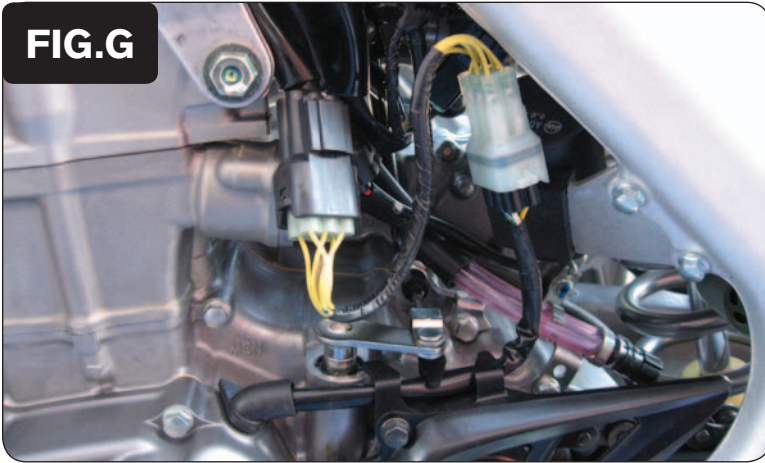

- 8 Plug the PCV in-line of the stock wiring harness and crank position sensor (Fig. G).

**FIG.H**

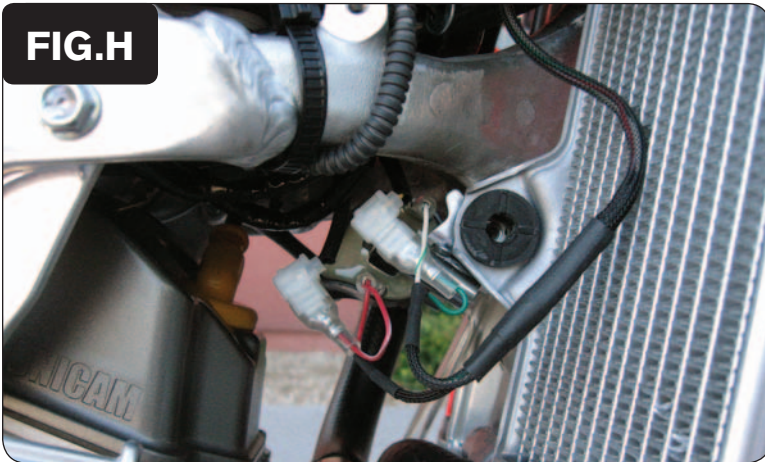

- 9 Plug the PCV in-line of the stock wiring harness and the ignition coil (Fig. H).  
*The GREEN wires of the PCV go in-line of the stock YELLOW wire.*  
*The RED wires of the PCV go in-line of the stock BLACK wire.*

**FIG.I**



- 10 Lay the PCV on the left, inside of the frame, near the radiator.
- 11 Reinstall the fuel tank making sure that the PCV harness does not get pinched.
- 12 Secure the PCV to the fuel tank using the supplied Velcro (Fig. I). Make sure to use the alcohol swab to clean both surfaces before attaching.
- 13 Install the rubber plugs into the ports of the PCV. Install bodywork and seat.