

[POWER COMMANDER V]

FUEL and IGNITION **2014 Honda Pioneer** Installation Instructions



PARTS LIST

- 1 Power Commander
- 1 USB Cable
- 1 Installation Guide
- 2 Power Commander Decals
- 2 Dynojet Decals
- 2 Velcro strips
- 1 Alcohol Swab
- 3 Posi-taps

**THE IGNITION MUST BE TURNED
OFF BEFORE INSTALLATION!**

THE LATEST POWER COMMANDER
SOFTWARE AND MAP FILES CAN BE
DOWNLOADED FROM OUR WEB SITE AT:
www.powercommander.com

PLEASE READ ALL DIRECTIONS BEFORE STARTING INSTALLATION

Dynojet

2191 Mendenhall Drive North Las Vegas, NV 89081 (800) 992-4993 www.powercommander.com

POWER COMMANDER V INPUT ACCESSORY GUIDE

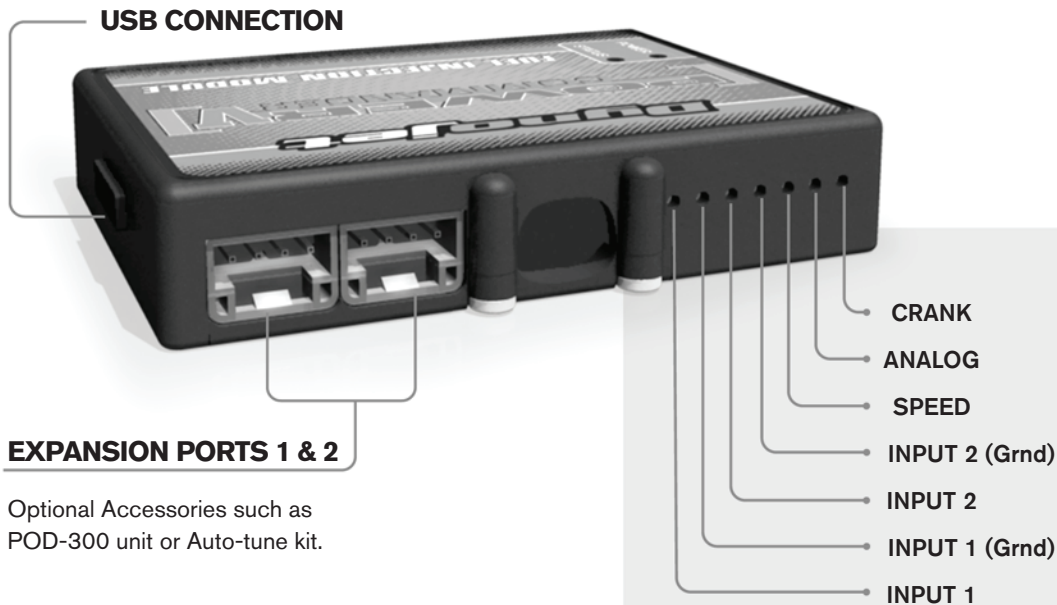

Optional Accessories such as
POD-300 unit or Auto-tune kit.

PCV Wire Connections

1. Remove the rubber plug on the backside of the unit and loosen the screw for the corresponding input.
2. Using a 22-24 gauge wire, strip about 10mm from its end.
3. Push the wire into the hole of the PCV until it stops and then tighten the screw.
4. Make sure to reinstall the rubber plug.

Note: If you tin the wires with solder it will make inserting them easier.

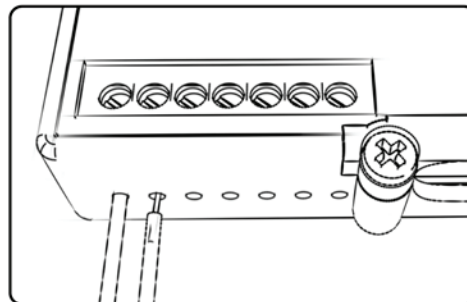

ACCESSORY INPUTS

Map-

(Input 1 or 2) The PCV has the ability to hold two different base maps. You can switch on the fly between these two base maps when you connect a switch to the MAP inputs. You can use any open/close type switch. The polarity of the wires is not important. When using the Autotune kit, one position will hold a base map and the other position will let you activate the learning mode. When the switch is "CLOSED" Autotune will be activated. (Set to Switch Input #1 by default.)

Shifter-

(Input 1 or 2) Not used for continuously variable transmissions. (Set to Switch Input #2 by default.)

Speed-

If your application has a speed sensor then you can tap into the signal side of the sensor and run a wire into this input. This will allow you to calculate gear position in the Control Center Software. Once gear position is setup you can alter your map based on gear position and setup gear dependent kill times when using a quickshifter.

Analog-

This input is for a 0-5v signal such as engine temp, boost, etc. Once this input is established you can alter your fuel curve based on this input in the control center software.

Crank-

Do **NOT** connect anything to this port unless instructed to do so by Dynojet. It is used to transfer crank trigger data from one module to another.



FIG.A

- 1 Lift the cargo bed.
- 2 Using the supplied Velcro, secure the PCV module next to the Ignition Coil in the rear left corner of the engine compartment (Fig. A).

Clean both surfaces with the supplied alcohol swab prior to applying the Velcro adhesive.

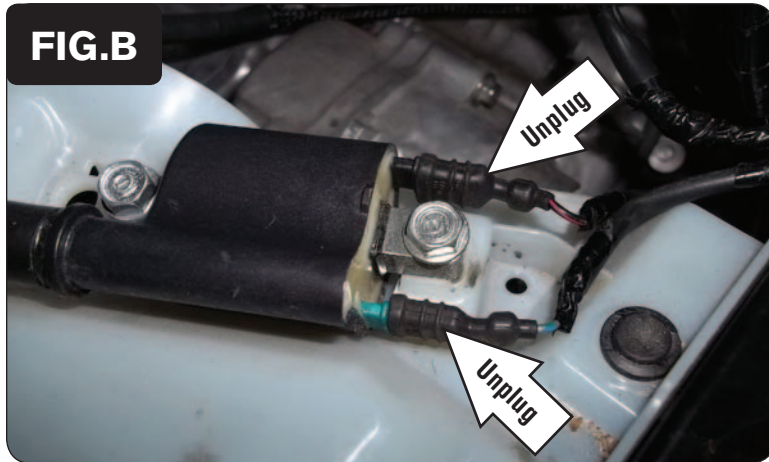

FIG.B

- 3 Unplug the stock BLACK/RED wire from the BLACK coil tab and unplug the stock GREEN/BLUE wire from the GREEN coil tab (Fig. B).

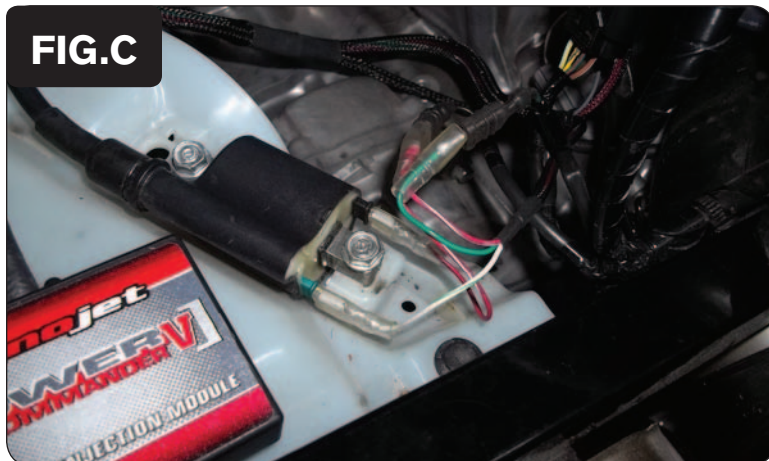
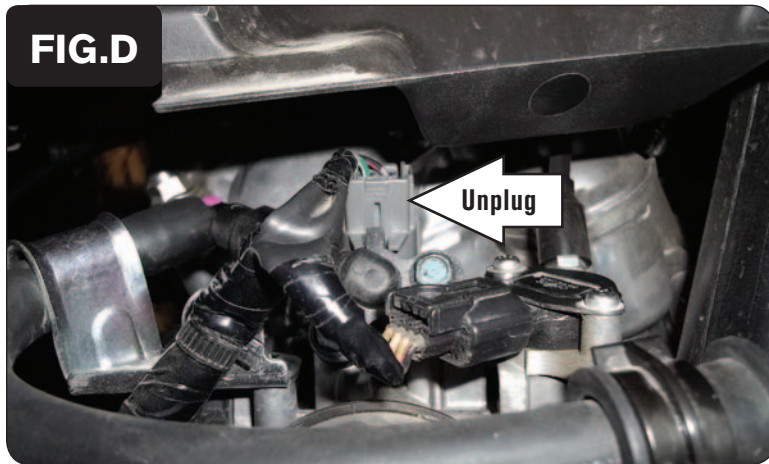

FIG.C

- 4 Plug the pair of leads on the PCV wiring harness with RED/WHITE colored wires in-line of the BLACK coil tab and the stock BLACK/RED wire.
- 5 Plug the single GREEN wire on the PCV wiring harness with the male spade connector to the stock GREEN/BLUE wire. Plug the single WHITE/GREEN wire on the PCV wiring harness with the female spade on to the GREEN coil tab (Fig. C).

Make sure to slide the insulators on these spade connectors over any exposed metal.



- 6 Locate and unplug the stock wiring harness from the Fuel Injector at the top of the throttle body (Fig. D).



- 7 Plug the pair of PCV wiring harness leads with ORANGE colored wires in-line of the Fuel Injector and the stock wiring harness (Fig. E).

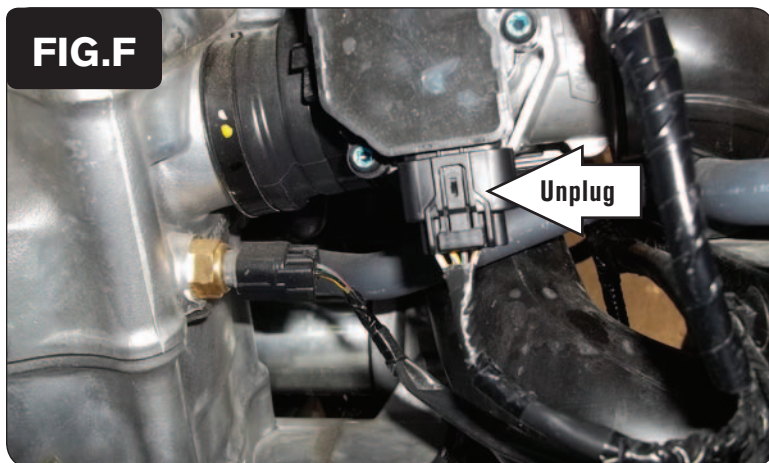

- 8 Locate and unplug the stock Throttle Position Sensor (Fig. F).

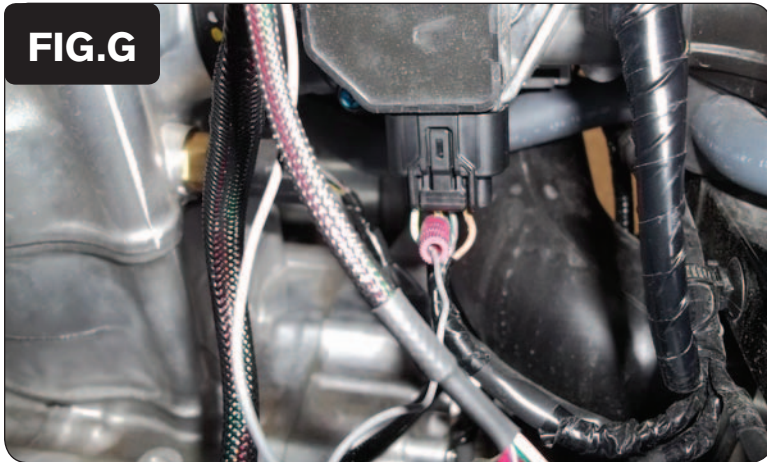

FIG.G

- 9 Pull back some of the wiring harness sheathing on this stock connector to expose the wires.
- 10 Use one of the supplied Posi-taps to attach the PCV single unterminated GREY wire to the stock YELLOW/BLUE wire on the TPS connector.
- 11 Plug the stock TPS connector back on to the TPS (Fig. G).

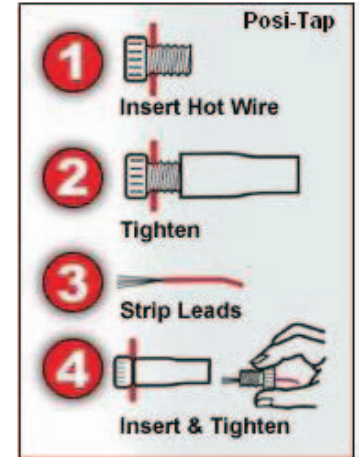

FIG.H

- 12 Locate the Generator/Crank Position Sensor connector towards the rear of the engine (Fig. H).

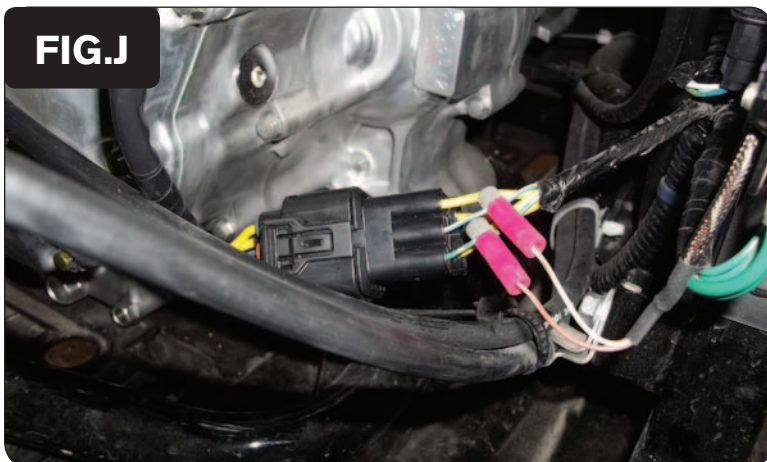
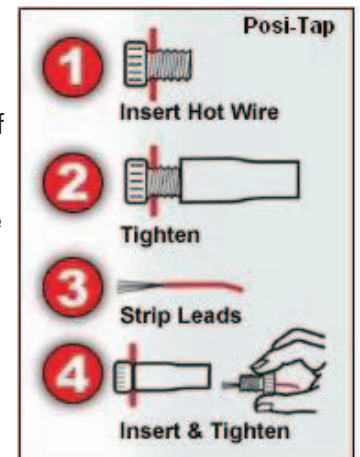
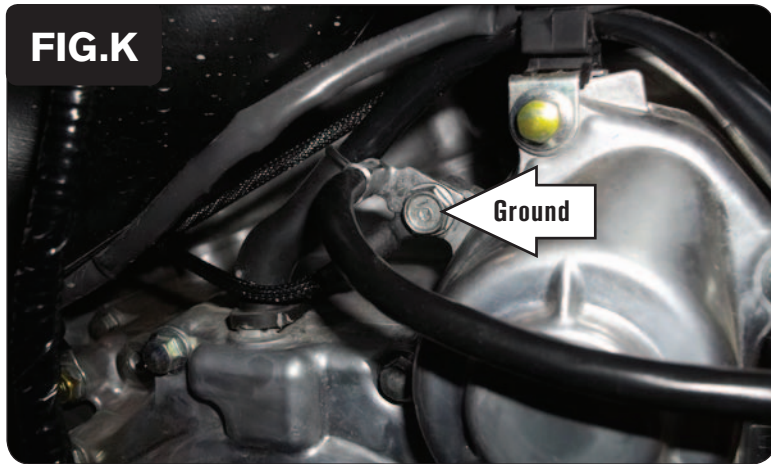

FIG.J

- 13 Use one of the Posi-taps to attach the single unterminated WHITE/BROWN wire on the PCV wiring harness to the stock BLUE/YELLOW wire of the Crank Position Sensor.
- 14 Use the last remaining Posi-tap to attach the single unterminated BROWN/WHITE wire on the PCV wiring harness to the stock GREEN wire of the Crank Position Sensor (Fig. J).

It is recommended to use dielectric grease on these Posi-tap connections.





- 15 Secure the PCV ground wire with the small ring lug to the starter bolt at the back of the starter (Fig. K).
- 16 Lower the cargo bed.