

# [POWER COMMANDER V]

## FUEL AND IGNITION

### 2014 Honda Foreman 500

#### Installation Instructions



#### PARTS LIST

- 1 Power Commander
- 1 USB Cable
- 1 Installation Guide
- 2 Power Commander Decals
- 2 Dynojet Decals
- 2 Velcro strips
- 1 Alcohol swab
- 1 Posi-tap
- 1 O2 Optimizer

**THE IGNITION MUST BE TURNED OFF BEFORE INSTALLATION!**

THE LATEST POWER COMMANDER SOFTWARE AND MAP FILES CAN BE DOWNLOADED FROM OUR WEB SITE AT:  
[www.powercommander.com](http://www.powercommander.com)

**PLEASE READ ALL DIRECTIONS BEFORE STARTING INSTALLATION**

**Dynojet**

2191 Mendenhall Drive North Las Vegas, NV 89081 (800) 992-4993 [www.powercommander.com](http://www.powercommander.com)

# POWER COMMANDER V INPUT ACCESSORY GUIDE

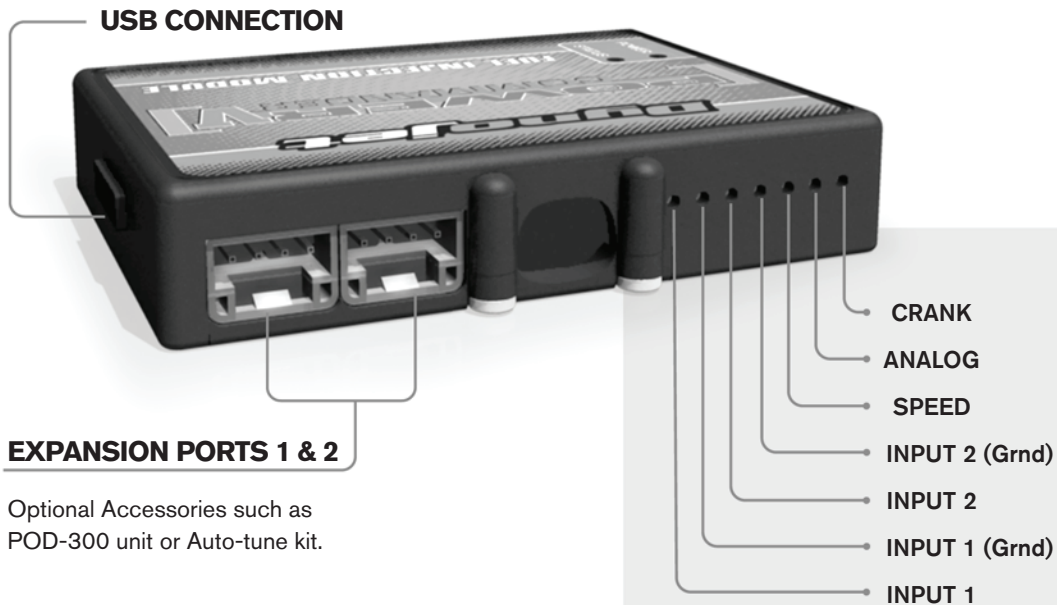

Optional Accessories such as  
POD-300 unit or Auto-tune kit.

## Wire connections:

To input wires into the PCV first remove the rubber plug on the backside of the unit and loosen the screw for the corresponding input. Using a 22-24 gauge wire strip about 10mm from its end. Push the wire into the hole of the PCV until it stops and then tighten the screw. Make sure to reinstall the rubber plug.

NOTE: If you tin the wires with solder it will make inserting them easier.

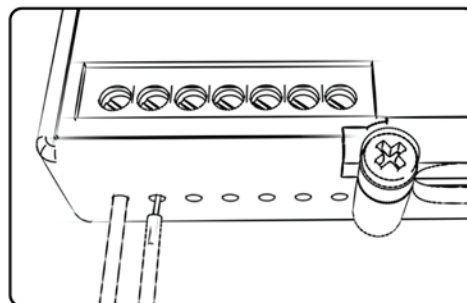

## ACCESSORY INPUTS

### Map -

(Input 1 or 2) The PCV has the ability to hold 2 different base maps. You can switch on the fly between these two base maps when you hook up a switch to the MAP inputs. You can use any open/close type switch. The polarity of the wires is not important. When using the Autotune kit one position will hold a base map and the other position will let you activate the learning mode. When the switch is "CLOSED" Autotune will be activated. (Set to Switch Input #1 by default.)

### Shifter-

(Input 1 or 2) These inputs are for use with the Dynojet quickshifter. Insert the wires from the Dynojet quickshifter into the SHIFTER inputs. The polarity of the wires is not important. (Set to Switch Input #2 by default.)

### Speed-

If your application has a speed sensor then you can tap into the signal side of the sensor and run a wire into this input. This will allow you to calculate gear position in the Control Center Software. Once gear position is setup you can alter your map based on gear position and setup gear dependent kill times when using a quickshifter.

### Analog-

This input is for a 0-5v signal such as engine temp, boost, etc. Once this input is established you can alter your fuel curve based on this input in the control center software.

### Crank-

Do **NOT** connect anything to this port unless instructed to do so by Dynojet. It is used to transfer crank trigger data from one module to another.



- 1 Remove the seat, the battery cover rear of the seat, and the body panels surrounding the ATV's fuel tank (Fig. A).

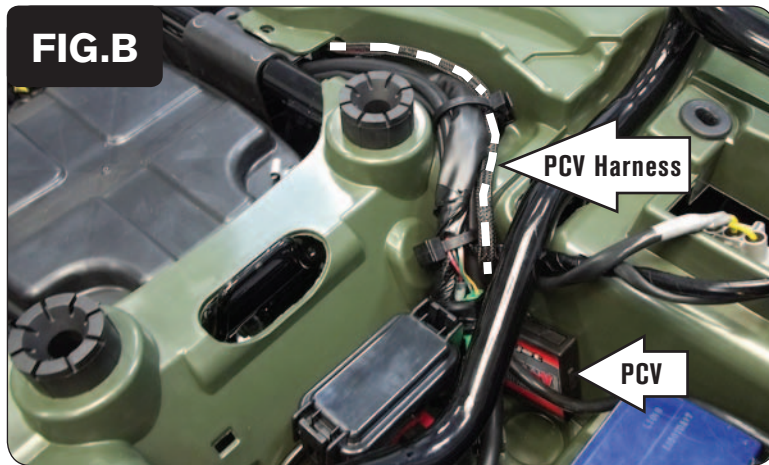

- 2 Using the supplied Velcro, secure the PCV module to the right side of the compartment directly in front of the battery.  
*Clean both surfaces with the supplied alcohol swab prior to applying the Velcro adhesive.*
- 3 Route the PCV wiring harness forward along the right side frame rail following alongside the stock wiring harness and using the stock wiring harness ties to secure the PCV wiring harness (Fig. B).

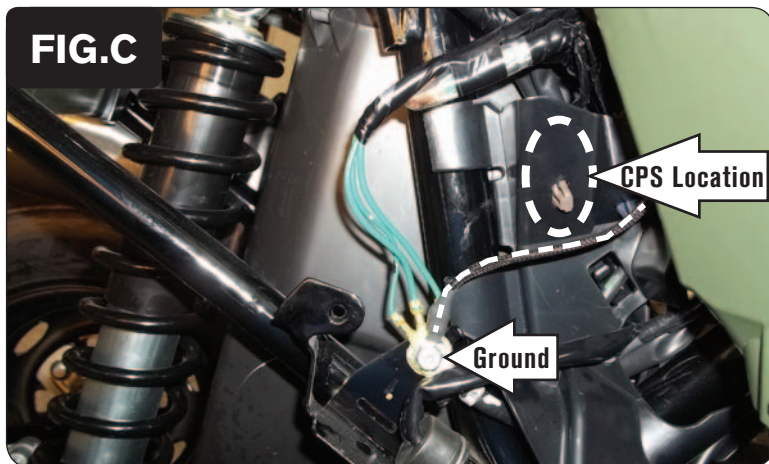

- 4 Route the PCV ring lug and GREY 2-pin connector pair into the right-rear fender well.
- 5 Inside of the right-rear fender well, secure the PCV ring lug to the common ground bolt on the frame.
- 6 Loosen the stock Crank Position Sensor connectors from behind the plastic panel at the location shown in Figure C (dashed oval).

*This is a GREY 2-pin connector pair.*

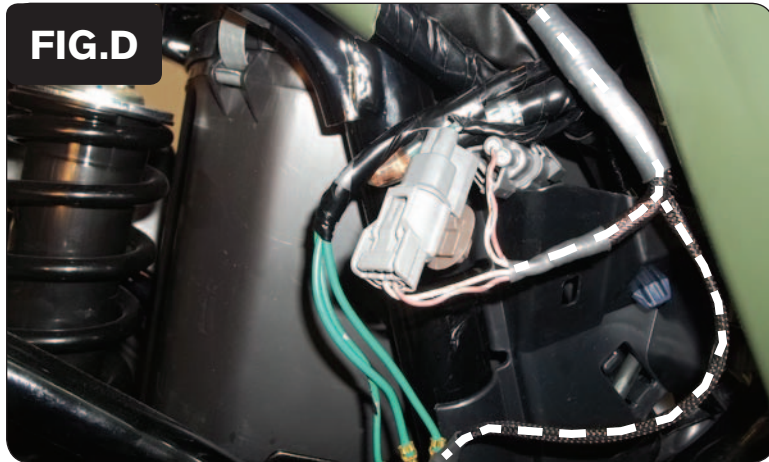

- 7 Plug the pair of GREY 2-pin connectors of the PCV wiring harness in-line of the stock GREY 2-pin connectors for the ATV's Crank Position Sensor (Fig. D).
- 8 Store the 2 connector pairs back behind the plastic panel.
- 9 Route the remaining portion of the PCV wiring harness towards the ATV's throttle body.



- 10 At the top of the throttle body, unplug the stock wiring harness from the ATV's Fuel Injector (Fig. E).

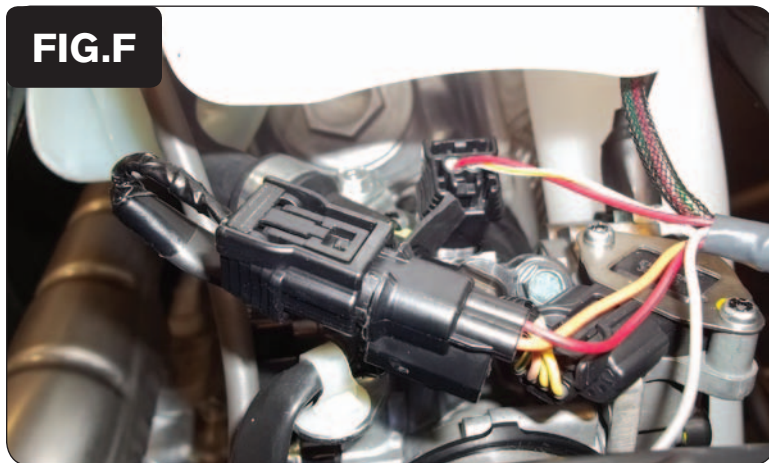

- 11 Plug the PCV wiring harness in-line of the Fuel Injector and the stock wiring harness (Fig. F).

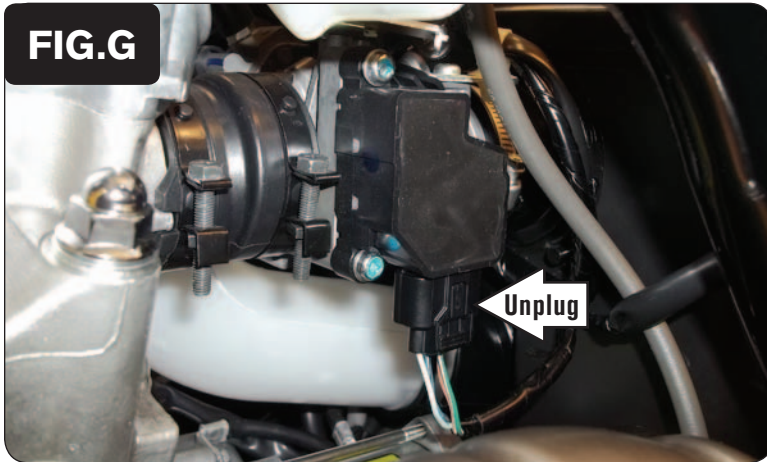

- 12 At the left side of the throttle body, unplug the stock wiring harness from the ATV's Throttle Position Sensor (Fig. G).

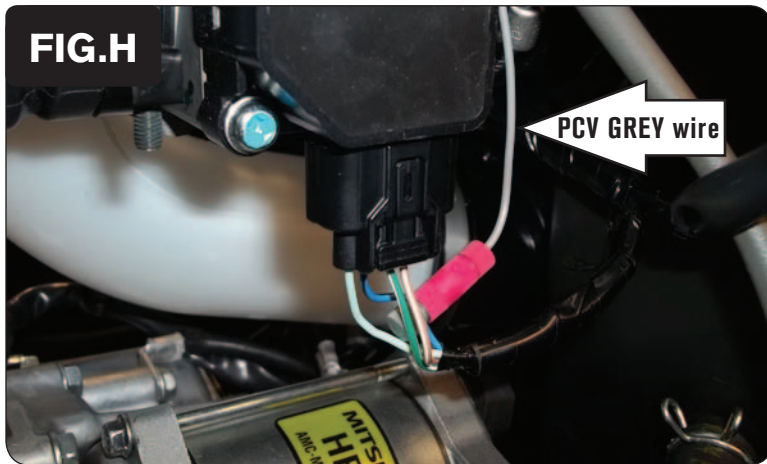

- 13 Use the supplied Posi-tap, to attach the PCV single unterminated GREY wire to the stock BLACK/BLUE wire of the TPS connector.
- 14 After attaching the wire, plug the ATV's stock TPS connector back on to the TPS (Fig. H).

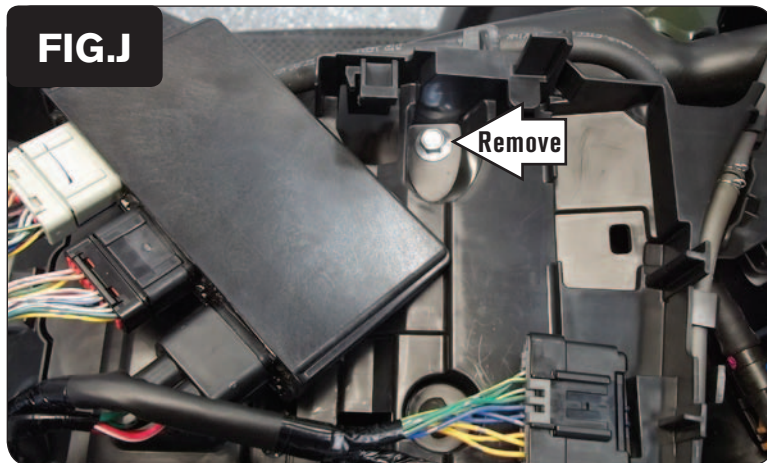
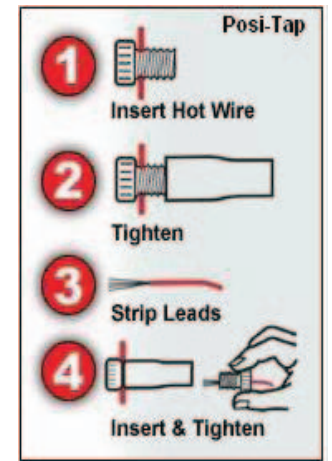

- 15 Pull the ECM rearward and unlatch it from its mounting bracket. Remove the bolt found beneath the ECM (Fig. J).
- This should allow you to lift up on the entire ECM mounting bracket assembly enough to access the Ignition Coil beneath it.*
- 16 Route the PCV wires with spade connectors towards the Ignition Coil.

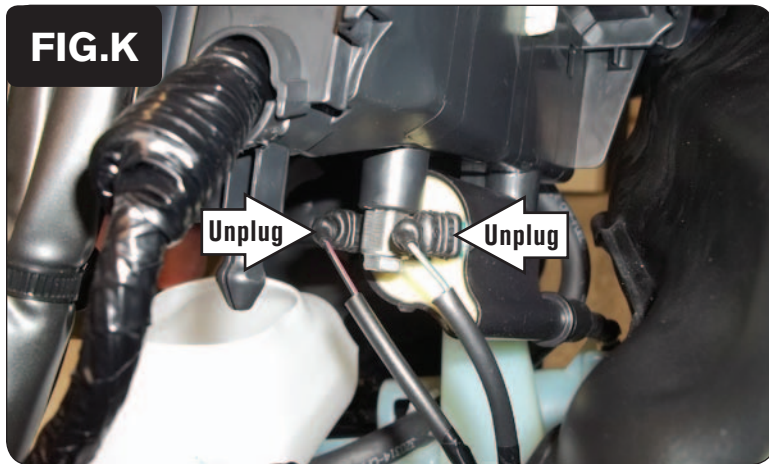

- 17 At the Ignition Coil, unplug the stock BLACK/RED wire from the BLACK coil tab.
- 18 Unplug the stock GREEN/RED wire from the GREEN coil tab (Fig. K).

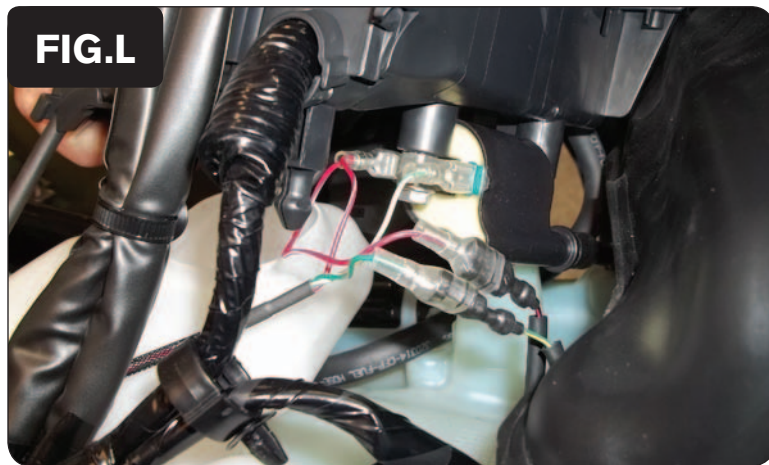

- 19 Plug the RED/WHITE wires of the PCV in-line of the stock BLACK/RED wire and the BLACK coil tab.
- 20 Plug the GREEN wire of the PCV to the stock GREEN/RED wire and the WHITE/GREEN wire of the PCV to the GREEN coil tab.

*Slide the insulators on these spade connections over the spade connectors to avoid causing a short circuit and/or corrosion.*

- 21 Reinstall the ECM mounting bracket and ECM.



- 22 Just left of the airbox, locate and unplug the stock connectors for the ATV's O2 sensor.

*The stock O2 sensor in the exhaust just at the front of the muffler has a cable that can be traced this connector.*

**FIG.N**

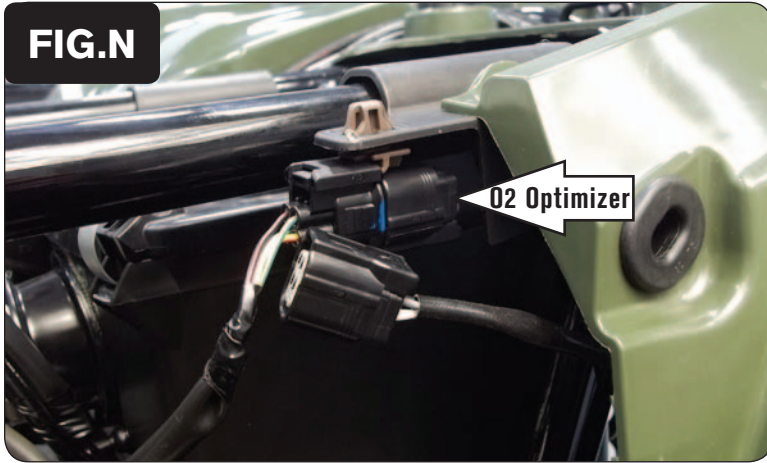

- 23 Plug the supplied O2 Optimizer into the ATV's wiring harness in-place of the stock O2 sensor (Fig. N).

*The stock O2 sensor will no longer be used. It can be removed from the exhaust if desired and if you have a way to plug the hole in the exhaust. If you do leave it in the exhaust, be sure to tie up the wiring harness to keep it off of the hot exhaust.*

- 24 Reinstall the covers over the fuel tank, the battery cover, and the seat.

*\*To see a video demonstration of this install, visit our channel (DynojetResearch) on YouTube.com.\**