

[POWER COMMANDER V]

2012 Kawasaki KX250F

Installation Instructions



PARTS LIST

- 1 Power Commander
- 1 USB Cable
- 1 Installation Guide
- 2 Power Commander Decals
- 2 Dynojet Decals
- 2 Velcro strips
- 1 Alcohol swab

THE IGNITION MUST BE TURNED OFF BEFORE INSTALLATION!

THE LATEST POWER COMMANDER SOFTWARE AND MAP FILES CAN BE DOWNLOADED FROM OUR WEB SITE AT:
www.powercommander.com

PLEASE READ ALL DIRECTIONS BEFORE STARTING INSTALLATION

Dynojet

2191 Mendenhall Drive North Las Vegas, NV 89081 (800) 992-4993 www.powercommander.com

POWER COMMANDER V INPUT ACCESSORY GUIDE

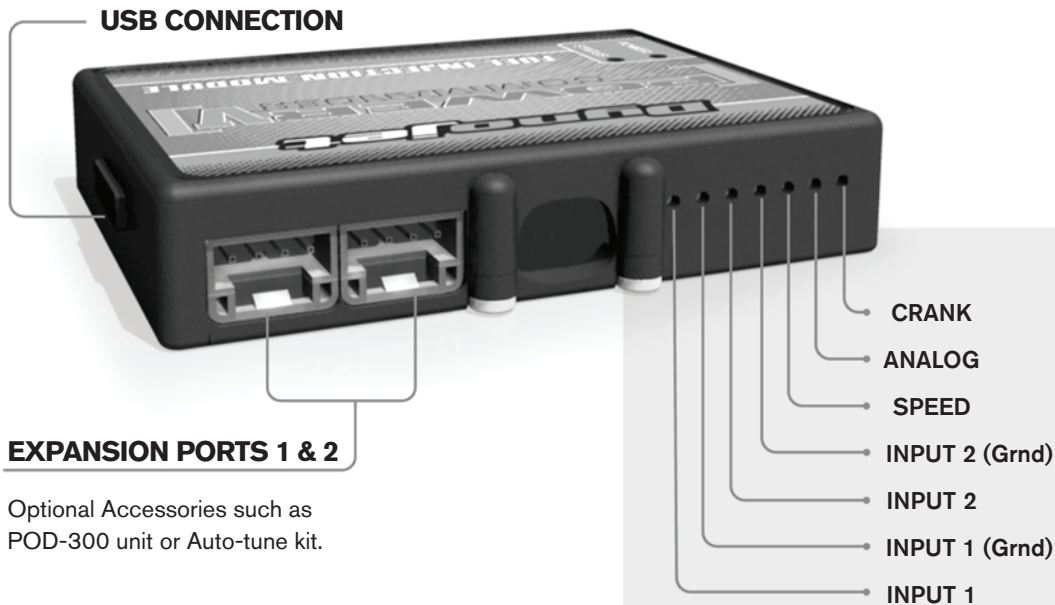

EXPANSION PORTS 1 & 2

Optional Accessories such as POD-300 unit or Auto-tune kit.

Wire connections:

To input wires into the PCV first remove the rubber plug on the backside of the unit and loosen the screw for the corresponding input. Using a 22-24 gauge wire strip about 10mm from its end. Push the wire into the hole of the PCV until it stops and then tighten the screw. Make sure to reinstall the rubber plug.

NOTE: If you tin the wires with solder it will make inserting them easier.

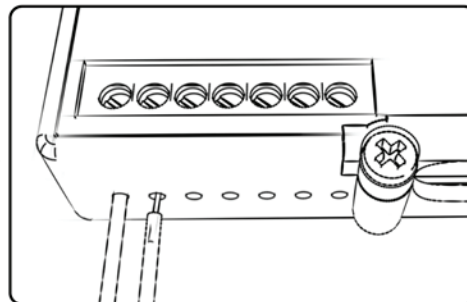

ACCESSORY INPUTS

Map -

(Input 1 or 2) The PCV has the ability to hold 2 different base maps. You can switch on the fly between these two base maps when you hook up a switch to the MAP inputs. You can use any open/close type switch. The polarity of the wires is not important. When using the Autotune kit one position will hold a base map and the other position will let you activate the learning mode. When the switch is "CLOSED" Autotune will be activated. (Set to Switch Input #1 by default.)

Shifter-

(Input 1 or 2) These inputs are for use with the Dynojet quickshifter. Insert the wires from the Dynojet quickshifter into the SHIFTER inputs. The polarity of the wires is not important. (Set to Switch Input #2 by default.)

Speed-

If your application has a speed sensor then you can tap into the signal side of the sensor and run a wire into this input. This will allow you to calculate gear position in the Control Center Software. Once gear position is setup you can alter your map based on gear position and setup gear dependent kill times when using a quickshifter.

Analog-

This input is for a 0-5v signal such as engine temp, boost, etc. Once this input is established you can alter your fuel curve based on this input in the control center software.

Crank-

Do **NOT** connect anything to this port unless instructed to do so by Dynojet. It is used to transfer crank trigger data from one module to another.



- 1 Remove the radiator side panels and remove the fuel tank.
- 2 Secure the PCV to the left side of the frame spar using the supplied Velcro (Fig. A).

Make sure to clean both surfaces with the alcohol swab before attaching.

- 3 Route the PCV harness to the inside of the frame.

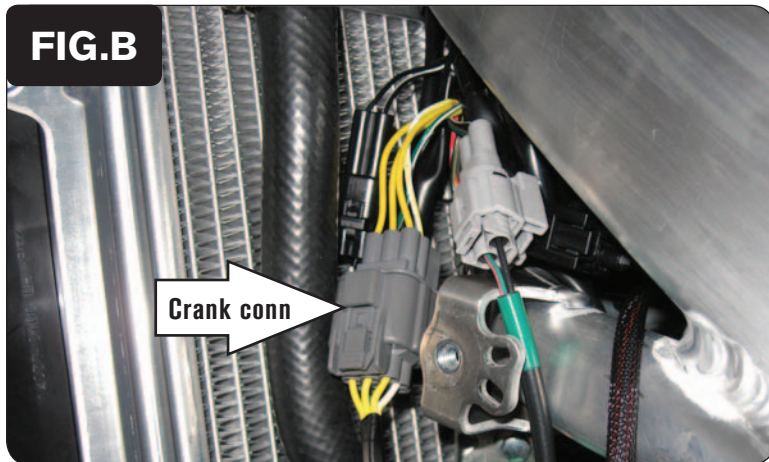

- 4 Locate the GREY 6-pin connector near the left hand side radiator (Fig. B).
- 5 Unplug this connector.

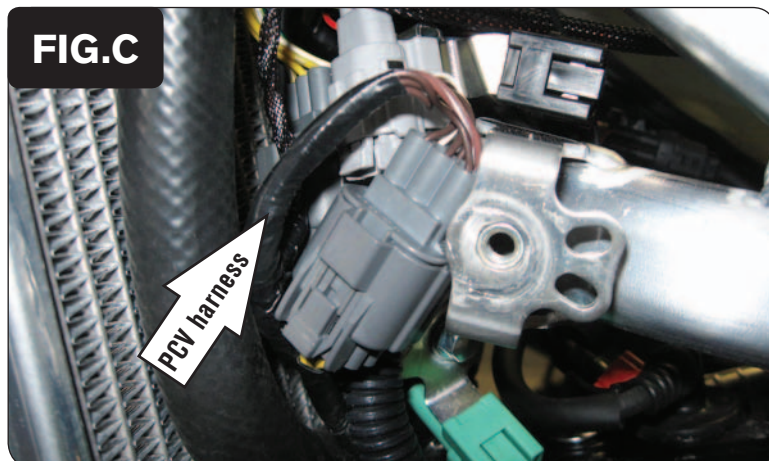

- 6 Plug the pair of 6-pin connectors from the PCV in-line of the stock wiring harness and crank connectors (Fig. C).

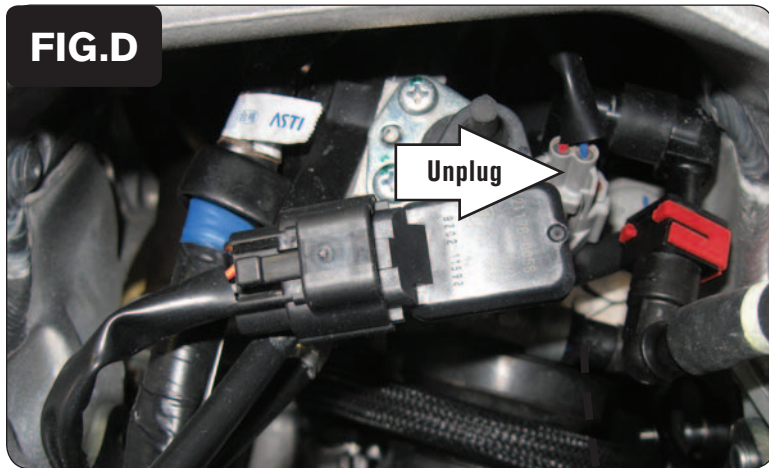

7 Unplug the stock wiring harness from the primary injector (Fig. D).

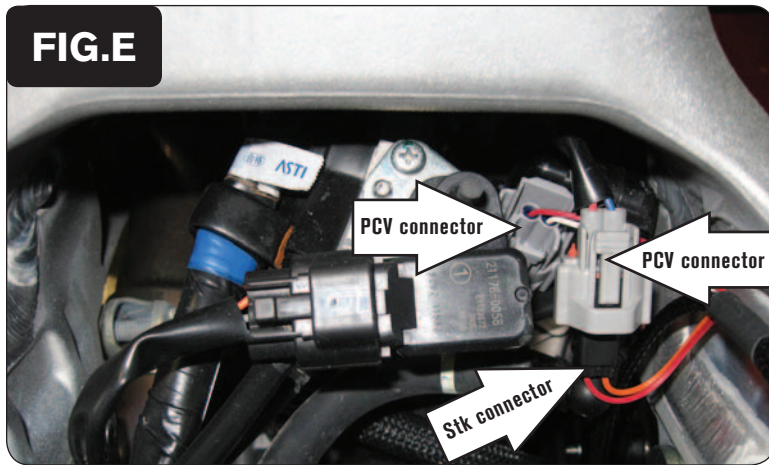

8 Plug the PCV connectors with ORANGE colored wires in-line of the stock wiring harness and primary fuel injector (Fig. E).

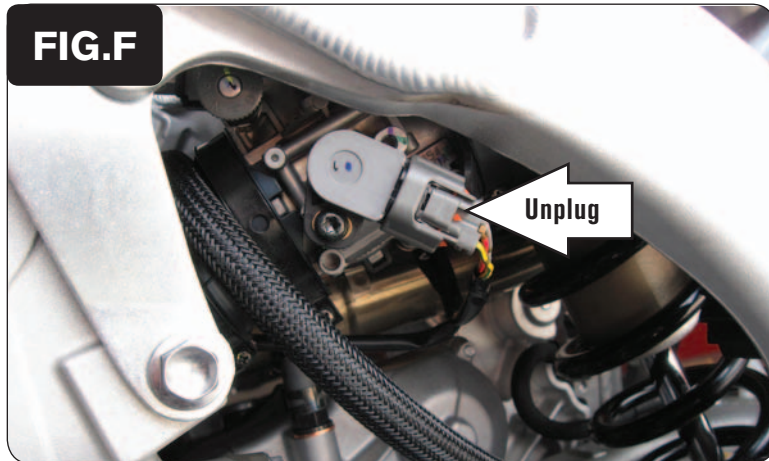

9 Unplug the stock wiring harness from the Throttle Position Sensor (Fig. F).
This connector is located on the left side of the throttle body.

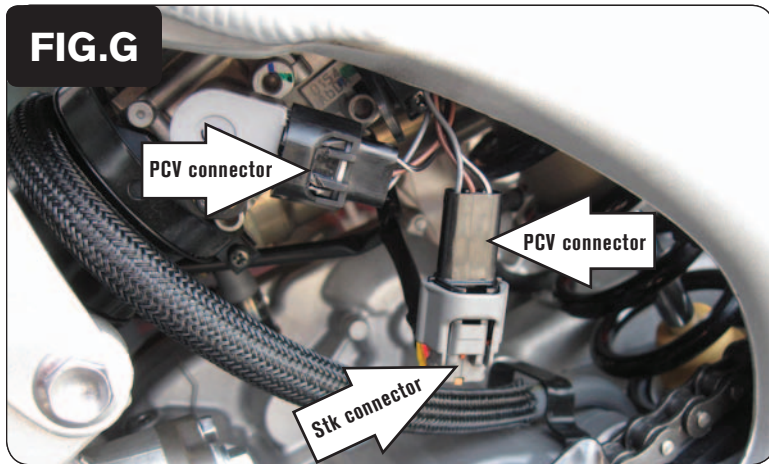

- 10 Plug the PCV connectors in-line of the stock wiring harness and the Throttle Position Sensor (Fig. G).

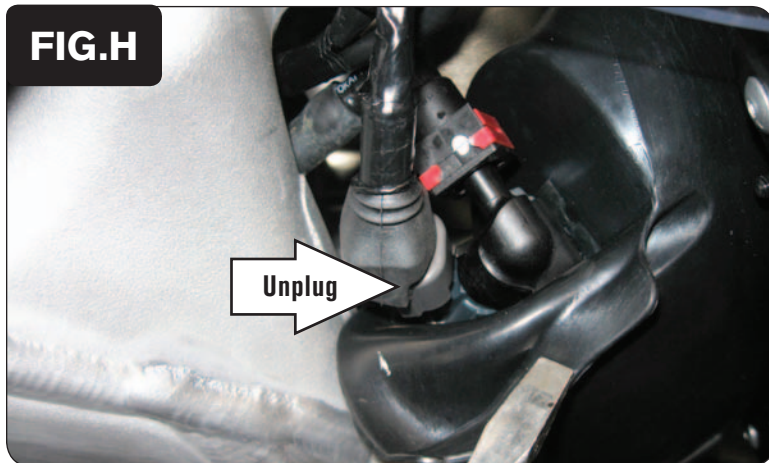

- 11 Locate the secondary fuel injector in the intake duct, behind the rubber flap, on the left side of the bike, to the rear of the frame rail (Fig. H).

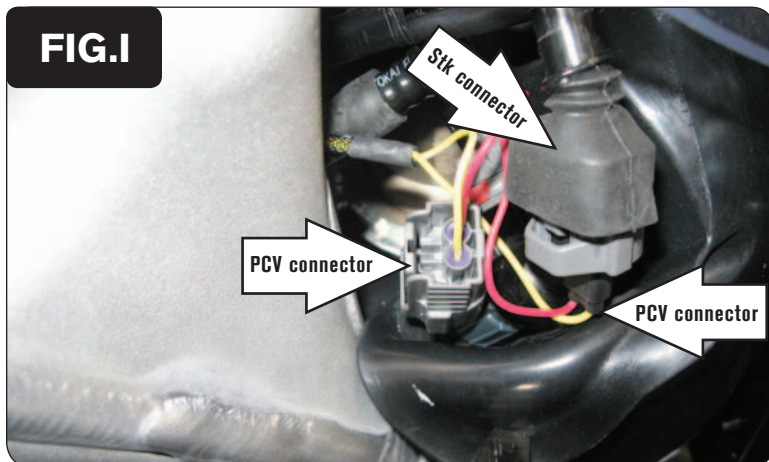

- 12 Plug the PCV connectors with the YELLOW colored wires in-line of the stock wiring harness and the secondary fuel injector (Fig. I).

FIG.J

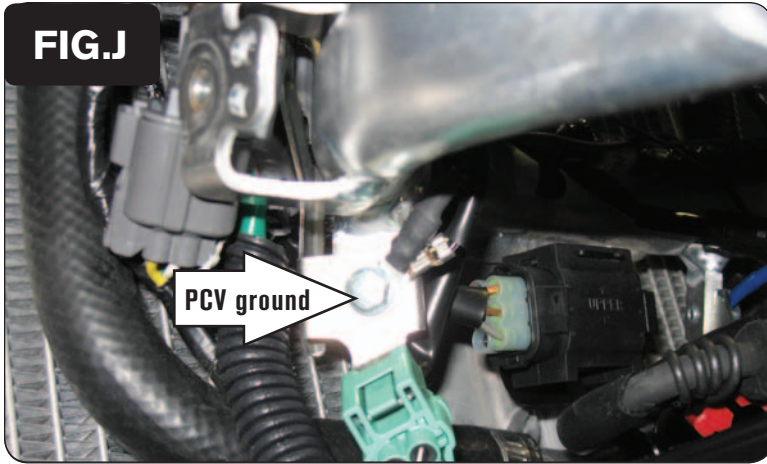

- 13 Attach the ground wire of the PCV to the stock ground location (Fig. J).
This is located near the crank connector you plugged into in step 6.
- 14 Reinstall the fuel tank making sure it does not interfere with the PCV harness.
- 15 Reinstall side panels and seat.