

[POWER COMMANDER V]

FUEL AND IGNITION

2008-2011 Kawasaki Brute Force 750

Installation Instructions



PARTS LIST

- 1 Power Commander
- 1 USB Cable
- 1 Installation Guide
- 2 Power Commander Decals
- 2 Dynojet Decals
- 2 Velcro strips
- 1 Alcohol swab
- 3 Zip-ties

THE IGNITION MUST BE TURNED OFF BEFORE INSTALLATION!

THE LATEST POWER COMMANDER SOFTWARE AND MAP FILES CAN BE DOWNLOADED FROM OUR WEB SITE AT:
www.powercommander.com

PLEASE READ ALL DIRECTIONS BEFORE STARTING INSTALLATION

Dynojet

2191 Mendenhall Drive North Las Vegas, NV 89081 (800) 992-4993 www.powercommander.com

POWER COMMANDER V INPUT ACCESSORY GUIDE

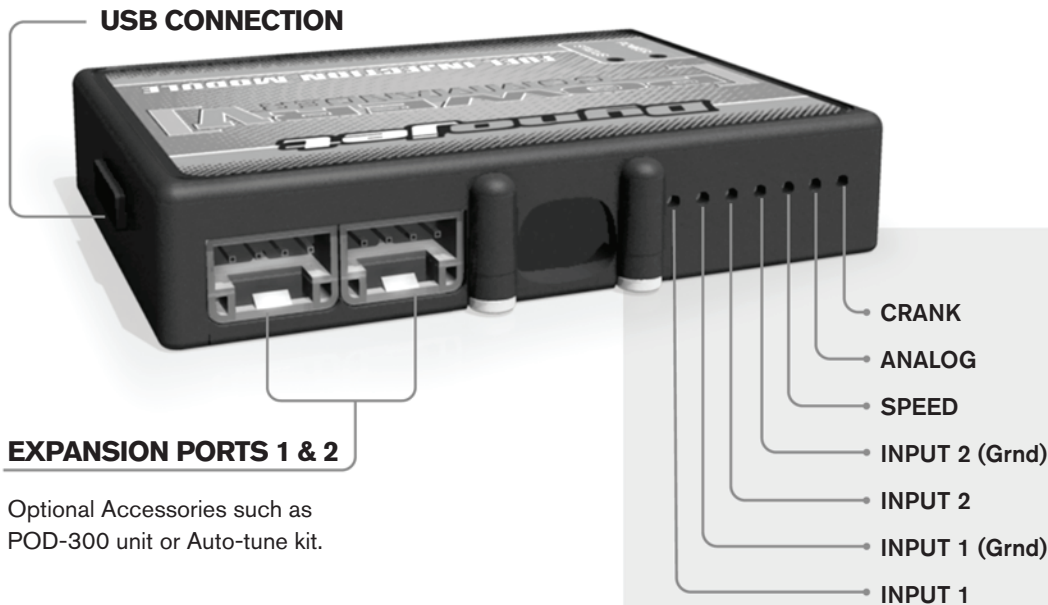

Wire connections:

To input wires into the PCV first remove the rubber plug on the backside of the unit and loosen the screw for the corresponding input. Using a 22-24 gauge wire strip about 10mm from its end. Push the wire into the hole of the PCV until it stops and then tighten the screw. Make sure to reinstall the rubber plug.

NOTE: If you tin the wires with solder it will make inserting them easier.

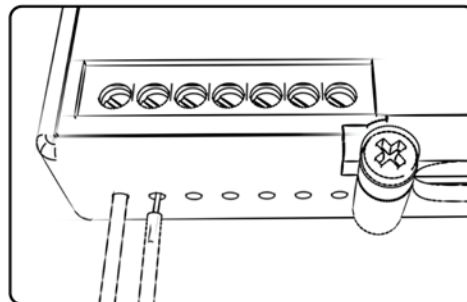

ACCESSORY INPUTS

Map -

(Input 1 or 2) The PCV has the ability to hold 2 different base maps. You can switch on the fly between these two base maps when you hook up a switch to the MAP inputs. You can use any open/close type switch. The polarity of the wires is not important. When using the Autotune kit one position will hold a base map and the other position will let you activate the learning mode. When the switch is "CLOSED" Autotune will be activated. (Set to Switch Input #1 by default.)

Shifter-

(Input 1 or 2) These inputs are for use with the Dynojet quickshifter. Insert the wires from the Dynojet quickshifter into the SHIFTER inputs. The polarity of the wires is not important. (Set to Switch Input #2 by default.)

Speed-

If your application has a speed sensor then you can tap into the signal side of the sensor and run a wire into this input. This will allow you to calculate gear position in the Control Center Software. Once gear position is setup you can alter your map based on gear position and setup gear dependent kill times when using a quickshifter.

Analog-

This input is for a 0-5v signal such as engine temp, boost, etc. Once this input is established you can alter your fuel curve based on this input in the control center software.

Crank-

Do **NOT** connect anything to this port unless instructed to do so by Dynojet. It is used to transfer crank trigger data from one module to another.



- 1 Remove the seat. Remove the right hand side cover, and the cover in front of the steering stem that holds the accessory outlet (Fig. A).

The shifter knob and key switch will need to be removed to pull the right side cover off.

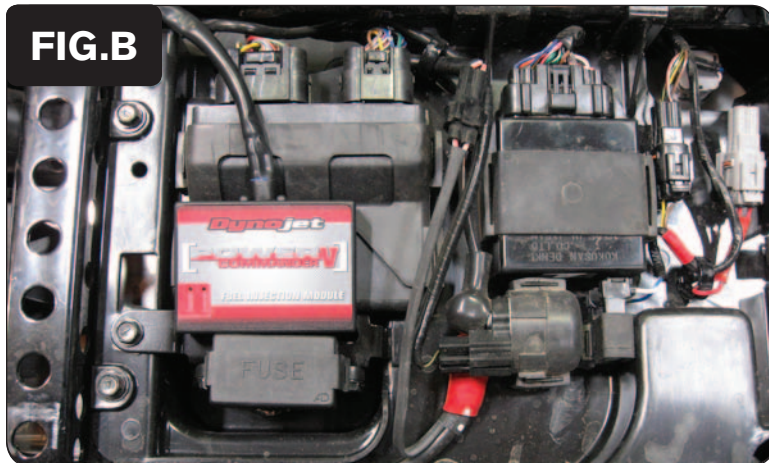

- 2 Attach the PCV module to the top of the ECM under the seat in the location shown in Fig. B.

Use the supplied alcohol swap to clean the surface area, prior to making the attachment with the supplied velcro.

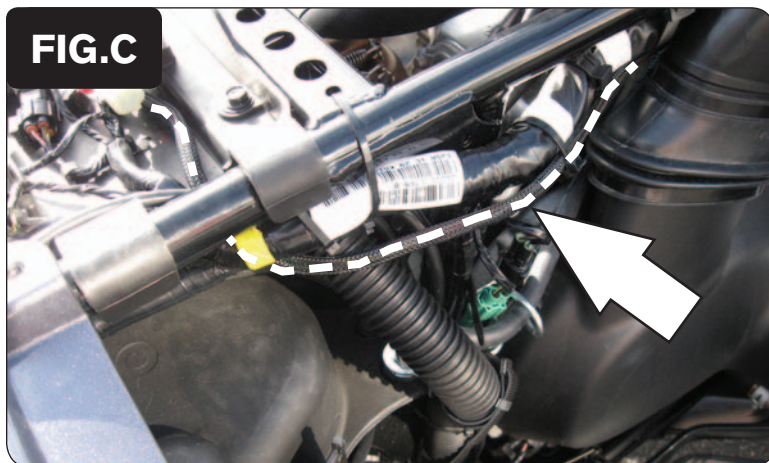

- 3 Route the PCV wire harness under the plastic tray and down the right hand side of the ATV, following the stock wiring harness (Fig. C).

This wire routing will be much easier with the clutch snorkel and the 2 bolts at the front of the tray under the seat removed.

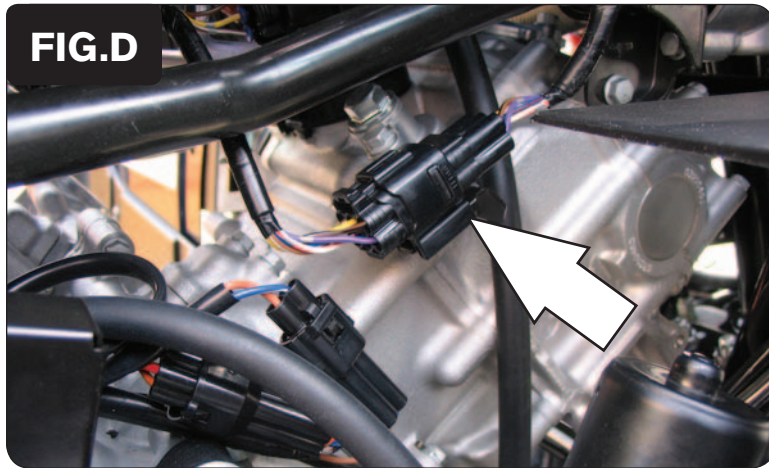

- 4 Locate the 6-pin BLACK connector that comes from the throttle bodies. Unplug this connector (Fig. D).



- 5 Connect the PCV wiring harness in-line with the stock wiring harness and throttle body harness (Fig. E).

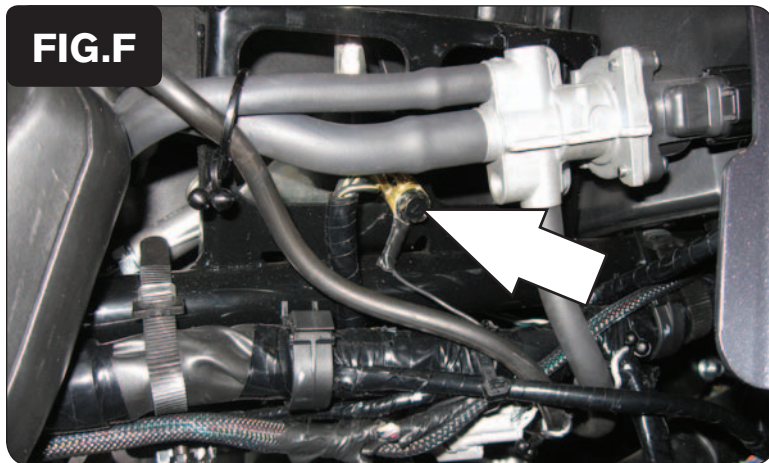

- 6 Secure the ground wire of the Power Commander harness to the ground bolt on the shifter bracket (Fig. F).

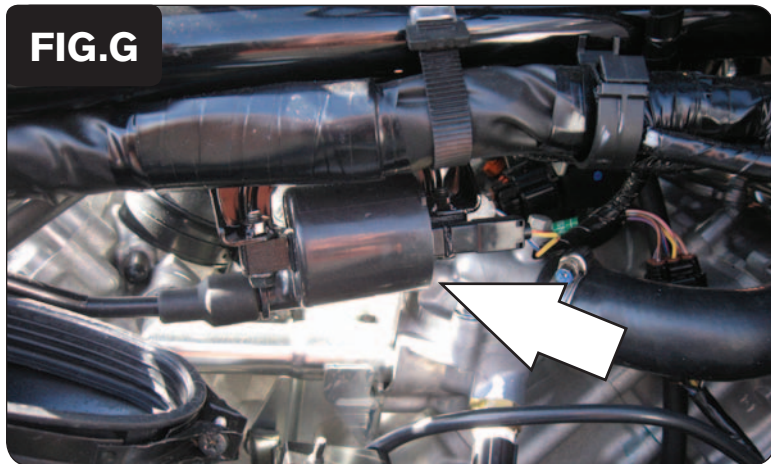

- 7 Locate the rear ignition coil. It is located on the right hand side of the ATV near the frame rail (Fig. G).

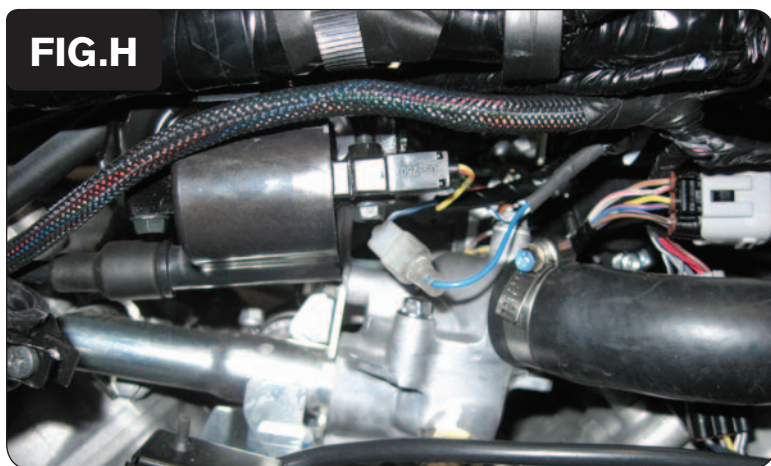

- 8 Unplug the BLUE/WHITE wire on the ATV's rear ignition coil.
- 9 Connect the set of BLUE colored wires of the PCV harness, in-line of the stock coil and the BLUE/WHITE wire (Fig. H).

The BLUE/WHITE wire is the one closer to the engine.

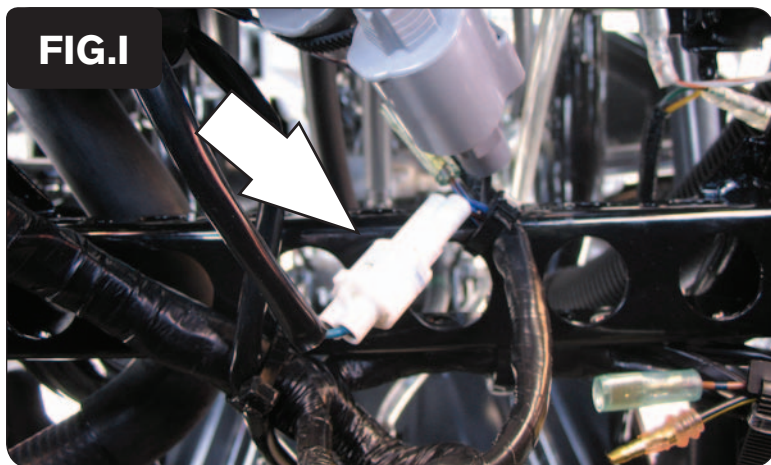

- 10 Continue to route the remainder of the PCV wiring harness down the frame rail and up to where the crank position sensor connectors are located.

These connectors are located behind the steering stem cover that was removed in step 1.

They are WHITE, 2-pin connectors, and are located by the steering stem (Fig. I).

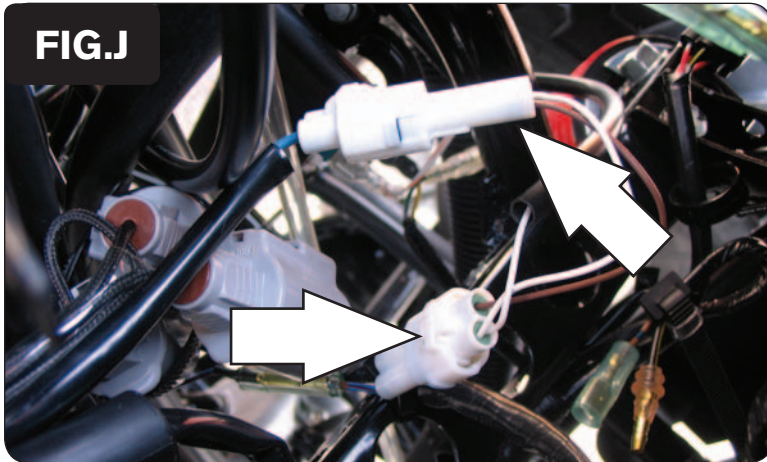

- 11 Plug the set of WHITE 2-pin connectors of the PCV harness in line with the ATV's crank position sensor connectors (Fig. J).

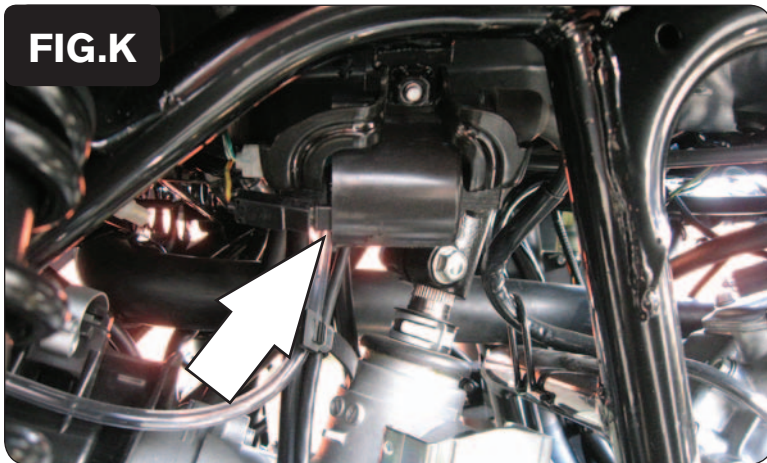

- 12 Continue to route the remainder of the PCV wiring harness downward by the steering stem and to the left, where the front ignition coil is located (Fig. K).
- 13 Unplug the YELLOW/RED wire on the front ignition coil.
- 14 Connect the set of RED wires of the PCV harness in-line with the coil and the YELLOW/RED wire.

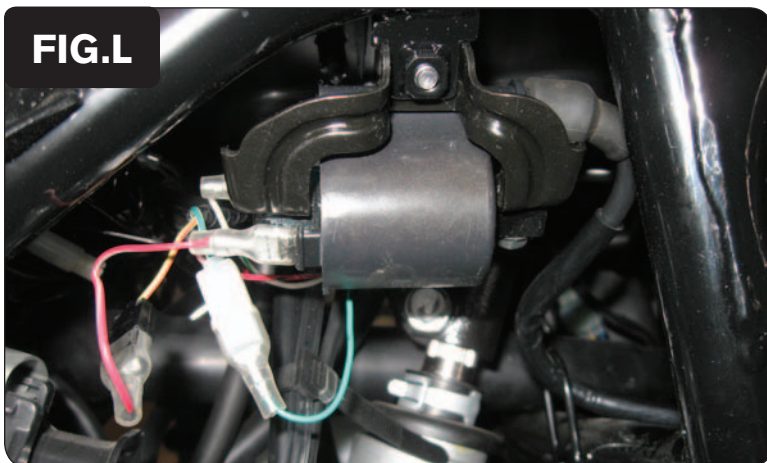

- 15 Unplug the GREEN/WHITE wire on the front ignition coil.
- 16 Connect the set of GREEN wires of the PCV harness in-line with the coil and the GREEN/WHITE wire (Fig. L).
The GREEN/WHITE wire is the one closer to the steering stem.
- 17 Use the supplied zip ties to tie up the PCV harness, being sure to keep it free and clear of any hot or moving parts.
- 18 Reinstall the clutch snorkel (if removed), plastic covers, shifter knob, key switch, and seat.