

[POWER COMMANDER V]

FUEL AND IGNITION

2009-2014 Kawasaki VN1700 Models

CLASSIC - VOYAGER - NOMAD - VAQUERO

Installation Instructions



PARTS LIST

- 1 Power Commander
- 1 USB Cable
- 1 Installation Guide
- 2 Power Commander Decals
- 2 Dynojet Decals
- 2 Velcro strips
- 1 Alcohol swab
- 3 Posi-taps

THE IGNITION MUST BE TURNED OFF BEFORE INSTALLATION!

THE LATEST POWER COMMANDER SOFTWARE AND MAP FILES CAN BE DOWNLOADED FROM OUR WEB SITE AT:
www.powercommander.com

PLEASE READ ALL DIRECTIONS BEFORE STARTING INSTALLATION

Dynojet

2191 Mendenhall Drive North Las Vegas, NV 89081 (800) 992-4993 www.powercommander.com

POWER COMMANDER V INPUT ACCESSORY GUIDE

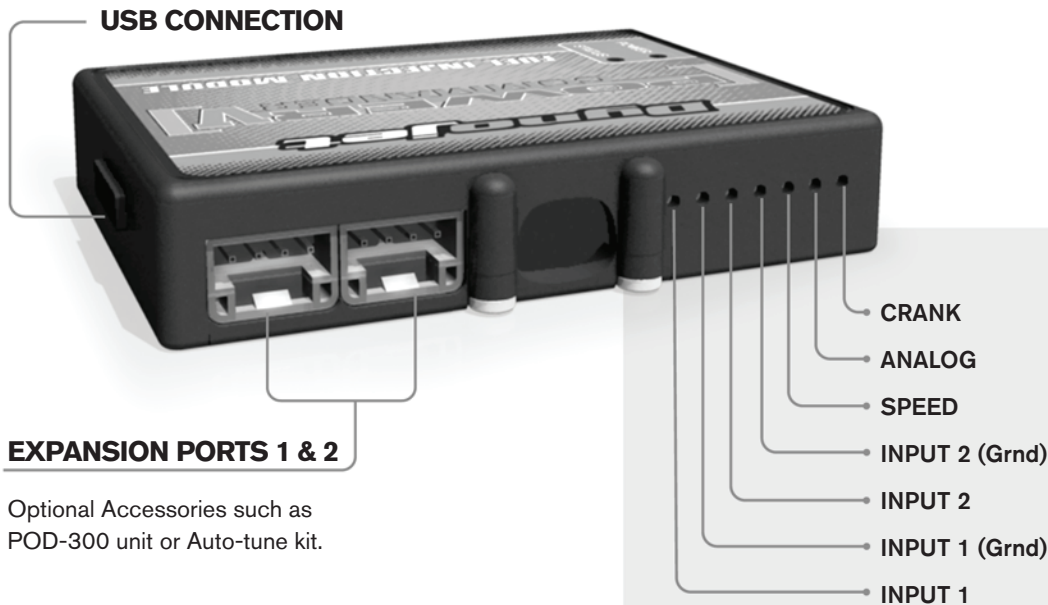

Wire connections:

To input wires into the PCV first remove the rubber plug on the backside of the unit and loosen the screw for the corresponding input. Using a 22-24 gauge wire strip about 10mm from its end. Push the wire into the hole of the PCV until it stops and then tighten the screw. Make sure to reinstall the rubber plug.

NOTE: If you tin the wires with solder it will make inserting them easier.

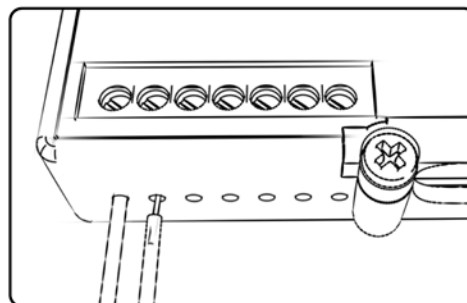

ACCESSORY INPUTS

Map -

(Input 1 or 2) The PCV has the ability to hold 2 different base maps. You can switch on the fly between these two base maps when you hook up a switch to the MAP inputs. You can use any open/close type switch. The polarity of the wires is not important. When using the Autotune kit one position will hold a base map and the other position will let you activate the learning mode. When the switch is "CLOSED" Autotune will be activated. (Set to Switch Input #1 by default.)

Shifter-

(Input 1 or 2) These inputs are for use with the Dynojet quickshifter. Insert the wires from the Dynojet quickshifter into the SHIFTER inputs. The polarity of the wires is not important. (Set to Switch Input #2 by default.)

Speed-

If your application has a speed sensor then you can tap into the signal side of the sensor and run a wire into this input. This will allow you to calculate gear position in the Control Center Software. Once gear position is setup you can alter your map based on gear position and setup gear dependent kill times when using a quickshifter.

Analog-

This input is for a 0-5v signal such as engine temp, boost, etc. Once this input is established you can alter your fuel curve based on this input in the control center software.

Crank-

Do **NOT** connect anything to this port unless instructed to do so by Dynojet. It is used to transfer crank trigger data from one module to another.

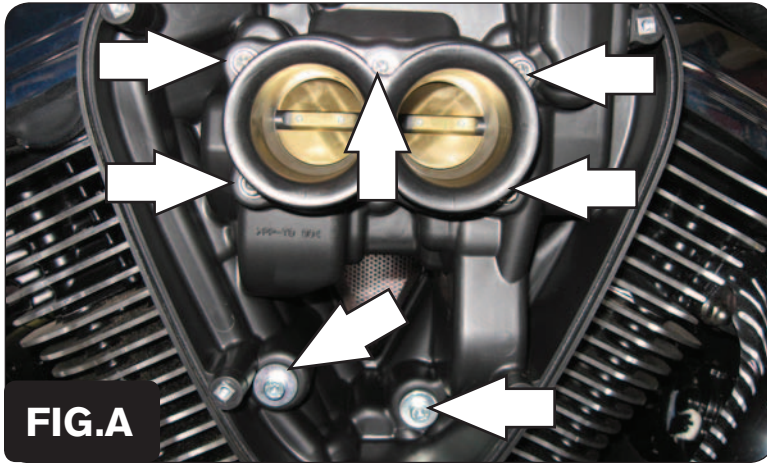

- 1 Remove the seats.
- 2 Remove the chrome airbox cover on the right side of the bike
- 3 Remove the airbox by removing the 7 allen bolts.

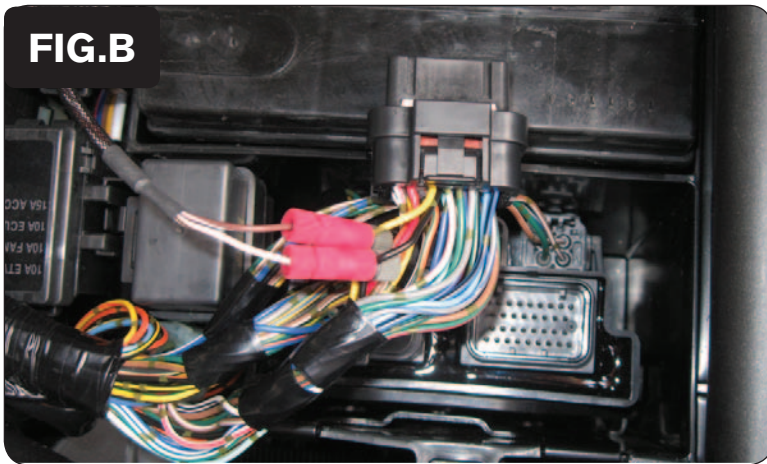

- 4 Remove the battery cover and locate the stock ECU.
- 5 Using the supplied posi-taps attach the PCV harness to the stock wiring harness as in Figure B.
PCV BROWN/WHITE to stock YELLOW
PCV WHITE/BROWN to stock BLACK

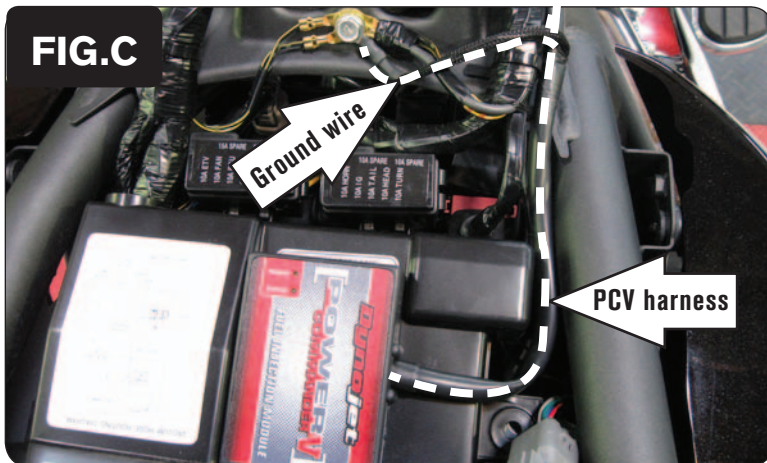
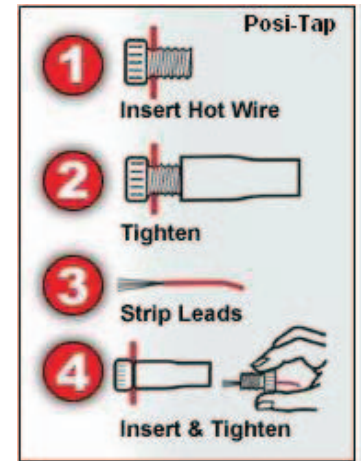

- 6 Secure the PCV to the top of the battery cover using the supplied velcro
Use the alcohol swab to clean both surfaces before attaching.
- 7 Route the PCV harness down the right side of the bike (Fig. C).
- 8 Attach the ground wire of the PCV to the ground junction in front of the fuse box assembly (Fig. C).



- 9 Route the PCV harness along the main wiring harness (Fig. D).

Figure C was taken with the tank off. The fuel tank does NOT need to be completely removed to perform this installation; but it may help.

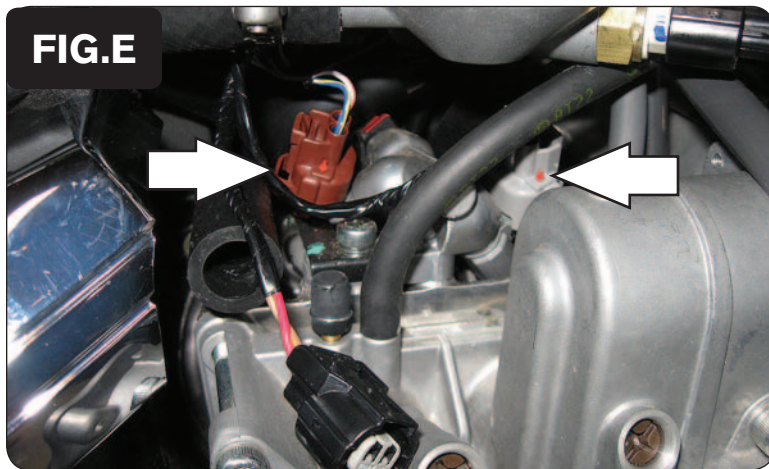

- 10 Unplug the stock wiring harness from each one of the injectors (Fig. E).

Take note of the orientation of these connectors. The BROWN connector goes to the rear injector.



- 11 Plug the PCV harness in-line of the stock wiring harness and each injector (Fig. F)

PCV harness:

ORANGE wires go to the front injector (GREY)

YELLOW wires go to the rear injector (BROWN)

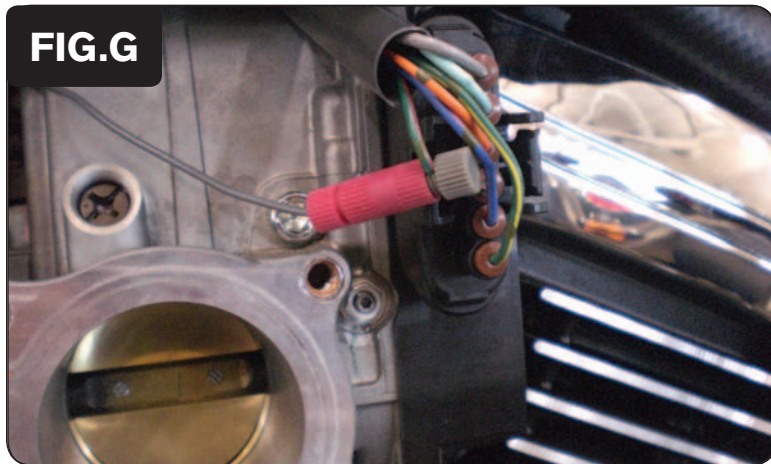

FIG.G

- 12 Attach the GREY wire of the PCV to the stock GREEN/RED wire of the Throttle Body Servo connector (Fig. G).

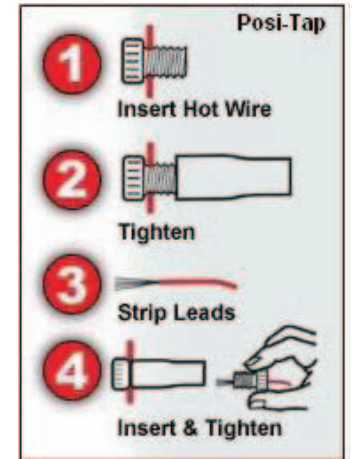

FIG.H

- 13 Plug the PCV harness in-line of the stock wiring harness and the right hand ignition coil (Fig. H)

PCV harness:

RED wires go to RED/GREEN wires of coil

GREEN wires go to BLACK wires of coil

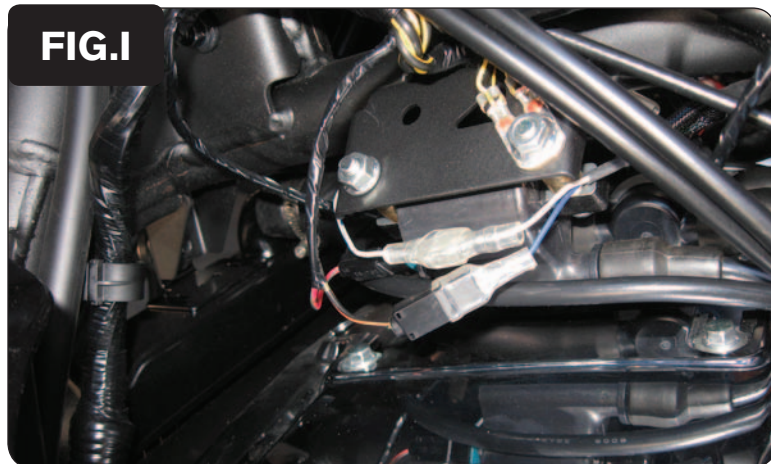

FIG.I

- 14 Plug the PCV harness in-line of the stock wiring harness and the left hand ignition coil (Fig. I)

PCV harness:

BLUE wires go to BLACK/ORANGE wires of coil.

- 15 Reinstall airbox and seats.