

# [POWER COMMANDER V]

**2017 Kawasaki Z900**

**Installation Instructions**



## **PARTS LIST**

- 1 Power Commander
- 1 USB Cable
- 1 Installation Guide
- 2 Power Commander Decals
- 2 Dynojet Decals
- 2 Velcro strips
- 1 Alcohol swab

**THE IGNITION MUST BE TURNED  
OFF BEFORE INSTALLATION!**

THE LATEST POWER COMMANDER  
SOFTWARE AND MAP FILES CAN BE  
DOWNLOADED FROM OUR WEB SITE AT:  
[www.powercommander.com](http://www.powercommander.com)

**PLEASE READ ALL DIRECTIONS BEFORE STARTING INSTALLATION**

**Dynojet**

2191 Mendenhall Drive North Las Vegas, NV 89081 (800) 992-4993 [www.powercommander.com](http://www.powercommander.com)

# POWER COMMANDER V INPUT ACCESSORY GUIDE

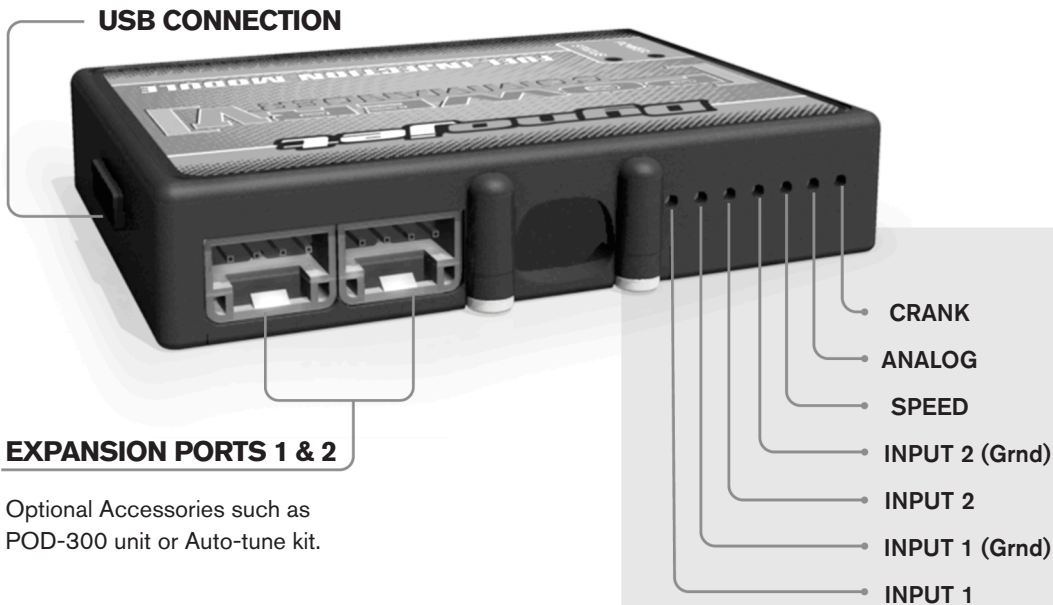

## Wire connections:

To input wires into the PCV first remove the rubber plug on the backside of the unit and loosen the screw for the corresponding input. Using a 22-24 gauge wire strip about 10mm from its end. Push the wire into the hole of the PCV until it stops and then tighten the screw. Make sure to reinstall the rubber plug.

NOTE: If you tin the wires with solder it will make inserting them easier.

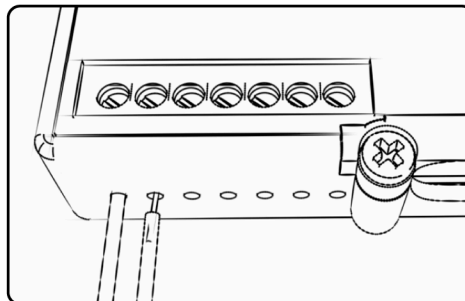

## ACCESSORY INPUTS

### Map -

(Input 1 or 2) The PCV has the ability to hold 2 different base maps. You can switch on the fly between these two base maps when you hook up a switch to the MAP inputs. You can use any open/close type switch. The polarity of the wires is not important. When using the Autotune kit one position will hold a base map and the other position will let you activate the learning mode. When the switch is "CLOSED" Autotune will be activated. (Set to Switch Input #1 by default.)

### Shifter-

(Input 1 or 2) These inputs are for use with the Dynojet quickshifter. Insert the wires from the Dynojet quickshifter into the SHIFTER inputs. The polarity of the wires is not important. (Set to Switch Input #2 by default.)

### Speed-

If your application has a speed sensor then you can tap into the signal side of the sensor and run a wire into this input. This will allow you to calculate gear position in the Control Center Software. Once gear position is setup you can alter your map based on gear position and setup gear dependent kill times when using a quickshifter.

### Analog-

This input is for a 0-5v signal such as engine temp, boost, etc. Once this input is established you can alter your fuel curve based on this input in the control center software.

### Crank-

Do **NOT** connect anything to this port unless instructed to do so by Dynojet. It is used to transfer crank trigger data from one module to another.

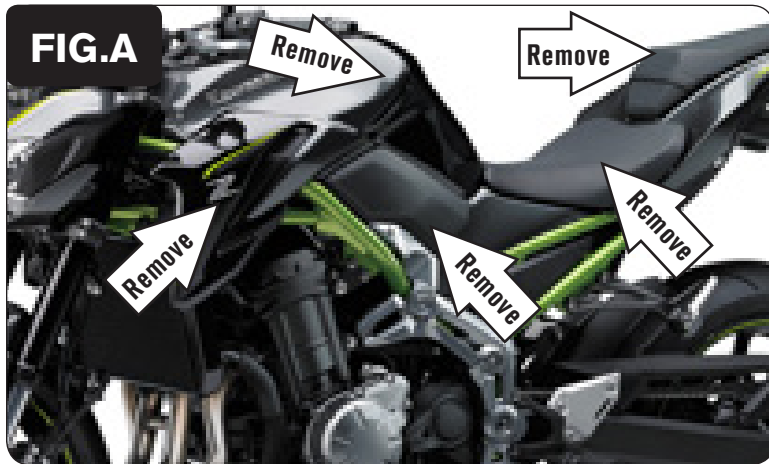

- 1 Remove the seats, the right and left side body panels below and forward of the seat, and the fuel tank cover (Fig. A).
- 2 Remove the fuel tank and the air box.

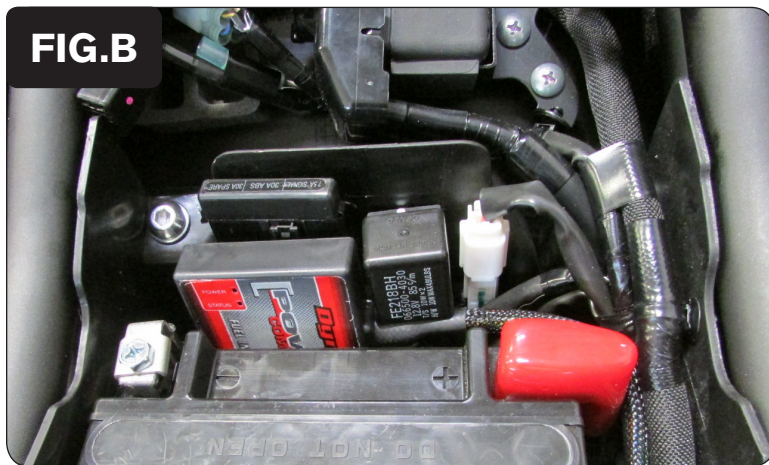

- 3 Secure the PCV module under the seat and next to the battery (Fig. B).
- 4 Route the PCV wiring harness forward towards the engine following inside the left frame rail.

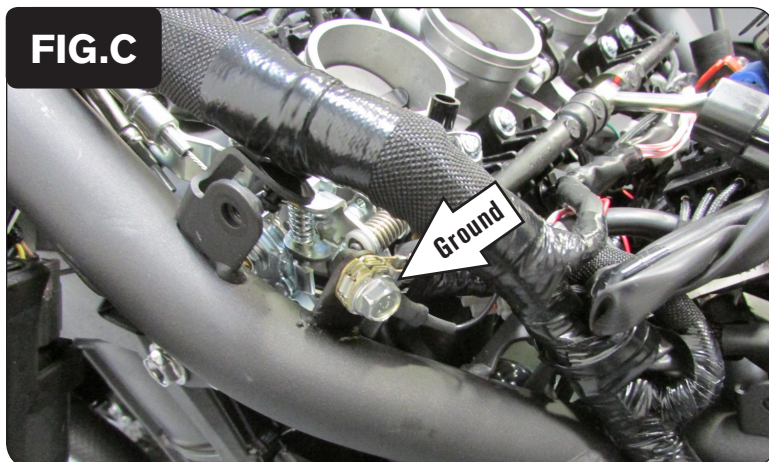

- 5 Secure the PCV ground wire with the small ring lug to the common ground location on the left side of the frame (Fig. C).

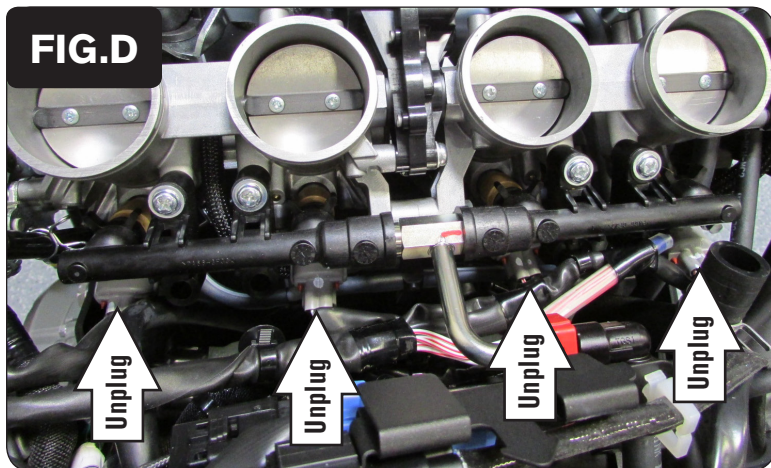

6 Unplug all four of the bike's Fuel Injectors (Fig. D).

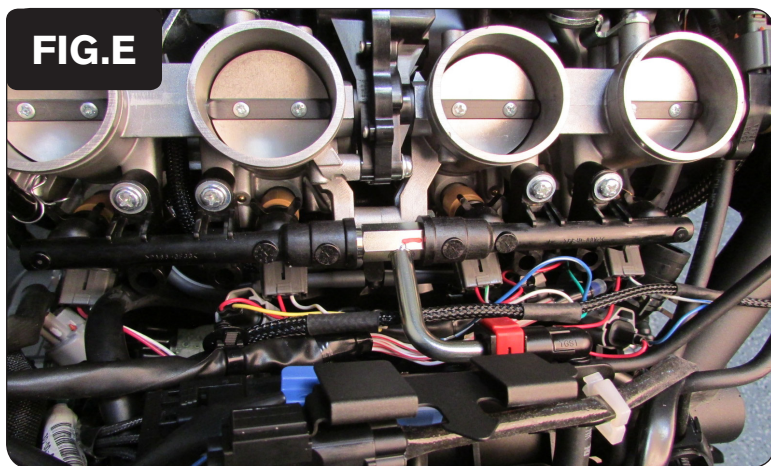

7 Plug the PCV wiring harness in-line of each injector and the stock wiring harness (Fig. E).

*The pair of PCV leads with ORANGE colored wires go in-line of the Cylinder #1 (left most) injector.*

*The pair of PCV leads with YELLOW colored wires go in-line of the Cylinder #2 injector.*

*The pair of PCV leads with GREEN colored wires go in-line of the Cylinder #3 injector.*

*The pair of PCV leads with BLUE colored wires go in-line of the Cylinder #4 (right most) injector.*



8 Route the pair of 3-pin connectors on the PCV wiring harness towards the right side of the throttle bodies.

9 Locate and unplug the Primary Throttle Position Sensor (Fig. F).

*This sensor is located on the right side of the throttle bodies.*

*This is the LOWER PRIMARY Throttle Position Sensor with the BLACK connector.*

*Do NOT plug the PCV into the UPPER SECONDARY Throttle Position Sensor with the GREY connector.*

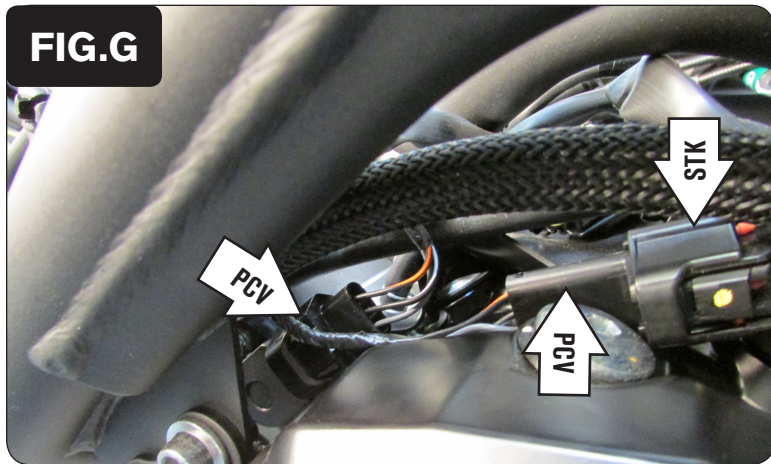

- 10 Plug the pair of 3-pin connectors on the PCV wiring harness in-line of the Lower Primary Throttle Position Sensor and the stock wiring harness (Fig. G).
- 11 Reinstall the airbox, fuel tank, body work, and seats.

**Optional inputs:**

**Gear** - GREEN/RED wire of sensor on left side of engine near shift shaft

**Engine temp** - GREEN/WHITE wire located on back of cylinder between #3 & #4

**12v source for Auto-tune** - RED wire on tail/tag light connector