

[POWER COMMANDER V]

2011-2012 Husqvarna 630 models

Installation Instructions



PARTS LIST

- 1 Power Commander
- 1 USB Cable
- 1 Installation Guide
- 2 Power Commander Decals
- 2 Dynojet Decals
- 2 Velcro strips
- 1 Alcohol swab
- 1 O2 Optimizer
- 1 Posi-tap

**THE IGNITION MUST BE TURNED
OFF BEFORE INSTALLATION!**

THE LATEST POWER COMMANDER
SOFTWARE AND MAP FILES CAN BE
DOWNLOADED FROM OUR WEB SITE AT:
www.powercommander.com

PLEASE READ ALL DIRECTIONS BEFORE STARTING INSTALLATION

Dynojet

2191 Mendenhall Drive North Las Vegas, NV 89081 (800) 992-4993 www.powercommander.com

POWER COMMANDER V INPUT ACCESSORY GUIDE

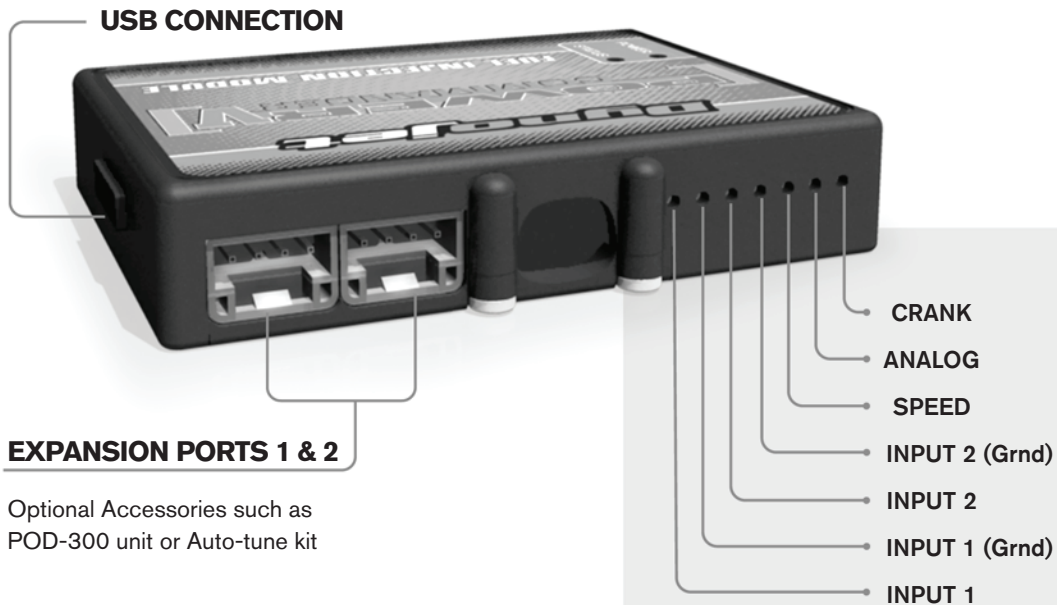

Wire connections:

To input wires into the PCV first remove the rubber plug on the backside of the unit and loosen the screw for the corresponding input. Using a 22-24 gauge wire strip about 10mm from its end. Push the wire into the hole of the PCV until it stops and then tighten the screw. Make sure to reinstall the rubber plug.

NOTE: If you tin the wires with solder it will make inserting them easier.

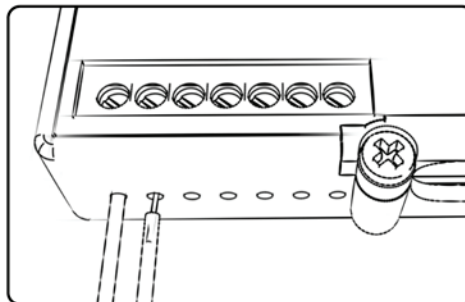

ACCESSORY INPUTS

Map -

(Input 1 or 2) The PCV has the ability to hold 2 different base maps. You can switch on the fly between these two base maps when you hook up a switch to the MAP inputs. You can use any open/close type switch. The polarity of the wires is not important. When using the Autotune kit one position will hold a base map and the other position will let you activate the learning mode. When the switch is "CLOSED" Autotune will be activated. (Set to Switch Input #1 by default.)

Shifter-

(Input 1 or 2) These inputs are for use with the Dynojet quickshifter. Insert the wires from the Dynojet quickshifter into the SHIFTER inputs. The polarity of the wires is not important. (Set to Switch Input #2 by default.)

Speed-

If your application has a speed sensor then you can tap into the signal side of the sensor and run a wire into this input. This will allow you to calculate gear position in the Control Center Software. Once gear position is setup you can alter your map based on gear position and setup gear dependent kill times when using a quickshifter.

Analog-

This input is for a 0-5v signal such as engine temp, boost, etc. Once this input is established you can alter your fuel curve based on this input in the control center software.

Crank-

Do **NOT** connect anything to this port unless instructed to do so by Dynojet. It is used to transfer crank trigger data from one module to another.



FIG.A

- 1 Remove the seat.
- 2 Remove the fuel tank.
- 3 Using the supplied Velcro, attach the PCV module to the inner side of the right hand side cover (Fig. A).

Clean both surfaces with the supplied alcohol swab before attaching the Velcro.

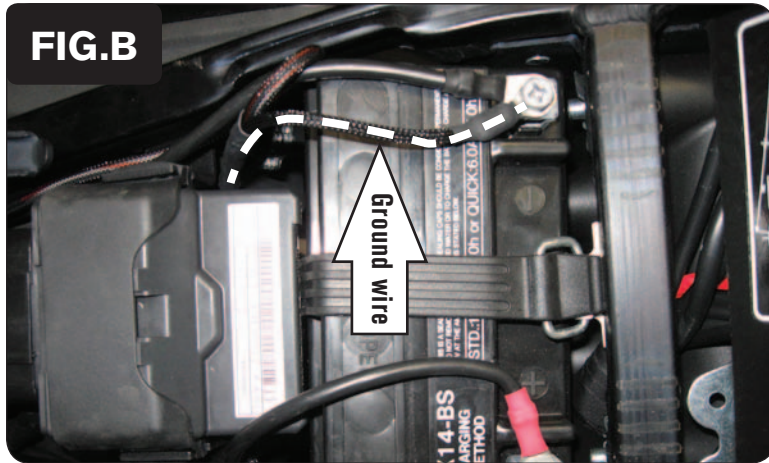

FIG.B

- 4 Attach the PCV ground wire with the small ring lug to the negative (-) terminal of the bike's battery (Fig. B).

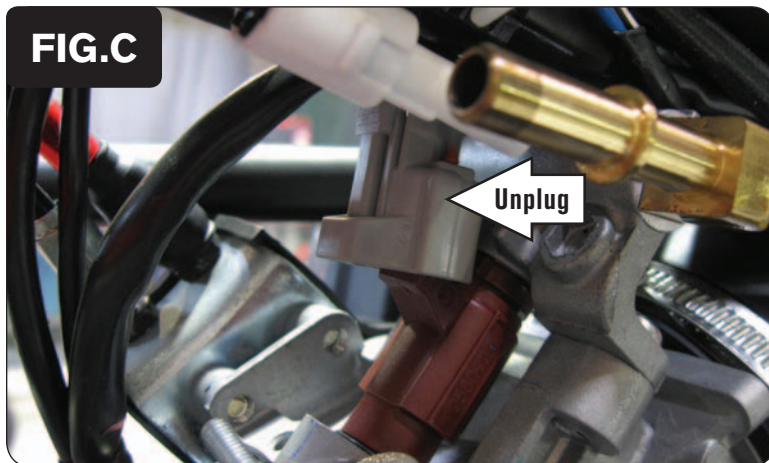
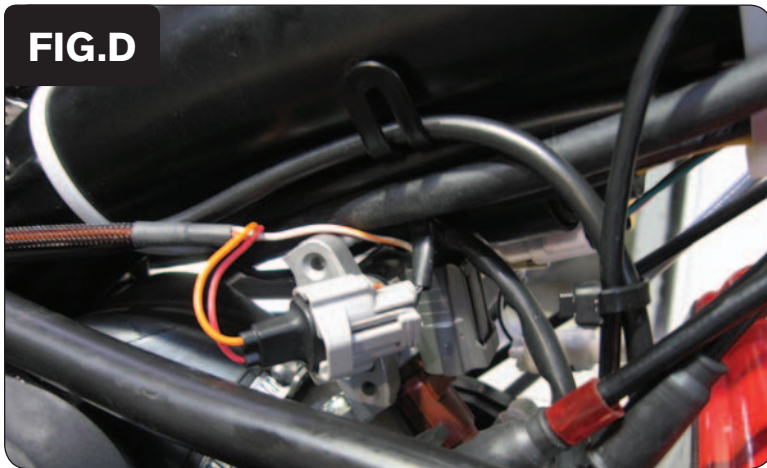
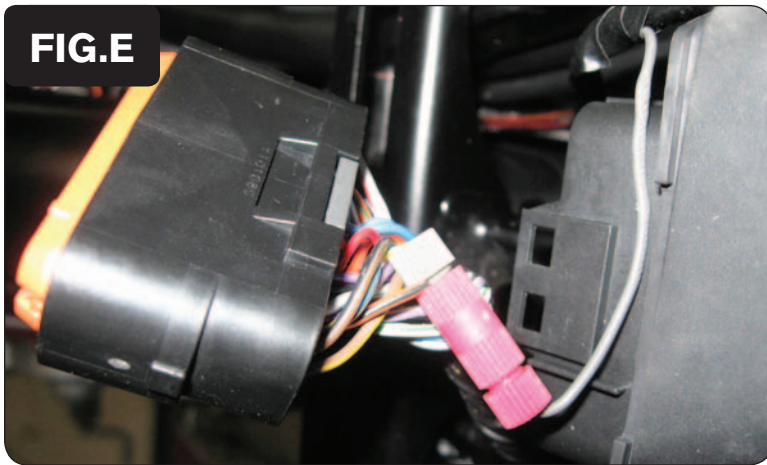

FIG.C

- 5 Route the PCV wiring harness towards the throttle body, going underneath the frame support.
- 6 Unplug the stock wiring harness from the fuel injector (Fig. C).



- 7 Plug the PCV wiring harness in-line of the fuel injector and the stock wiring harness (Fig. D).



- 8 Using the supplied Posi-tap, attach the GREY wire from the PCV to the stock ORANGE/BLACK wire of the main wiring harness (Fig. E).

This is the 3rd wire from the end, on the top row of the ECU connector.

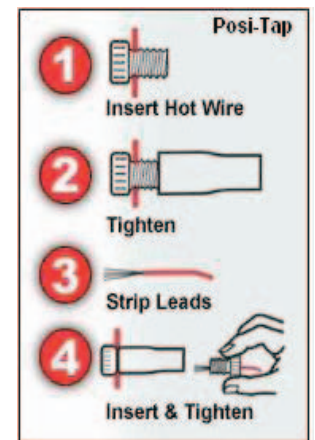

- 9 Locate the stock O2 sensor connection. This is under the fuel tank on the left hand side of the frame (Fig. F).
- 10 Unplug this connection and plug the supplied O2 Optimizer into the stock wiring harness.

The stock O2 sensor will no longer be used. It can be removed from the exhaust if desired and if you have a way to plug the hole in the exhaust.

- 11 Reinstall the fuel tank and the seat.

