

[POWER COMMANDER V]

FUEL AND IGNITION

Can-Am Outlander models *

Installation Instructions



* This unit fits the following models:

2013-2015 Outlander 500

2011-2016 Outlander 650

2016 Outlander 850

2016 Outlander 570

2012-2016 Outlander 800

2012-2016 Outlander 1000

PARTS LIST

- 1 Power Commander
- 1 USB Cable
- 1 Installation Guide
- 2 Power Commander Decals
- 2 Dynojet Decals
- 2 Velcro strips
- 1 Alcohol swab

THE IGNITION MUST BE TURNED OFF BEFORE INSTALLATION!

YOU CAN ALSO DOWNLOAD THE
POWER COMMANDER SOFTWARE AND
LATEST MAPS FROM OUR WEB SITE AT:
www.powercommander.com

PLEASE READ ALL DIRECTIONS BEFORE STARTING INSTALLATION

Dynojet

2191 Mendenhall Drive North Las Vegas, NV 89081 (800) 992-4993 www.powercommander.com

POWER COMMANDER V INPUT ACCESSORY GUIDE

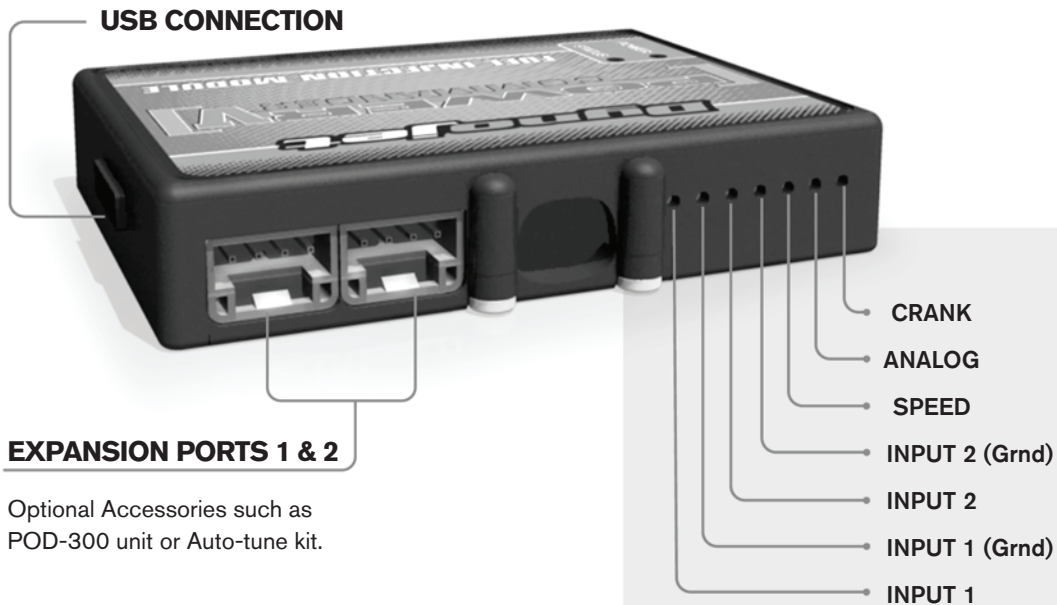

Wire connections:

To input wires into the PCV first remove the rubber plug on the backside of the unit and loosen the screw for the corresponding input. Using a 22-24 gauge wire strip about 10mm from its end. Push the wire into the hole of the PCV until it stops and then tighten the screw. Make sure to reinstall the rubber plug.

NOTE: If you tin the wires with solder it will make inserting them easier.

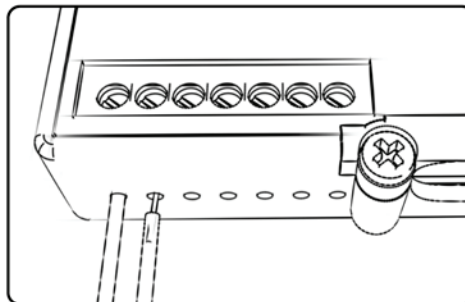

ACCESSORY INPUTS

Map -

(Input 1 or 2) The PCV has the ability to hold 2 different base maps. You can switch on the fly between these two base maps when you hook up a switch to the MAP inputs. You can use any open/close type switch. The polarity of the wires is not important. When using the Autotune kit one position will hold a base map and the other position will let you activate the learning mode. When the switch is "CLOSED" Autotune will be activated. (Set to Switch Input #1 by default.)

Shifter-

(Input 1 or 2) These inputs are for use with the Dynojet quickshifter. Insert the wires from the Dynojet quickshifter into the SHIFTER inputs. The polarity of the wires is not important. (Set to Switch Input #2 by default.)

Speed-

If your application has a speed sensor then you can tap into the signal side of the sensor and run a wire into this input. This will allow you to calculate gear position in the Control Center Software. Once gear position is setup you can alter your map based on gear position and setup gear dependent kill times when using a quickshifter.

Analog-

This input is for a 0-5v signal such as engine temp, boost, etc. Once this input is established you can alter your fuel curve based on this input in the control center software.

Crank-

Do **NOT** connect anything to this port unless instructed to do so by Dynojet. It is used to transfer crank trigger data from one module to another.

Note: These installation steps and pictures are from a 2016 Outlander 570 model. Other models might look slightly different, but similar. This unit also comes preloaded with a map for a stock 2016 Outlander 570. The map will need to be changed from the PCV software for other applications.

1 Remove the seat and right side panel. Also remove the lower right side panel (Fig. A).

2 Remove the splash guard inside the front right fender well (Fig. B).

3 Secure the PCV module to the back side of the airbox as shown in Figure C. Use the supplied Velcro strips to secure the module. Clean both surfaces with the supplied alcohol swab before attaching the Velcro.

4 Route the PCV wiring harness down and to the right, going towards the throttle body.

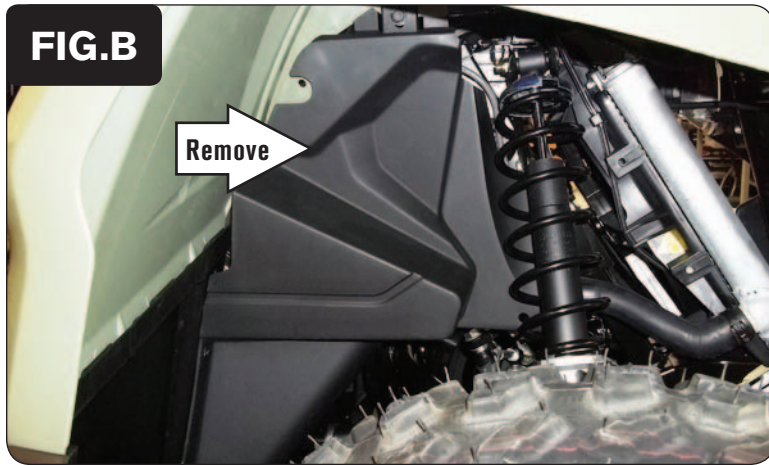

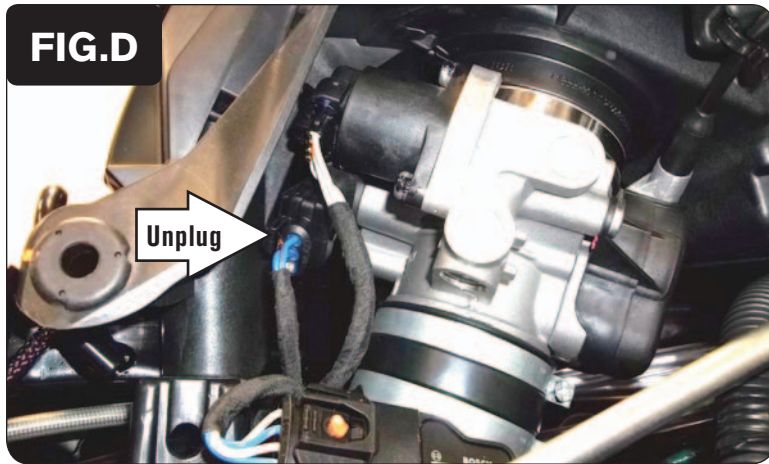

- 5 At the back side of the throttle body, locate and unplug the Throttle Position Sensor (Fig. D).

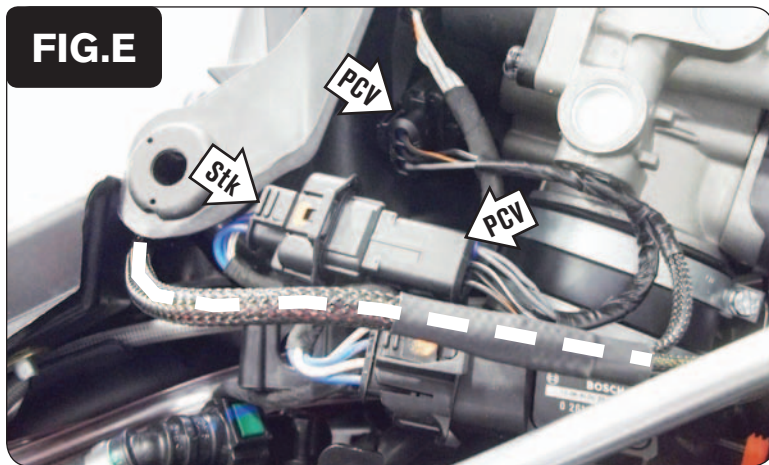

- 6 Plug the pair of 3-pin PCV connectors with GREY wires in-line of the TPS and the stock connector (Fig. E).



- 7 Unplug the rear cylinder fuel injector (Fig. F).

It is difficult to see in this picture; but it is behind the high pressure fuel line and its connector is GREY.

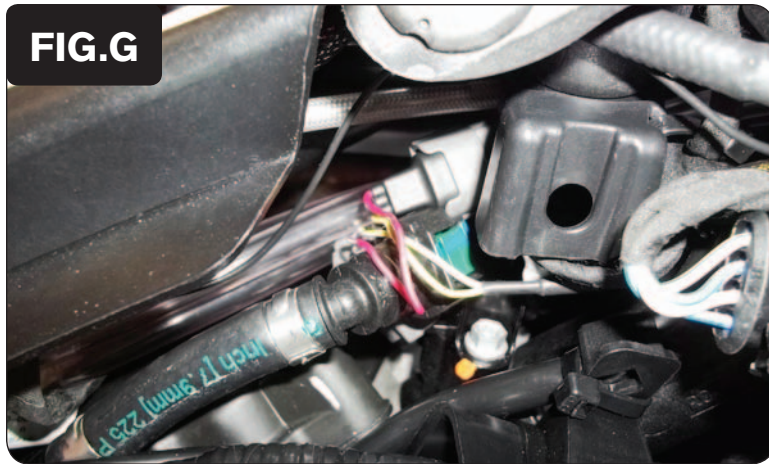

- 8 Plug the pair of PCV 2-pin connectors with YELLOW colored wires in-line of the rear cylinder fuel injector and the stock connector (Fig. G).

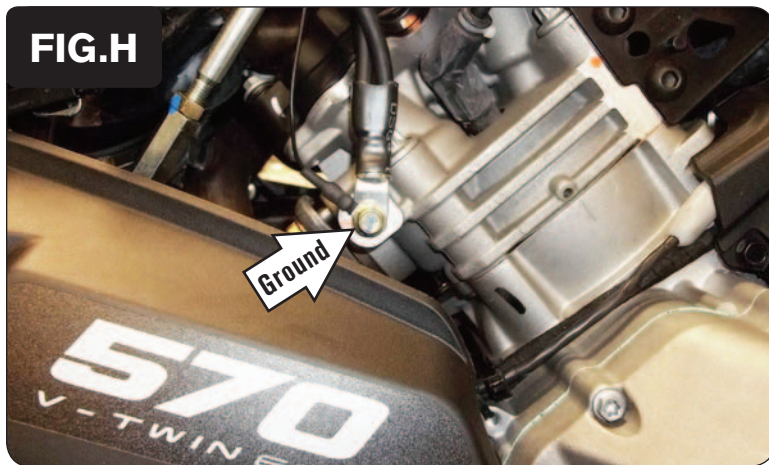

- 9 Route and secure the PCV ground wire with the small ring terminal to the stock common ground bolt on the rear cylinder head (Fig. H).



- 10 Unplug the front cylinder fuel injector (Fig. J).



- 11 Plug the pair of 2-pin PCV connectors with ORANGE colored wires in-line of the front cylinder fuel injector and the stock connector (Fig. K).

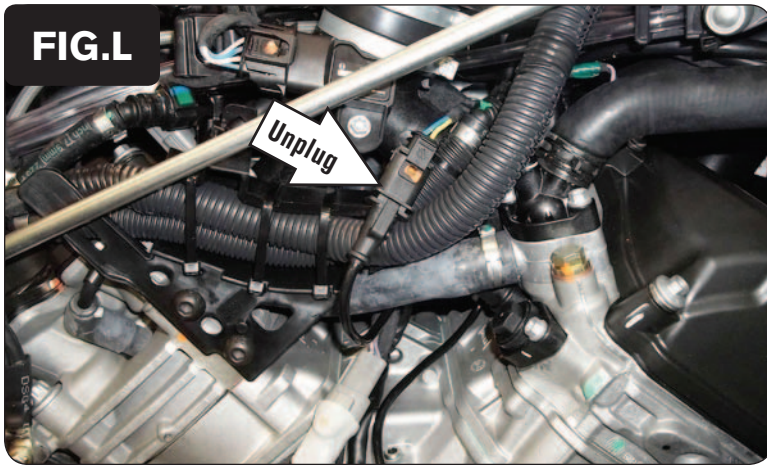

- 12 Locate and unplug the stock Crank Position Sensor connectors (Fig. L).
This is a 2-pin connector pair with a BLUE and a YELLOW wire. They are typically located between the two cylinders at their base.

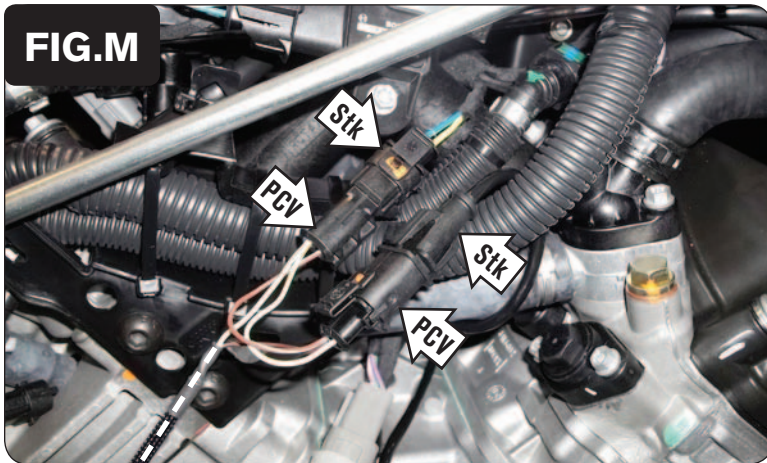

- 13 Plug the pair of 2-pin PCV connectors with BROWN colored wires in-line of the stock Crank Position Sensor connectors (Fig. M).
- 14 Route the last pair of connectors with GREEN and BLUE colored wires forward towards the Ignition Coil.

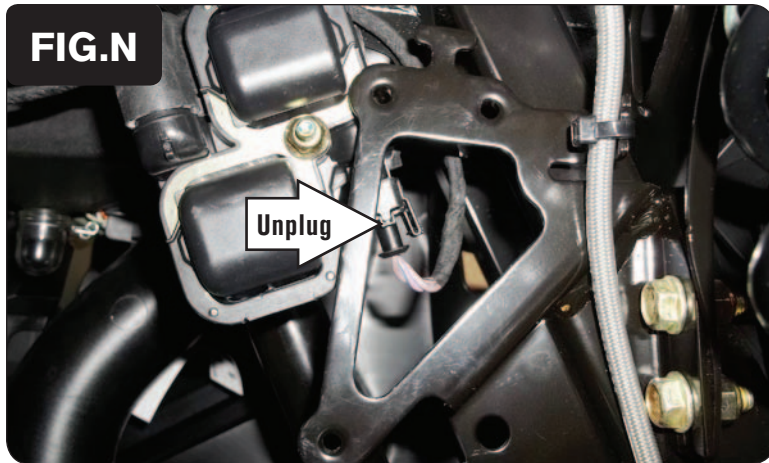

- 15 Unplug the stock wiring harness from the quad's Ignition Coil (Fig. N).
This Ignition Coil is located inside the front right fender well.
If the quad has a Warn winch installed, you may need to remove the winch solenoid to access the coil.

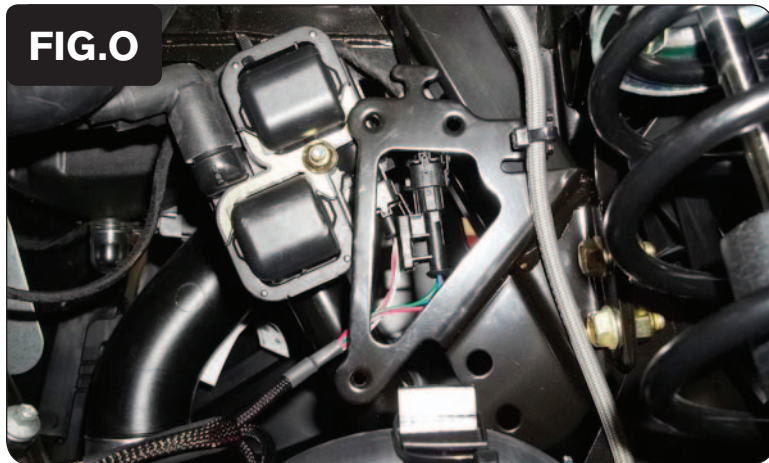

- 16 Plug the pair of 3-pin PCV connectors with BLUE and GREEN colored wires in-line of the Ignition Coil and the stock connector (Fig. O).
- 17 Make sure all of the wiring is secure and clear of any hot or moving parts.
- 18 Reinstall the splash guard, all of the removed bodywork, and the seat.