

[POWER COMMANDER V]

FUEL AND IGNITION

2018 Royal Enfield Himalayan

Installation Instructions



PARTS LIST

- 1 Power Commander
- 1 USB Cable
- 1 Installation Guide
- 2 Power Commander Decals
- 2 Dynojet Decals
- 1 Alcohol swab
- 2 Velcro strips

THE IGNITION MUST BE TURNED OFF BEFORE INSTALLATION!

THE LATEST POWER COMMANDER SOFTWARE AND MAP FILES CAN BE DOWNLOADED FROM OUR WEB SITE AT:
www.powercommander.com

PLEASE READ ALL DIRECTIONS BEFORE STARTING INSTALLATION

Dynojet

2191 Mendenhall Drive North Las Vegas, NV 89081 (800) 992-4993 www.powercommander.com

POWER COMMANDER V INPUT ACCESSORY GUIDE

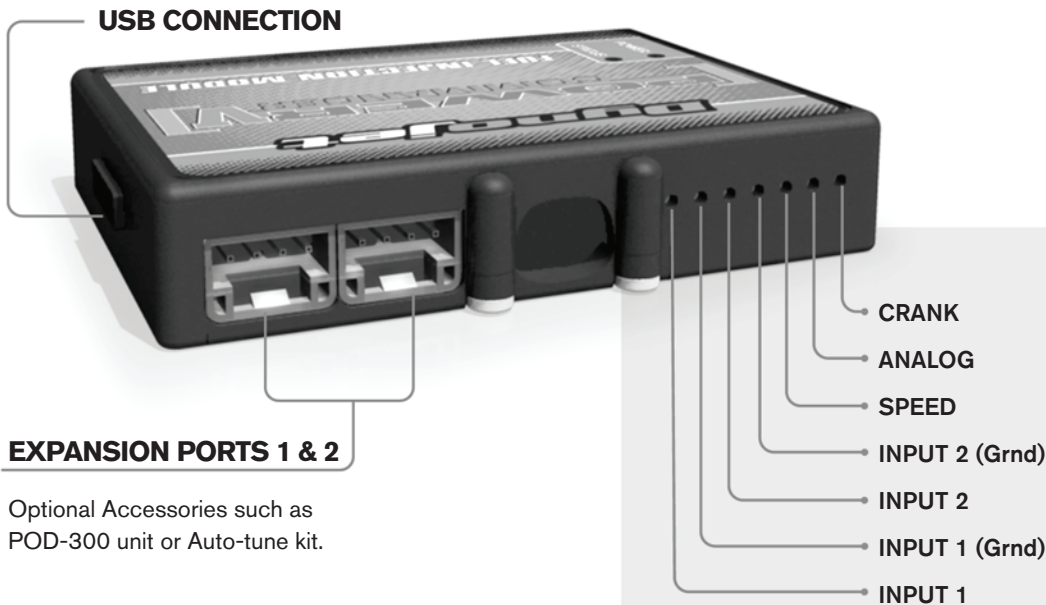

Wire connections:

To input wires into the PCV first remove the rubber plug on the backside of the unit and loosen the screw for the corresponding input. Using a 22-24 gauge wire strip about 10mm from its end. Push the wire into the hole of the PCV until it stops and then tighten the screw. Make sure to reinstall the rubber plug.

NOTE: If you tin the wires with solder it will make inserting them easier.

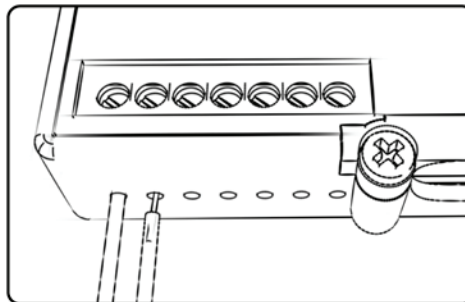

ACCESSORY INPUTS

Map -

(Input 1 or 2) The PCV has the ability to hold 2 different base maps. You can switch on the fly between these two base maps when you hook up a switch to the MAP inputs. You can use any open/close type switch. The polarity of the wires is not important. When using the Autotune kit one position will hold a base map and the other position will let you activate the learning mode. When the switch is "CLOSED" Autotune will be activated. (Set to Switch Input #1 by default.)

Shifter-

(Input 1 or 2) These inputs are for use with the Dynojet quickshifter. Insert the wires from the Dynojet quickshifter into the SHIFTER inputs. The polarity of the wires is not important. (Set to Switch Input #2 by default.)

Speed-

If your application has a speed sensor then you can tap into the signal side of the sensor and run a wire into this input. This will allow you to calculate gear position in the Control Center Software. Once gear position is setup you can alter your map based on gear position and setup gear dependent kill times when using a quickshifter.

Analog-

This input is for a 0-5v signal such as engine temp, boost, etc. Once this input is established you can alter your fuel curve based on this input in the control center software.

Crank-

Do **NOT** connect anything to this port unless instructed to do so by Dynojet. It is used to transfer crank trigger data from one module to another.

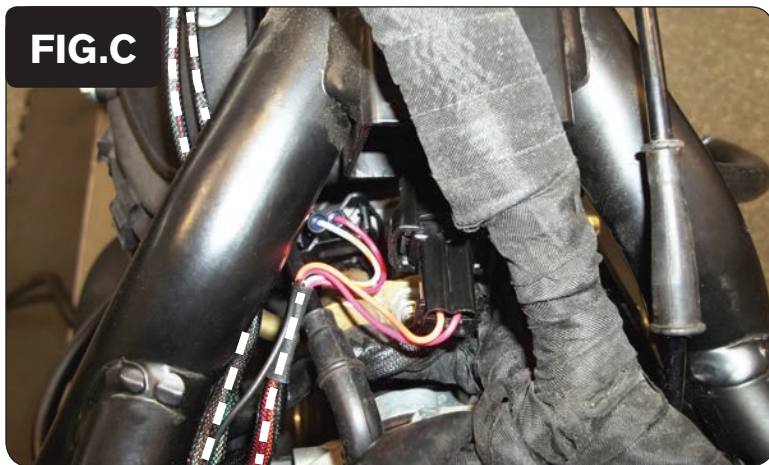
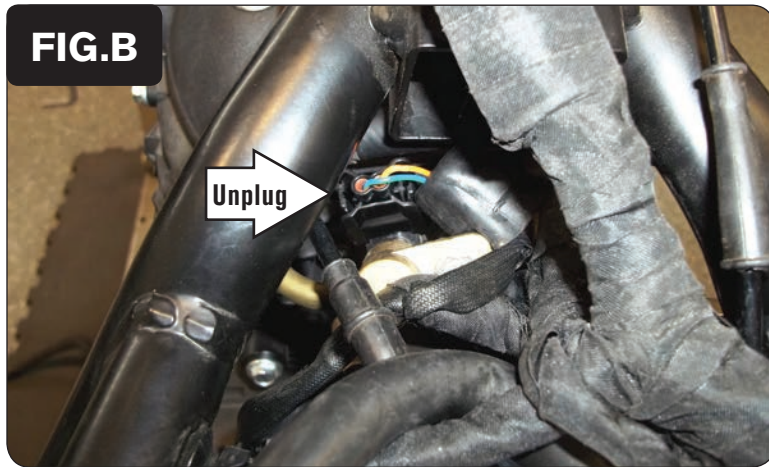
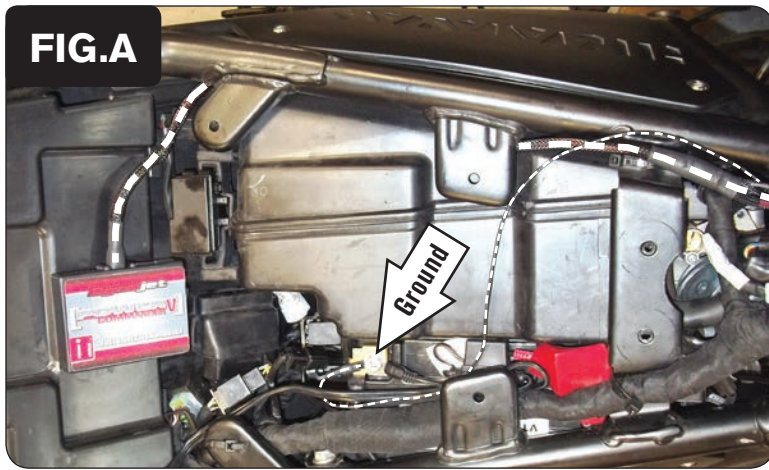

- 1 Remove the seat and the fuel tank.
- 2 Install the PCV module under the seat in the location shown in Figure A.
Secure the PCV module with the supplied Velcro. Use the alcohol swab to clean surfaces before attaching the Velcro.
- 3 Route the PCV wiring harness forward following beneath the left frame rail.
- 4 Secure the PCV ground wire with the small ring terminal to the negative (-) terminal of the bike's battery.
- 5 Unplug the stock wiring harness from the Fuel Injector (Fig. B).
- 6 Plug the pair of PCV connectors with ORANGE colored wires in-line of the Fuel Injector and the stock wiring harness (Fig. C).

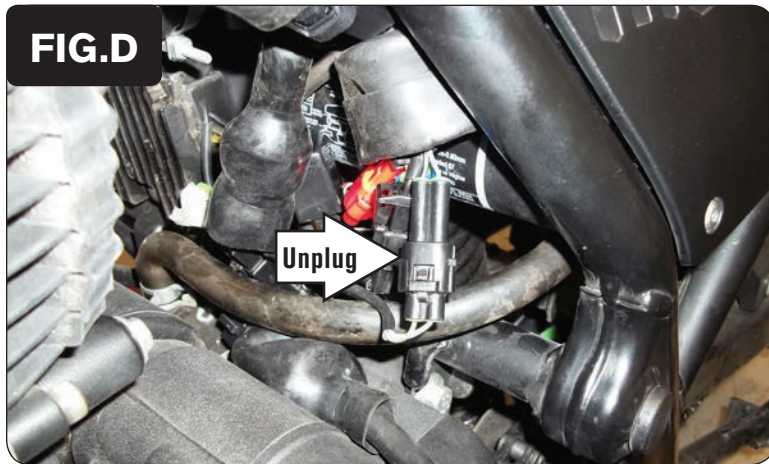

7 Unplug the stock Crank Position Sensor connectors (Fig. D).



8 Plug the pair of PCV connectors with BROWN colored wires in-line of the stock Crank Position Sensor connectors (Fig. E).



9 Unplug the stock wiring harness from the Throttle Position Sensor (Fig. F).



- 10 Plug the pair of 3-pin PCV connectors with GREY wires in-line of the Throttle Position Sensor and the stock wiring harness (Fig. G).

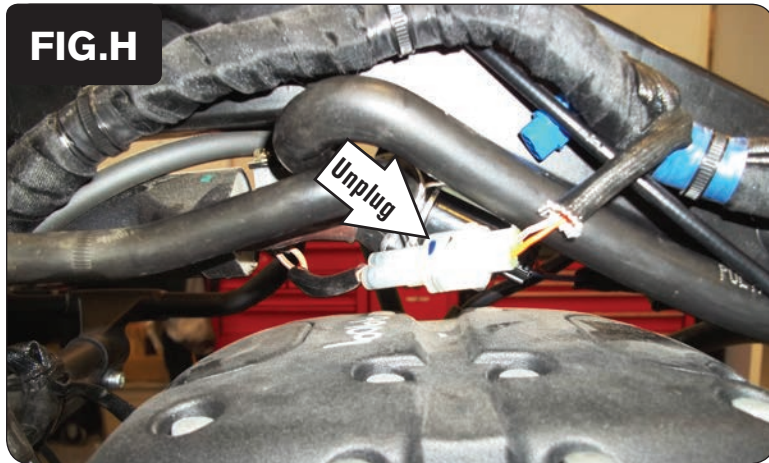

- 11 Unplug the stock Ignition Coil connectors (Fig. H).



- 12 Plug the pair of PCV connectors with GREEN colored wires in-line of the stock Ignition Coil connectors (Fig. J).
- 13 Reinstall the fuel and the seat.