

[POWER COMMANDER V]

2017 Harley Davidson Touring Model

Installation Instructions



PARTS LIST

- 1 Power Commander
- 1 USB Cable
- 1 Installation Guide
- 2 Power Commander Decals
- 2 Dynojet Decals
- 2 Velcro strips
- 1 Alcohol swab
- 1 Front O2 Optimizer
- 1 Rear O2 Optimizer

THE IGNITION MUST BE TURNED OFF BEFORE INSTALLATION!

THE LATEST POWER COMMANDER SOFTWARE AND MAP FILES CAN BE DOWNLOADED FROM OUR WEB SITE AT:
www.powercommander.com

PLEASE READ ALL DIRECTIONS BEFORE STARTING INSTALLATION

Dynojet

2191 Mendenhall Drive North Las Vegas, NV 89081 (800) 992-4993 www.powercommander.com

POWER COMMANDER V INPUT ACCESSORY GUIDE

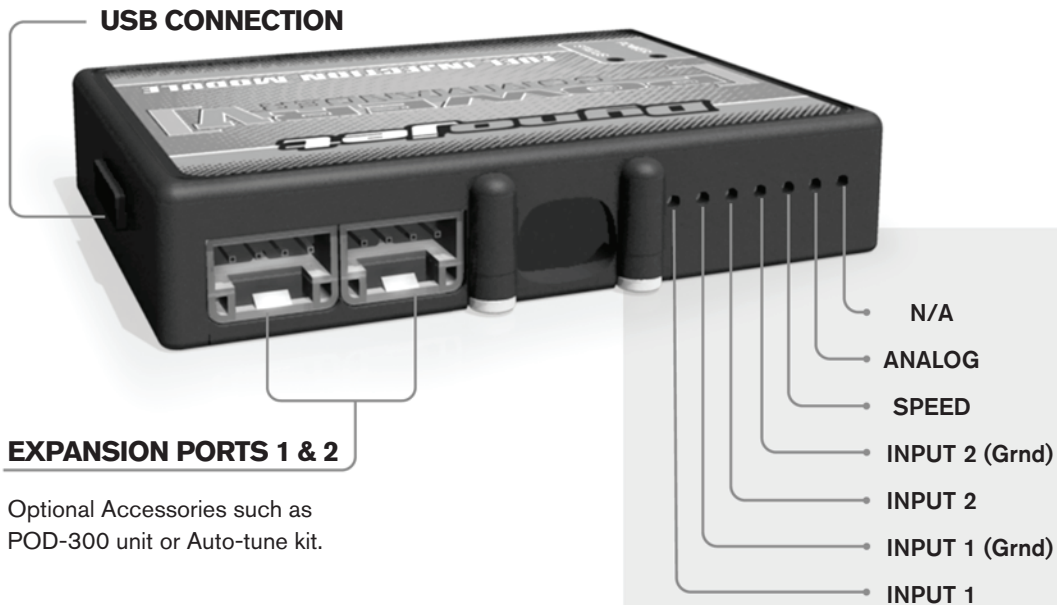

Wire connections:

To input wires into the PCV first remove the rubber plug on the backside of the unit and loosen the screw for the corresponding input. Using a 22-24 gauge wire strip about 10mm from its end. Push the wire into the hole of the PCV until it stops and then tighten the screw. Make sure to reinstall the rubber plug.

NOTE: If you tin the wires with solder it will make inserting them easier.

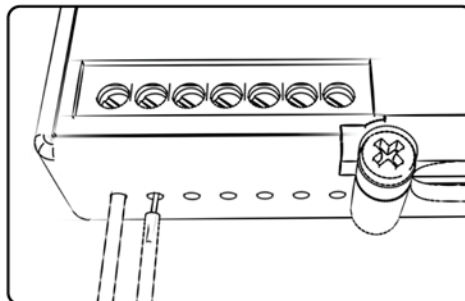

ACCESSORY INPUTS

Map -

(Input 1 or 2) The PCV has the ability to hold 2 different base maps. You can switch on the fly between these two base maps when you hook up a switch to the MAP inputs. You can use any open/close type switch. The polarity of the wires is not important. When using the Autotune kit one position will hold a base map and the other position will let you activate the learning mode. When the switch is "CLOSED" Autotune will be activated. (Set to Switch Input #1 by default.)

Shifter-

(Input 1 or 2) Used for clutch-less full throttle upshifts. Insert the wires from the Dynojet quickshifter into either INPUT 1 or INPUT 2. The polarity of the wires is not important. (Set to Switch Input #2 by default.)

Speed-

Not needed on Harley applications as the speed signal wire is built into the main wiring harness of the PCV.

Analog-

This input is for a 0-5v signal such as engine temp, boost, etc. Once this input is established you can alter your fuel curve based on this input in the control center software.

Launch-

You can connect a wire to either input 1 or 2 and then the other end to a switch. This switch when engaged (continuity) will only allow the RPM to be raised to a certain limit (Set in the software). When released you will have full RPM.

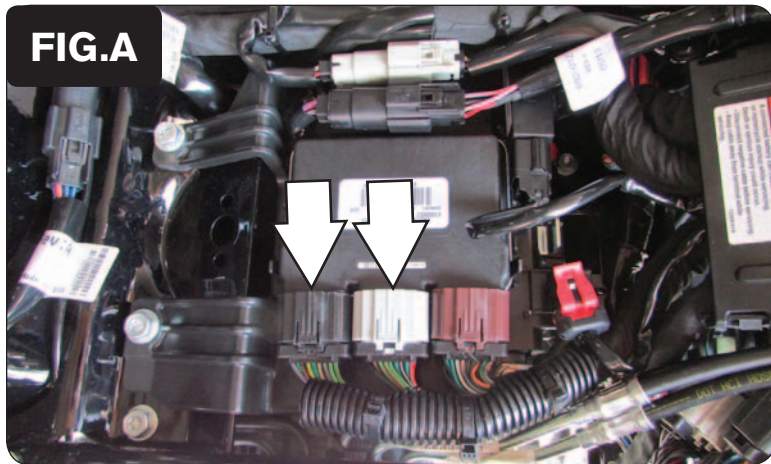

- 1 Remove the stock seat and the right side panel
- 2 Unplug the BLACK and GREY connectors from the ECM (Fig. A) .

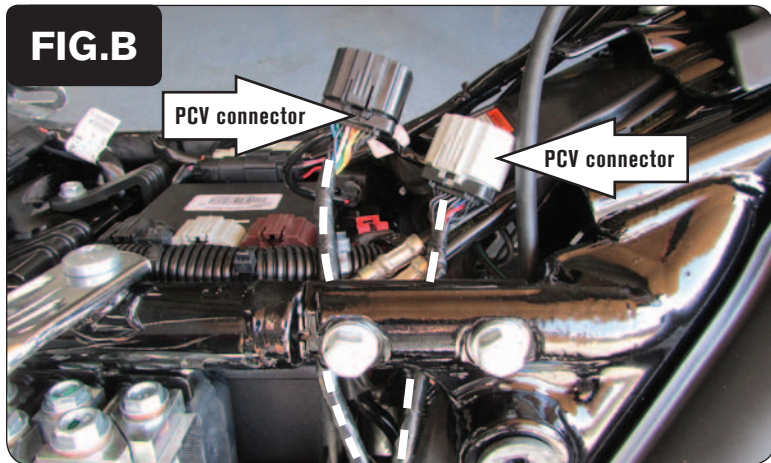

- 3 Route the Female connectors of the PCV behind the frame tube on the right side of the bike as in Figure B. Slide the harness towards the rear of the bike.

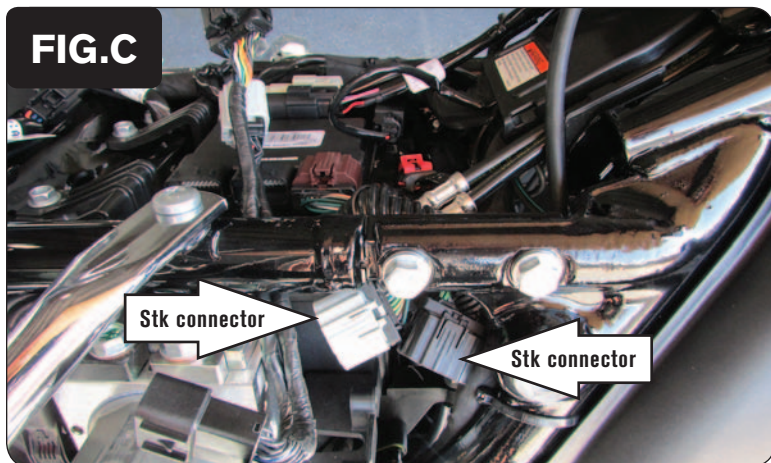

- 4 Route the stock ECM connectors that were disconnected in step 2 under the frame tube as in Figure C.

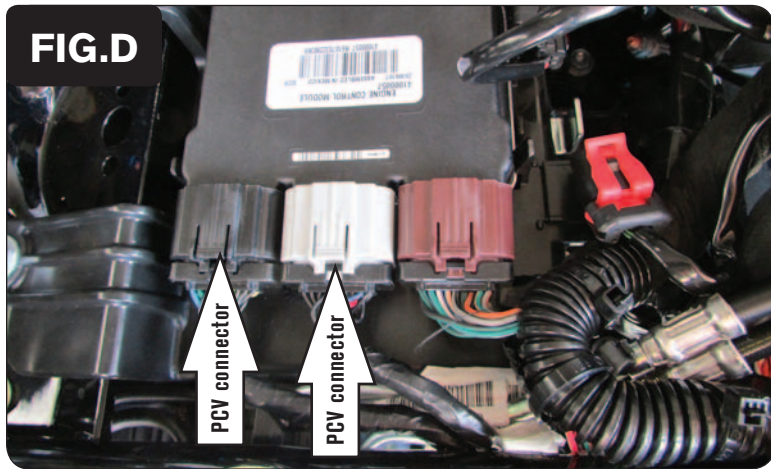

- 5 Plug the PCV connectors into the stock ECM (Fig. D).

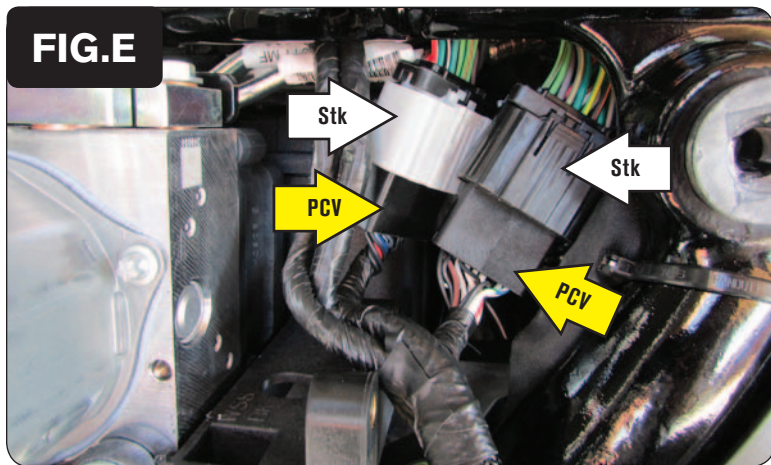

- 6 Plug the Male connectors of the PCV into the stock Female connectors (Fig. E).



- 7 Secure the PCV under the right hand side cover using the supplied Velcro.

Make sure to clean the surface with the alcohol swab before attaching.

Figure F is shown on the ABS model. Non ABS models will have more options of where to place the unit.

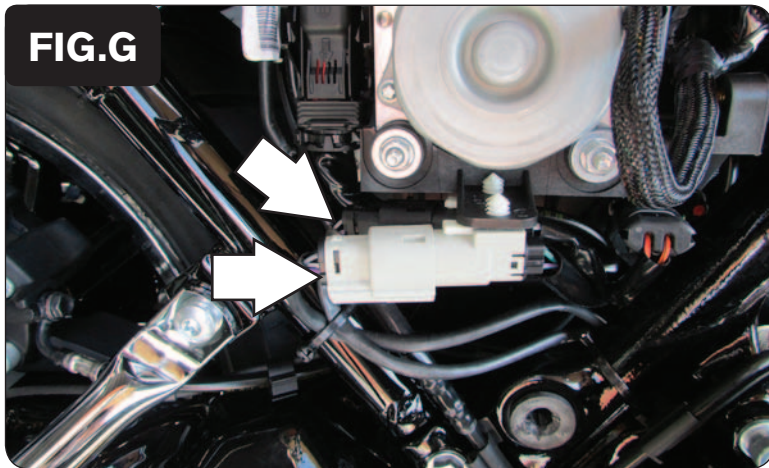

- 8 Locate the stock O2 sensor connections and unplug both connectors (Fig. G).
There is a GREY 4 pin and a BLACK 4 pin connector under the right hand side cover.

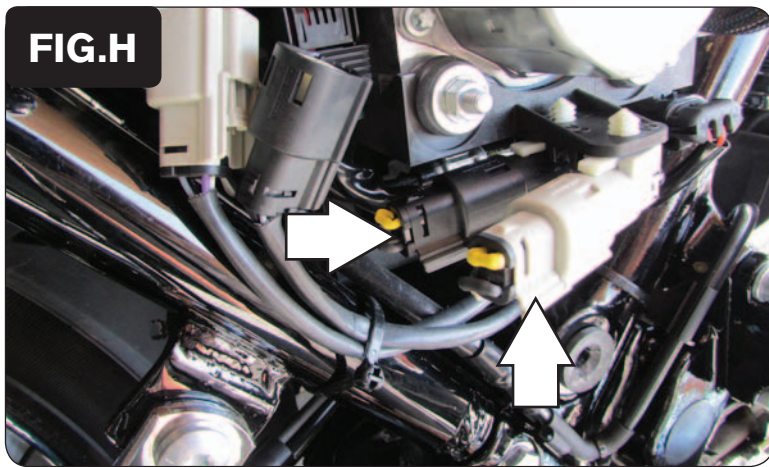

- 9 Plug the Dynojet O2 Optimizers into the stock wiring harness (Fig. H).
The stock O2 sensors will NOT be connected to anything at this time. The sensors can be removed from the exhaust if you have a way to plug the hole.

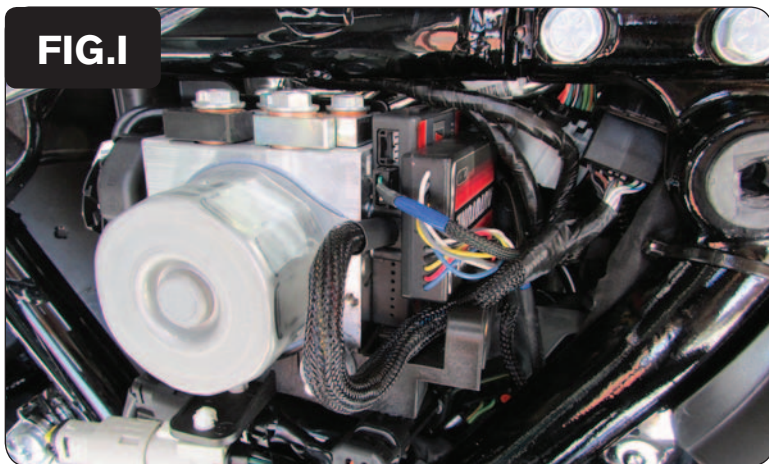

**Follow these instructions when using the Auto tune kit - (PN: AT-101B).
Refer to the Autotune install guide for the correct O2 sensor placement.**

- 1 Remove the left hand side cover.
- 2 Place the Autotune module next to the PCV as shown in Figure I.

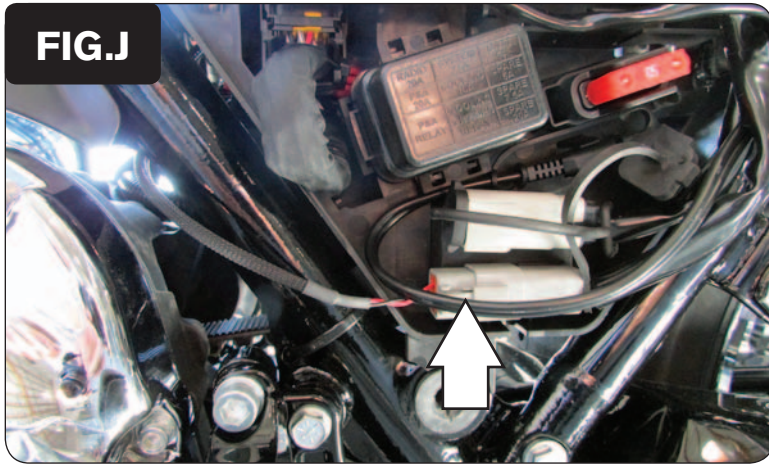

- 3 Route the 6-pin power plug from the Autotune from the right side of the bike and go in front of the battery to the right side of the bike.
- 4 Plug the Autotune power lead into the diagnostic port under the left hand side cover (Fig. J).

Secure the Autotune lead so it does not get caught in the drive belt.

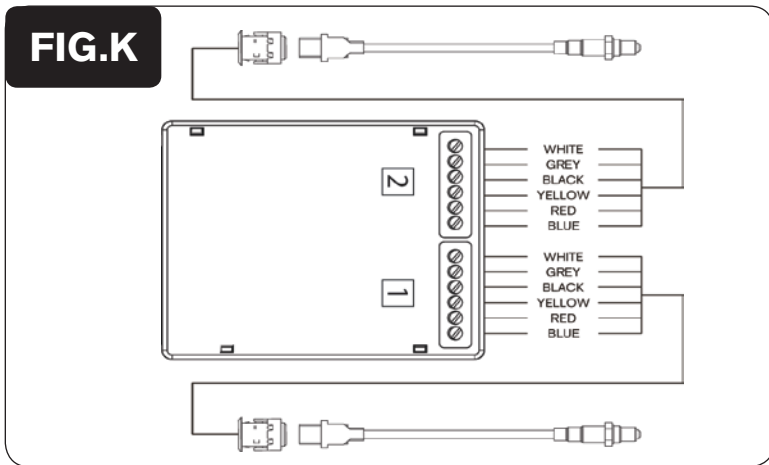

- 5 Connect the longer harness to the front O2 sensor and then connect to Autotune AT#1. Wire the harness to the module per Figure K. The harness can be cut to length if desired.
- 6 Repeat step 5 for the rear cylinder. Wire the harness to Autotune module AT#2. The harness can be cut to length if desired.

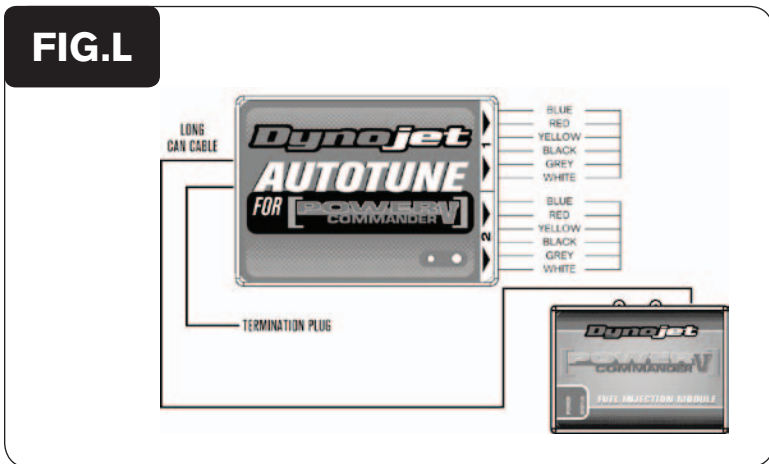

- 7 Use the CAN cable to connect the Autotune module to the PCV. It does not matter what ports are used.
- 8 Install the CAN termination plug into the open port of the Autotune module. ***This is the BLACK plastic connector in the kit (PN: 76423025). It is critical that this piece be installed and it is often overlooked.***
- 9 Secure the harnesses in place as to not contact the exhaust.
- 10 Reinstall the side cover.

In the PCV software go to Power Commander Tools - Configure - Features, Enables, and Input Selections to enable and configure the Auto-tune feature.

Go to www.powercommander.com for the latest maps and software updates.