

[POWER COMMANDER V]

**2014-2015 Triumph Thunderbird
LT / Commander models**

Installation Instructions



PARTS LIST

- 1 Power Commander
- 1 USB Cable
- 1 Installation Guide
- 2 Power Commander Decals
- 2 Dynojet Decals
- 2 Velcro strips
- 1 Alcohol swab
- 2 O2 Optimizers
- 1 Zip tie

**THE IGNITION MUST BE TURNED
OFF BEFORE INSTALLATION!**

THE LATEST POWER COMMANDER
SOFTWARE AND MAP FILES CAN BE
DOWNLOADED FROM OUR WEB SITE AT:
www.powercommander.com

PLEASE READ ALL DIRECTIONS BEFORE STARTING INSTALLATION

Dynojet

2191 Mendenhall Drive North Las Vegas, NV 89081 (800) 992-4993 www.powercommander.com

POWER COMMANDER V INPUT ACCESSORY GUIDE

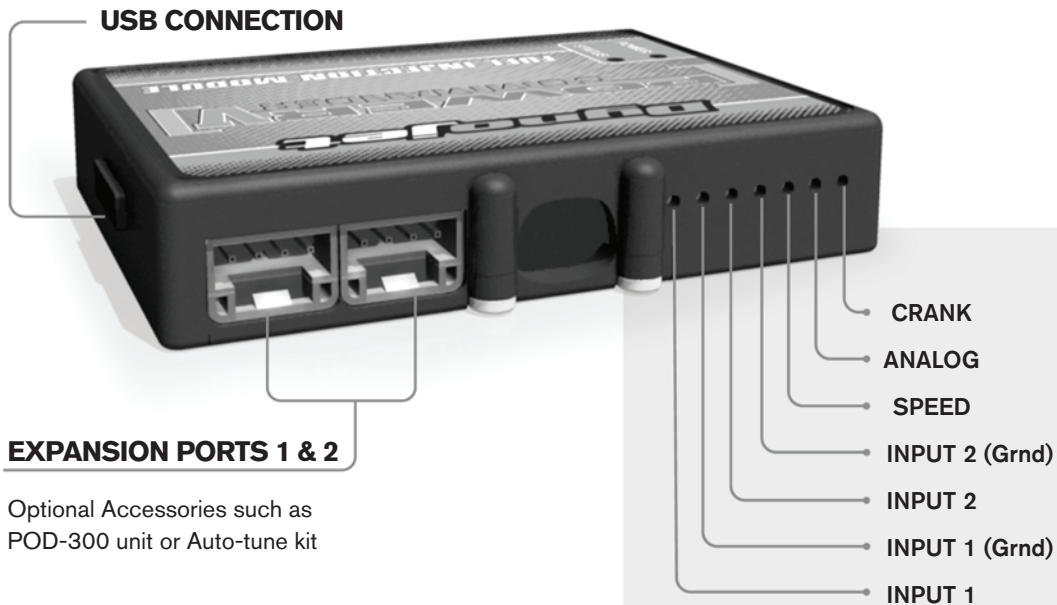

Optional Accessories such as
POD-300 unit or Auto-tune kit

Wire connections:

To input wires into the PCV first remove the rubber plug on the backside of the unit and loosen the screw for the corresponding input. Using a 22-24 gauge wire strip about 10mm from its end. Push the wire into the hole of the PCV until it stops and then tighten the screw. Make sure to reinstall the rubber plug.

NOTE: If you tin the wires with solder it will make inserting them easier.

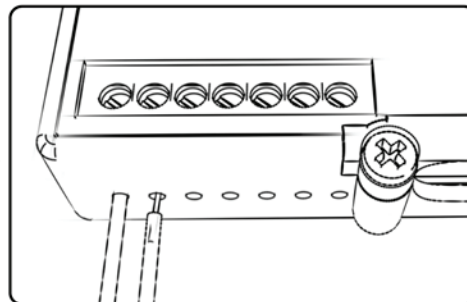

ACCESSORY INPUTS

Map -

(Input 1 or 2) The PCV has the ability to hold 2 different base maps. You can switch on the fly between these two base maps when you hook up a switch to the MAP inputs. You can use any open/close type switch. The polarity of the wires is not important. When using the Autotune kit one position will hold a base map and the other position will let you activate the learning mode. When the switch is "CLOSED" Autotune will be activated. (Set to Switch Input #1 by default.)

Shifter-

(Input 1 or 2) These inputs are for use with the Dynojet quickshifter. Insert the wires from the Dynojet quickshifter into the SHIFTER inputs. The polarity of the wires is not important. (Set to Switch Input #2 by default.)

Speed-

If your application has a speed sensor then you can tap into the signal side of the sensor and run a wire into this input. This will allow you to calculate gear position in the Control Center Software. Once gear position is setup you can alter your map based on gear position and setup gear dependent kill times when using a quickshifter.

Analog-

This input is for a 0-5v signal such as engine temp, boost, etc. Once this input is established you can alter your fuel curve based on this input in the control center software.

Crank-

Do **NOT** connect anything to this port unless instructed to do so by Dynojet. It is used to transfer crank trigger data from one module to another.

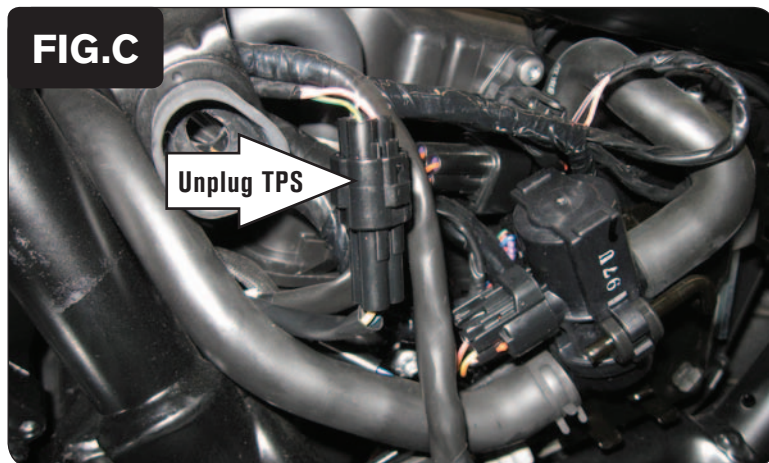
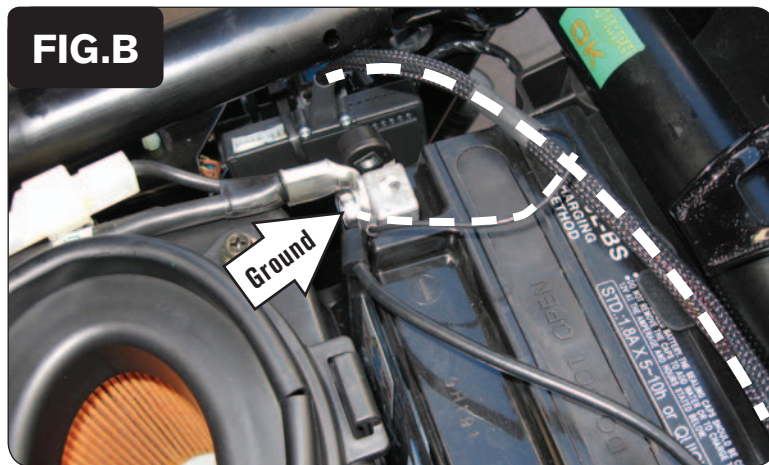
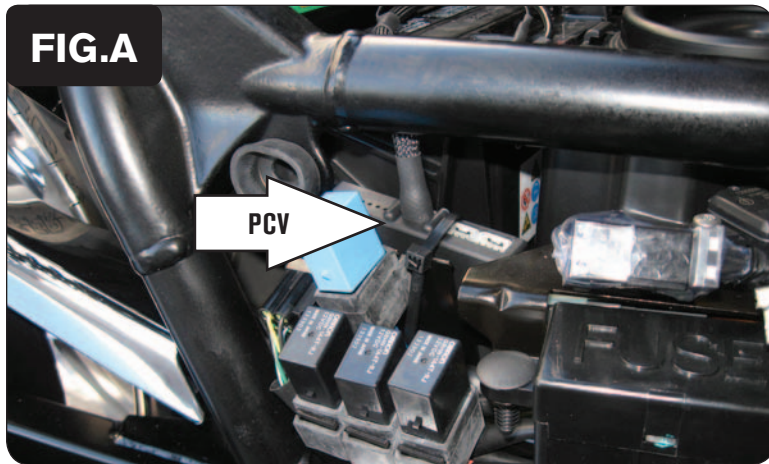

- 1 Remove the seat.
- 2 Remove the right and left side covers.
- 3 Install the PCV under the right side cover near the fuse box assembly (Fig. A).

Use the supplied zip tie to secure the PCV in place. You could also use the supplied Velcro to secure and store the module in an alternate location, if necessary. If so, clean both surfaces with the supplied alcohol swab prior to applying the Velcro adhesive.

- 4 Secure the ground wire of the PCV with the small ring lug to the negative (-) terminal of the bike's battery (Fig. B).
- 5 Route the PCV harness to the left side of the bike and go towards the throttle bodies.

- 6 Locate the stock Throttle Position Sensor connectors under the left hand side cover. Unplug these connectors (Fig. C).

This is the BLACK 3-pin connector pair.

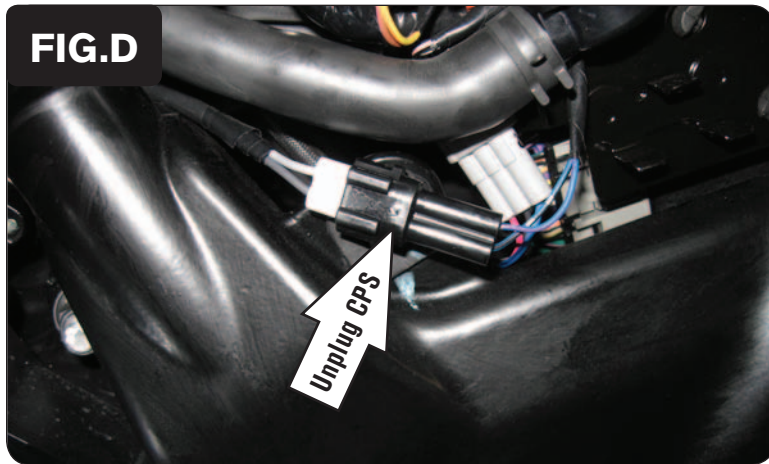

- 7 Locate the Crank Position Sensor connectors under the left hand side cover. Unplug this connector pair (Fig. C).

This is the BLACK to WHITE 2-pin connector pair which may be hidden behind the hose shown in Figure D.



- 8 Plug the connectors from the PCV in-line of the stock Throttle Position Sensor connectors and the stock Crank Position Sensor connectors (Fig. E).

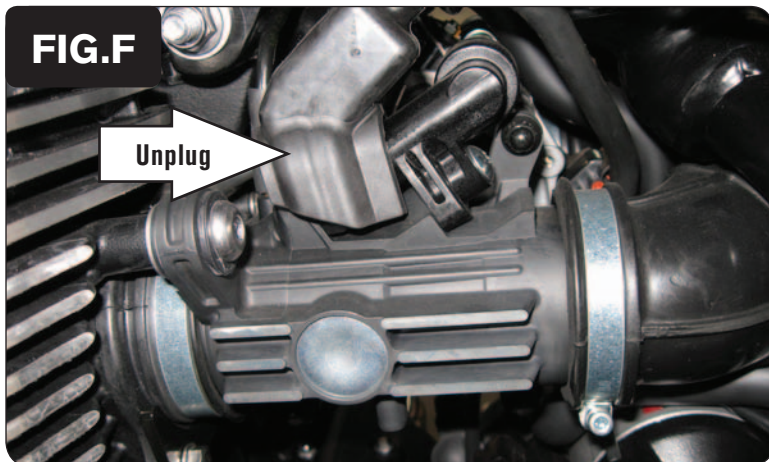

- 9 Unplug the stock wiring harness from both fuel injectors (Fig. F).

These connectors are covered by a rubber boot.

FIG.G

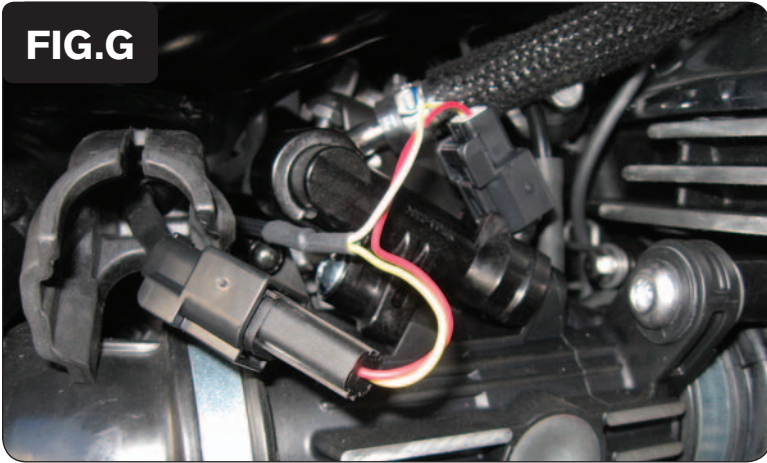

- 10 Plug the PCV connectors in-line of the stock wiring harness and fuel injector for both cylinders (Fig. G).

The PCV connector pair with ORANGE colored wires should go to the left cylinder fuel injector.

For a cleaner install you can remove the rubber boot from the stock wiring harness and put it on the PCV connectors but it is very difficult. You will need to remove the pins from stock connectors and the PCV connectors to slide the rubber boot on/off of them.

- 11 Locate both of the stock O2 sensor connectors.

This is under the front of the engine near the crossover pipe. You can follow the wires out of each exhaust pipe and follow them to this location.

- 12 Unplug both O2 sensors from the stock wiring harness and plug the supplied O2 Optimizers into the wiring harness in-place of the stock O2 sensors.

The stock O2 sensors will no longer be connected to anything. They can be removed from the exhaust if desired and if you have a way to plug the holes left in the exhaust.