

[POWER COMMANDER V]

2016 Triumph ThruxtonR

Installation Instructions



PARTS LIST

- 1 Power Commander
- 1 USB Cable
- 1 Installation Guide
- 2 Power Commander Decals
- 2 Dynojet Decals
- 2 Velcro
- 1 Alcohol swab
- 2 O2 Optimizers

THE IGNITION MUST BE TURNED OFF BEFORE INSTALLATION!

YOU CAN ALSO DOWNLOAD THE POWER COMMANDER SOFTWARE AND LATEST MAPS FROM OUR WEB SITE AT:
www.powercommander.com

PLEASE READ ALL DIRECTIONS BEFORE STARTING INSTALLATION

Dynojet

2191 Mendenhall Drive North Las Vegas, NV 89081 (800) 992-4993 www.powercommander.com

POWER COMMANDER V INPUT ACCESSORY GUIDE

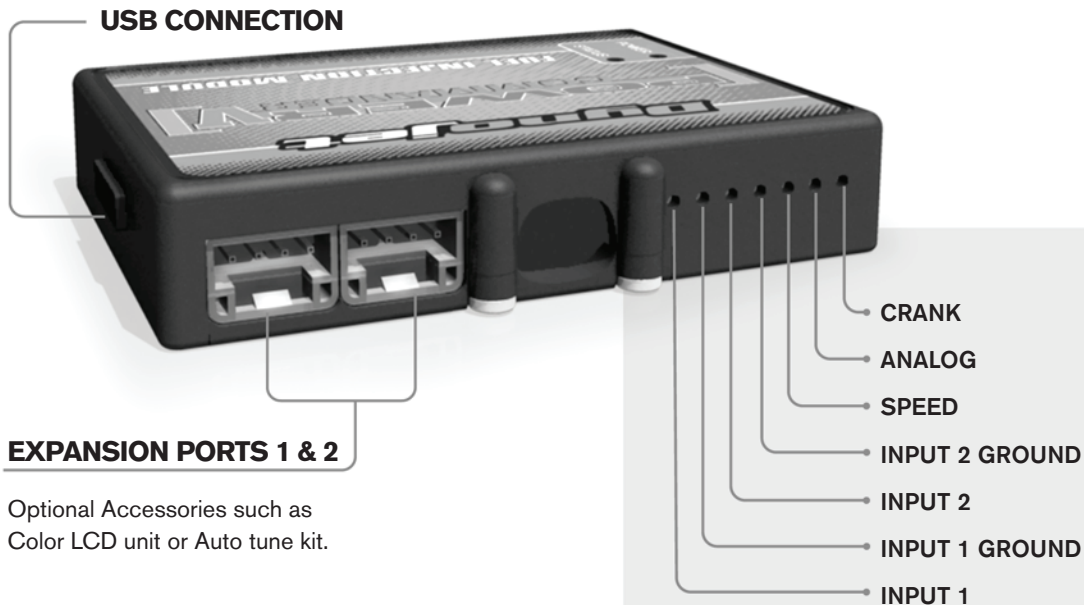

Optional Accessories such as Color LCD unit or Auto tune kit.

Wire connections:

To input wires into the PCV first remove the rubber plug on the backside of the unit and loosen the screw for the corresponding input. Using a 22-24 gauge wire strip about 10mm from its end. Push the wire into the hole of the PCV until it stops and then tighten the screw. Make sure to reinstall the rubber plug.

NOTE: If you tin the wires with solder it will make inserting them easier.

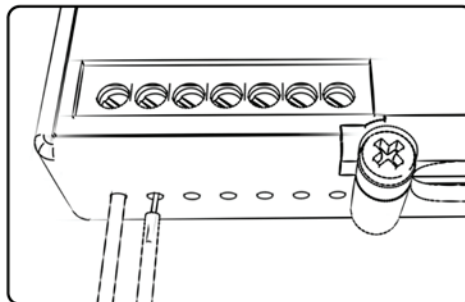

ACCESSORY INPUTS

Map -

The PCV has the ability to hold 2 different base maps. You can switch on the fly between these two base maps when you hook up a switch to input 1 or 2. You can use any open/close type switch. The polarity of the wires is not important. When using the Autotune kit one position will hold a base map and the other position will let you activate the learning mode. When the switch is "CLOSED" Autotune will be activated.

Shifter-

These inputs are for use with the Dynojet quickshifter. Insert the wires from the Dynojet quickshifter into input 1 or 2. The polarity of the wires is not important.

Speed-

If your application has a speed sensor then you can tap into the signal side of the sensor and run a wire into this input. This will allow you to calculate gear position in the Control Center Software. Once gear position is setup you can alter your map based on gear position and setup gear dependent kill times when using a quickshifter.

Analog-

This input is for a 0-5v signal such as engine temp, boost, etc. Once this input is established you can alter your fuel curve based on this input in the control center software.

Crank-

Do **NOT** connect anything to this port unless instructed to do so by Dynojet. It is used to transfer crank trigger data from one module to another.

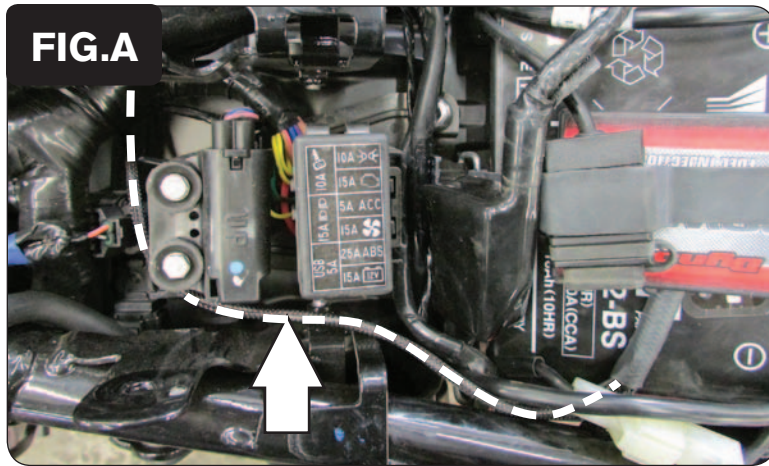

- 1 Remove the seat.
- 2 Remove the fuel tank and both side panels.
- 3 Lay the PCV on top of the battery temporarily.
- 4 Route the branch of the PCV harness with the WHITE, 2 pin connectors around the front of the tip over sensor and go towards the right hand side of the motorcycle (Fig. A).



- 5 Locate the stock Crank Position Sensor on the right hand side of the motorcycle and unplug it (Fig. B).

This 2 pin BLACK connector is located behind the rear brake master cylinder reservoir. It is easiest to remove the bolt holding the reservoir in place to access this connector.

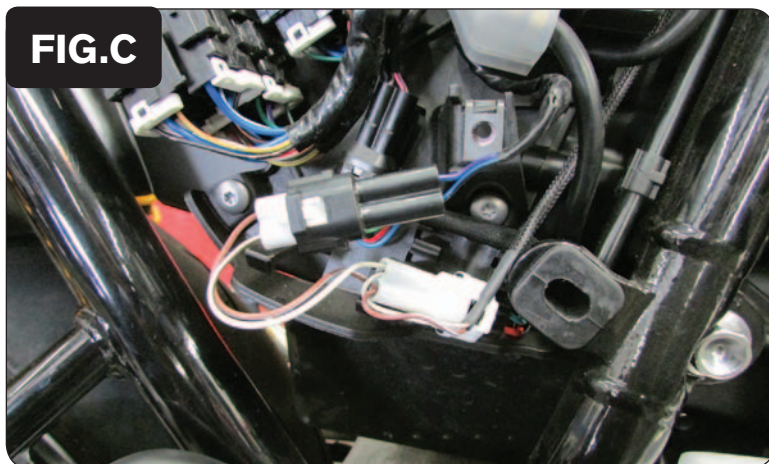

- 6 Plug the PCV in-line of the stock CPS and wiring harness (Fig. C).

Reinstall the brake reservoir if it was removed.

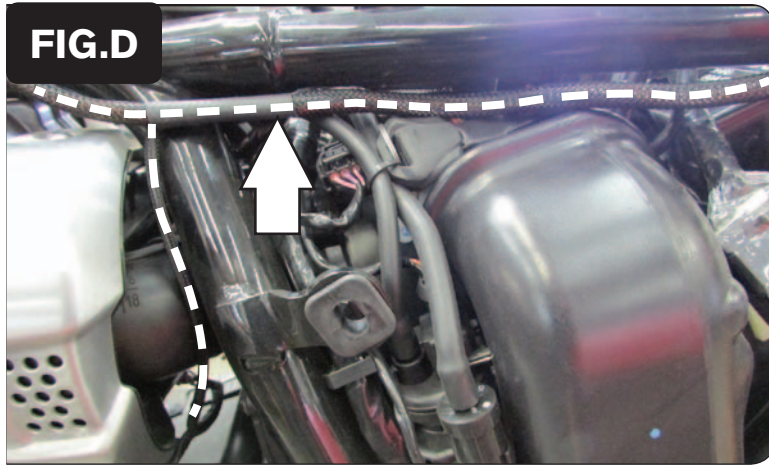

- 7 Route the remaining branch of the PCV down the left side of the frame (Fig. D).

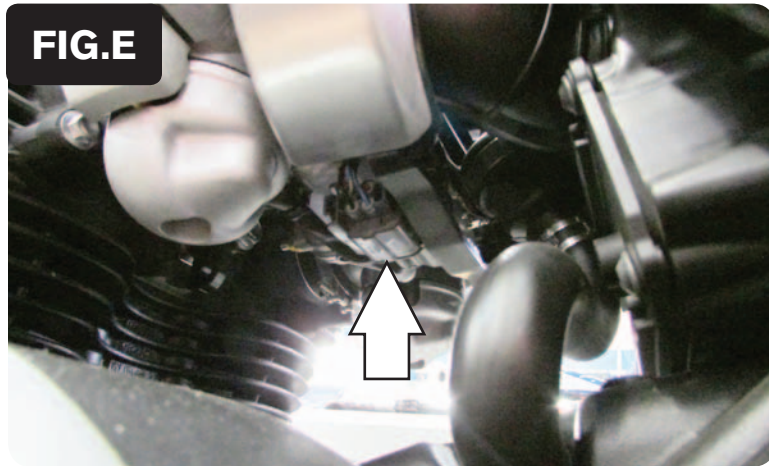

- 8 Unplug the stock Throttle Position Sensor connector(Fig. E).

This is a GREY 4 pin connector at the bottom of the throttle bodies. You can squeeze the right end of the connector and slide it to the right to get them off of their bracket.



- 9 Plug the PCV in-line of the TPS and wiring harness (Fig. F).

Secure one set of connectors back onto the stock bracket

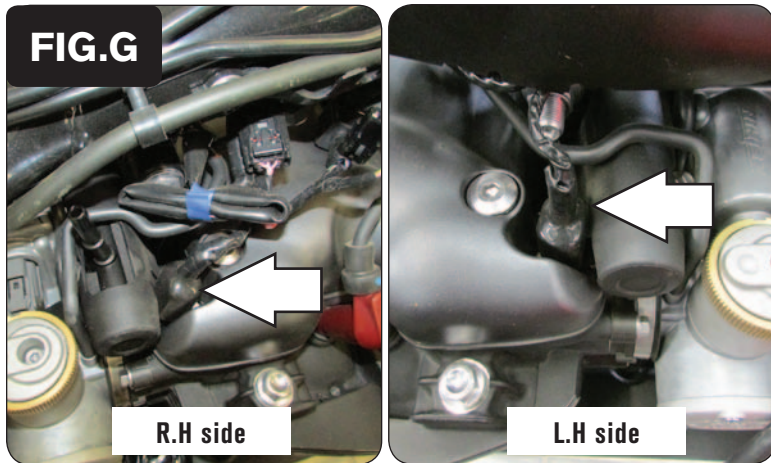

- 10 Unplug the stock wiring harness from each injector (Fig. G).
These connections are under a rubber boot.

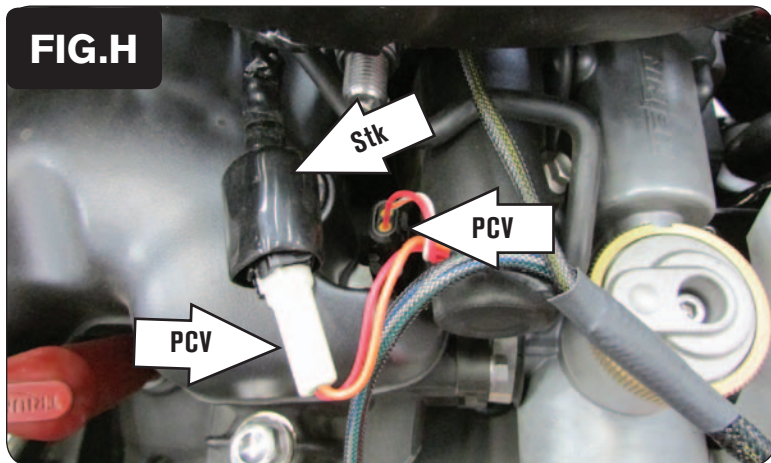

- 11 Plug the PCV in-line of stock injector and wiring harness (Fig. H).
The ORANGE colored wires go to cylinder #1 (left).
The YELLOW colored wires go to cylinder #2 (right).

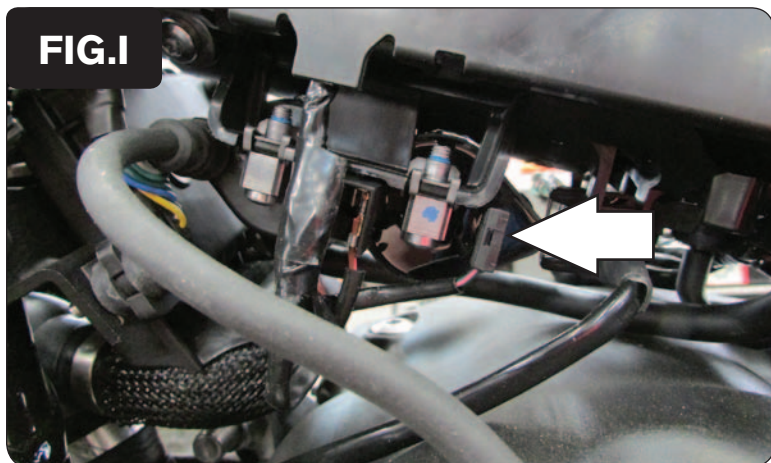

- 12 Unplug the signal wire of stock wiring harness from the #2 ignition coil (Fig. I).
This wire is accessed from the left side of the motorcycle. It is the GREEN/PINK wire.

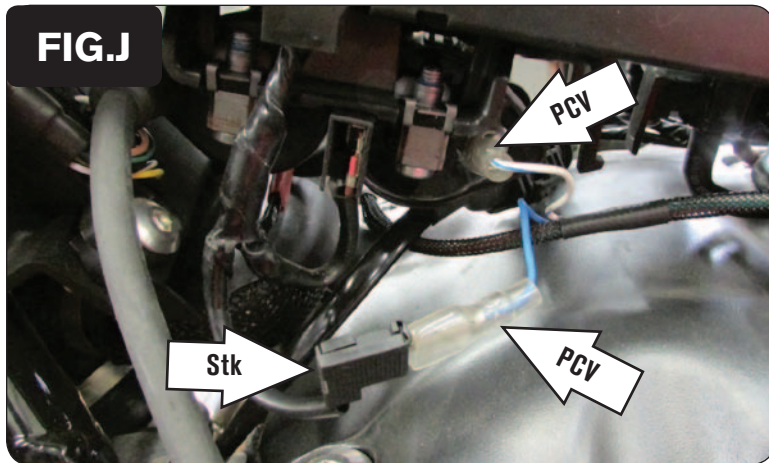

- 13 Plug the BLUE colored wires from the PCV in-line of the stock wiring harness and ignition coil (Fig. J).

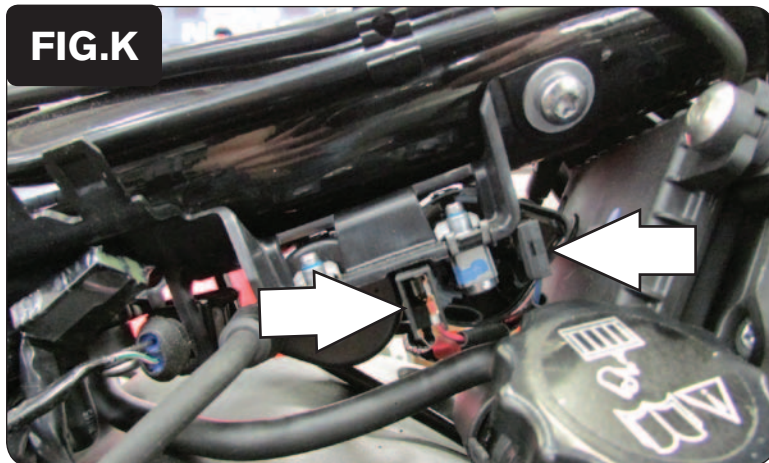

- 14 Unplug the stock wiring harness from the #1 ignition coil (Fig. K).
These wires are accessed from the right side of the motorcycle.

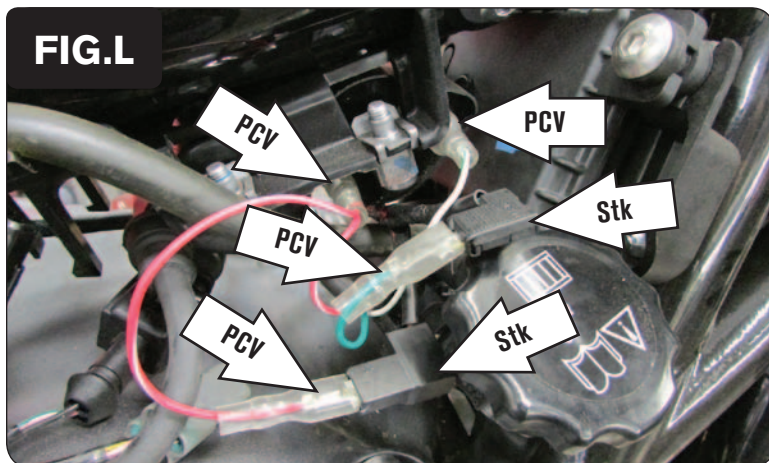

- 15 Plug the PCV in-line of the stock wiring harness and ignition coil (Fig. L).
The GREEN colored wires go in-line of the stock GREEN/PURPLE
The RED colored wires go in-line of the stock BROWN/PINK

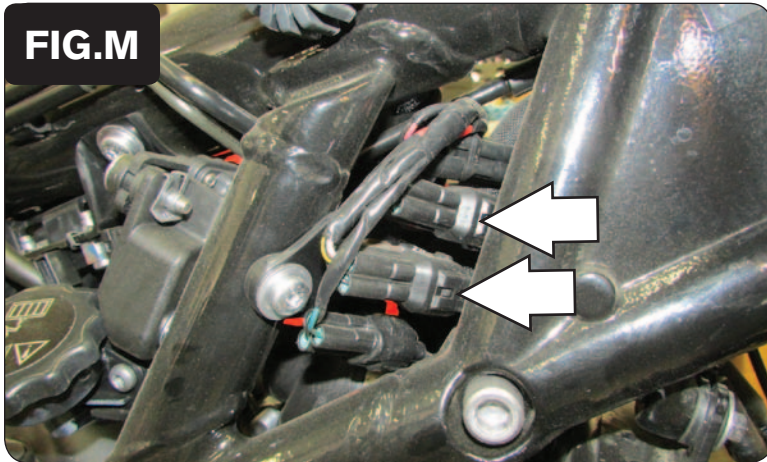

- 16 Unplug the stock O2 sensor connectors (Fig. M).

These connectors are located on the right side of the motorcycle towards the front of the frame.

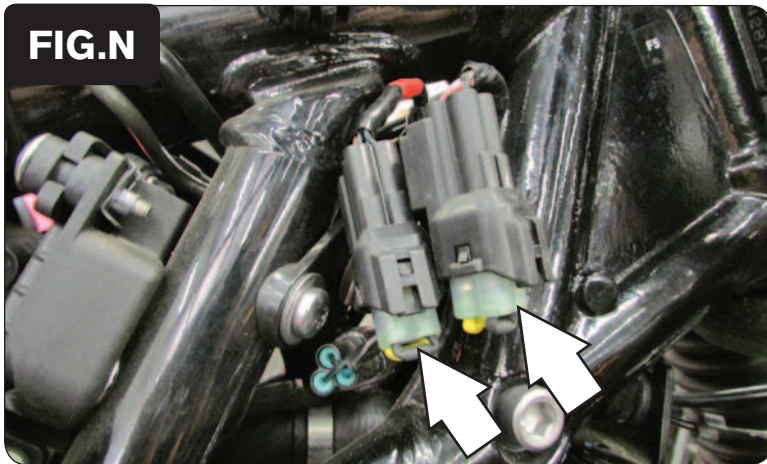

- 17 Plug the supplied Dynojet O2 Optimizers into the stock wiring harness (Fig. N).

The stock O2 sensors will no longer be connected to anything and can be removed if desired.

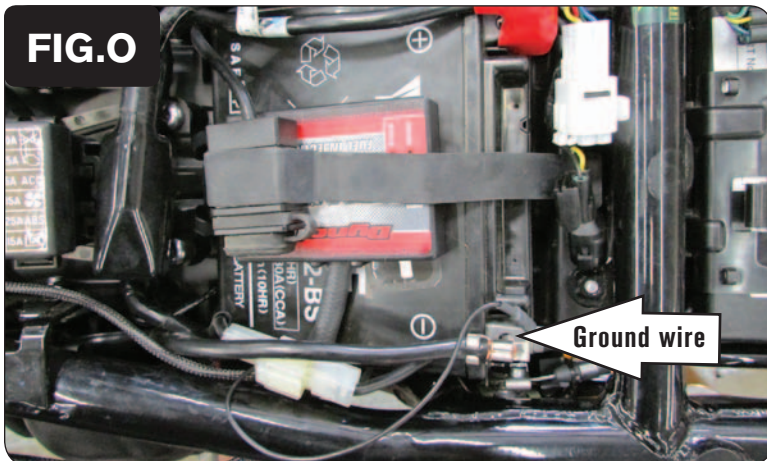

- 18 Secure the PCV on top of the battery using the stock rubber hold down strap (Fig. O).

- 19 Attach the ground wire of the PCV to the negative (-) side of the battery (Fig. O).

- 20 Reinstall the bodywork.