

[POWER COMMANDER V]

2015 Yamaha YZF R1 Installation Instructions



PARTS LIST

- 1 Power Commander
- 1 USB Cable
- 1 Installation Guide
- 2 Power Commander Decals
- 2 Dynojet Decals
- 2 Velcro strips
- 1 Alcohol swab
- 1 Posi-tap

**THE IGNITION MUST BE TURNED
OFF BEFORE INSTALLATION!**

THE LATEST POWER COMMANDER
SOFTWARE AND MAP FILES CAN BE
DOWNLOADED FROM OUR WEB SITE AT:
www.powercommander.com

PLEASE READ ALL DIRECTIONS BEFORE STARTING INSTALLATION

Dynojet

2191 Mendenhall Drive North Las Vegas, NV 89081 (800) 992-4993 www.powercommander.com

POWER COMMANDER V INPUT ACCESSORY GUIDE

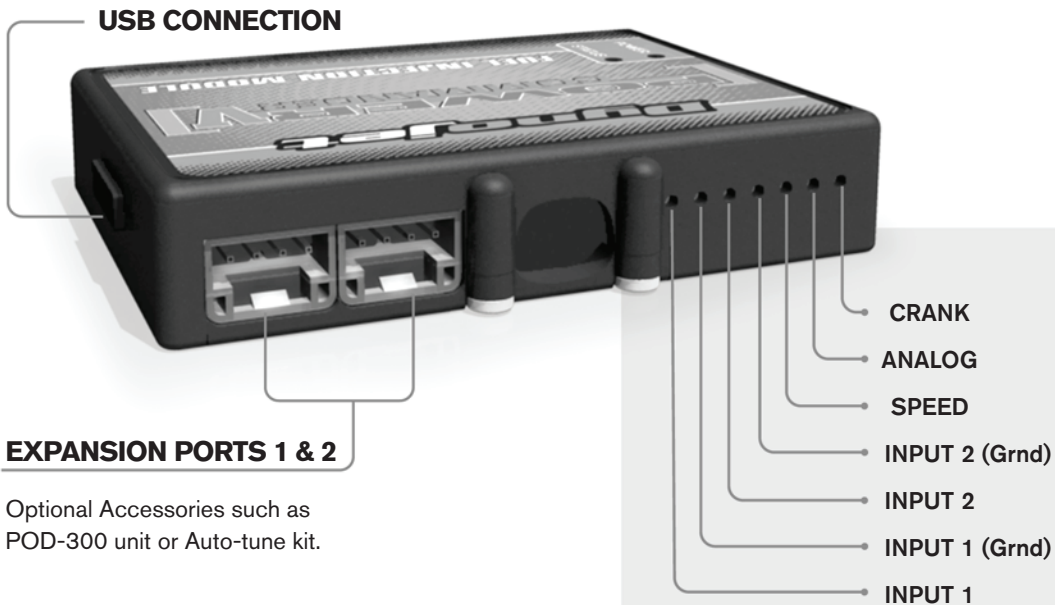

Wire connections:

To input wires into the PCV first remove the rubber plug on the backside of the unit and loosen the screw for the corresponding input. Using a 22-24 gauge wire strip about 10mm from its end. Push the wire into the hole of the PCV until it stops and then tighten the screw. Make sure to reinstall the rubber plug.

NOTE: If you tin the wires with solder it will make inserting them easier.

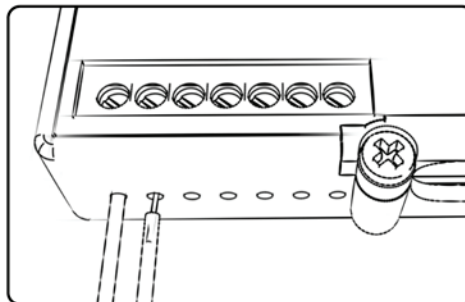

ACCESSORY INPUTS

Map -

(Input 1 or 2) The PCV has the ability to hold 2 different base maps. You can switch on the fly between these two base maps when you hook up a switch to the MAP inputs. You can use any open/close type switch. The polarity of the wires is not important. When using the Autotune kit one position will hold a base map and the other position will let you activate the learning mode. When the switch is "CLOSED" Autotune will be activated. (Set to Switch Input #1 by default.)

Shifter-

(Input 1 or 2) These inputs are for use with the Dynojet quickshifter. Insert the wires from the Dynojet quickshifter into the SHIFTER inputs. The polarity of the wires is not important. (Set to Switch Input #2 by default.)

Speed-

If your application has a speed sensor then you can tap into the signal side of the sensor and run a wire into this input. This will allow you to calculate gear position in the Control Center Software. Once gear position is setup you can alter your map based on gear position and setup gear dependent kill times when using a quickshifter.

Analog-

This input is for a 0-5v signal such as engine temp, boost, etc. Once this input is established you can alter your fuel curve based on this input in the control center software.

Crank-

Do **NOT** connect anything to this port unless instructed to do so by Dynojet. It is used to transfer crank trigger data from one module to another.

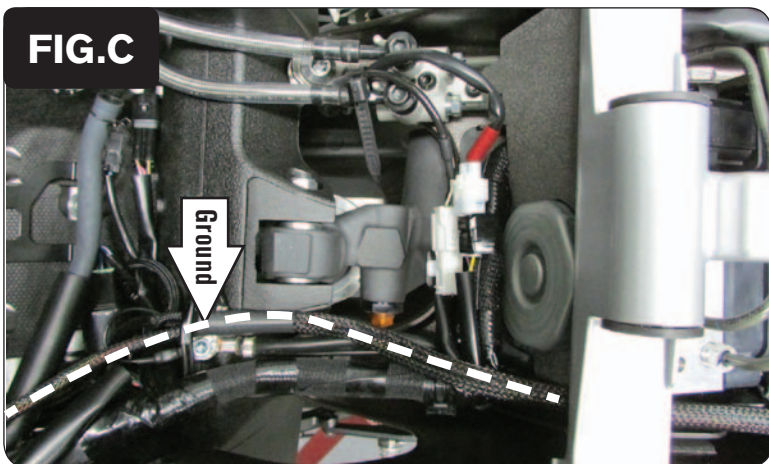
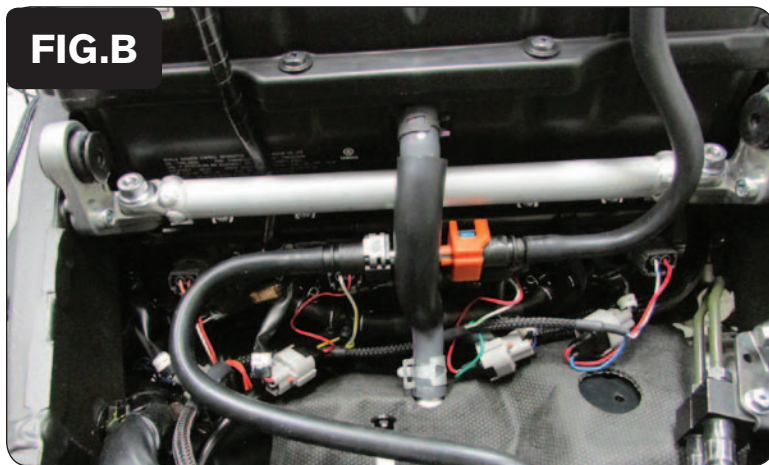
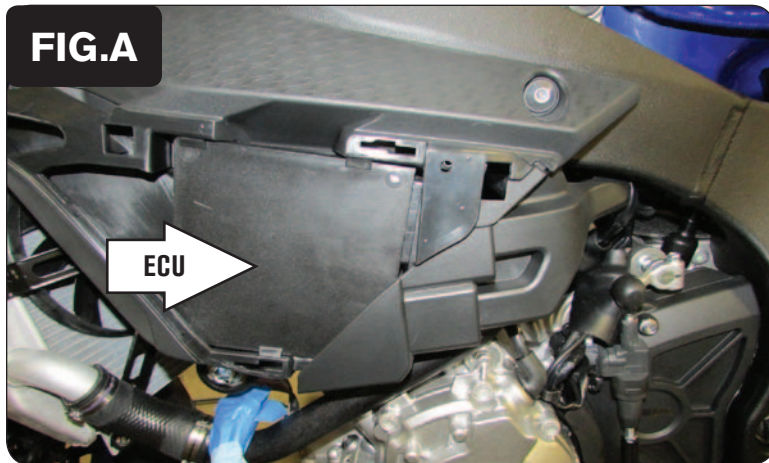

- 1 Remove the seat and the fuel tank.
- 2 Remove the left hand side cover and the cover over the ECU (Fig. A).
- 3 Lay the PCV in the tail section and route down the left side of the frame and go towards the throttle bodies. **Make sure to connect to the LOWER set of injectors.**
- 4 Plug the PCV in-line of the stock injectors and wiring harness (Fig. B).
PCV ORANGE colored wires go to cylinder #1
PCV YELLOW colored wires go to cylinder #2
PCV GREEN colored wires go to cylinder #3
PCV BLUE colored wires go to cylinder #4
- 5 Attach the ground wire of the PCV to the common ground location towards the rear of the engine (Fig. C).

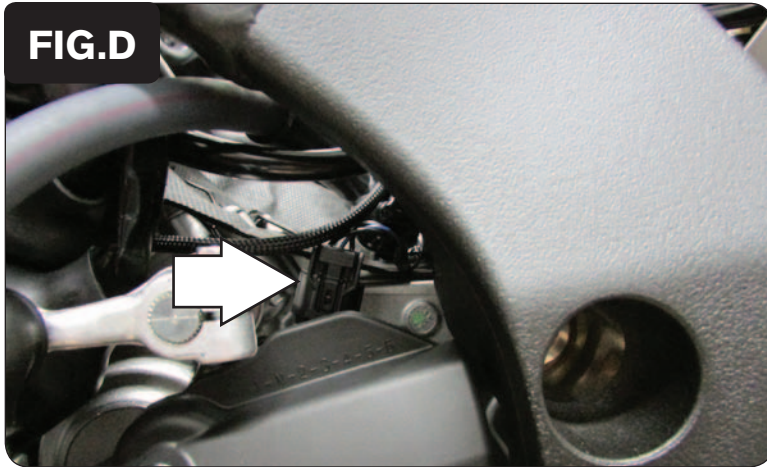

- 6 Plug the PCV in-line of the stock gear position sensor and wiring harness (Fig. D).

This connection is located on the left side of the engine above the sprocket cover.

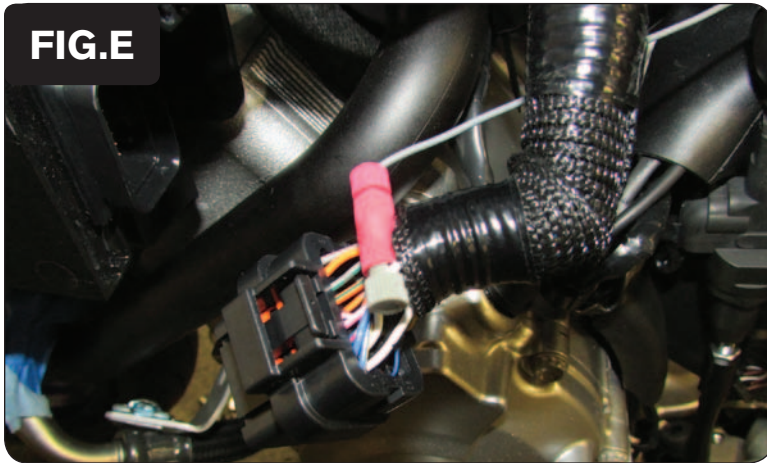

- 7 Unplug the small connector from the ECU. This will allow access to the harness. Pull the sheathing back

- 8 Use the supplied Posi-tap to attach the PCV GREY wire to the stock WHITE wire of the ECU (Fig. E).

There are 2 WHITE wires. Looking at the back of the connector go to pin #11.

- 9 Plug the connector back into the ECU.

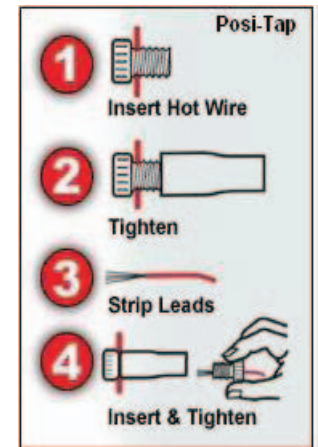

- 10 Unplug the crank position sensor connector (Fig. F).

This connection is located near the ECU. It is located inside a rubber boot that you will need to pull back to access

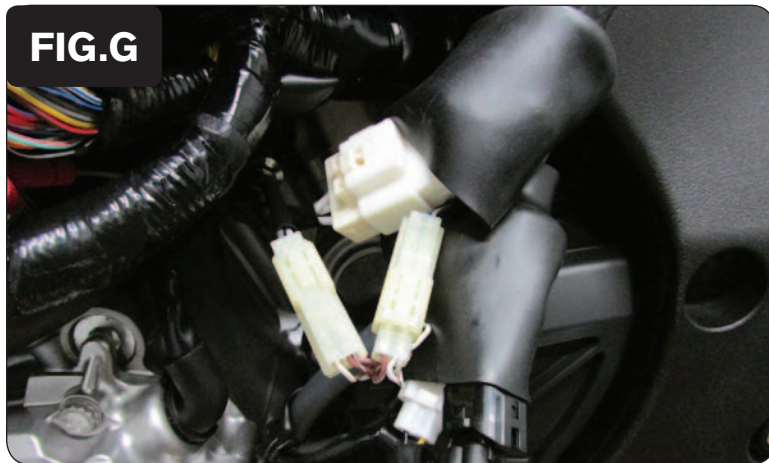

- 11 Plug the PCV wiring harness in-line of the CPS and the stock wiring harness (Fig. G).

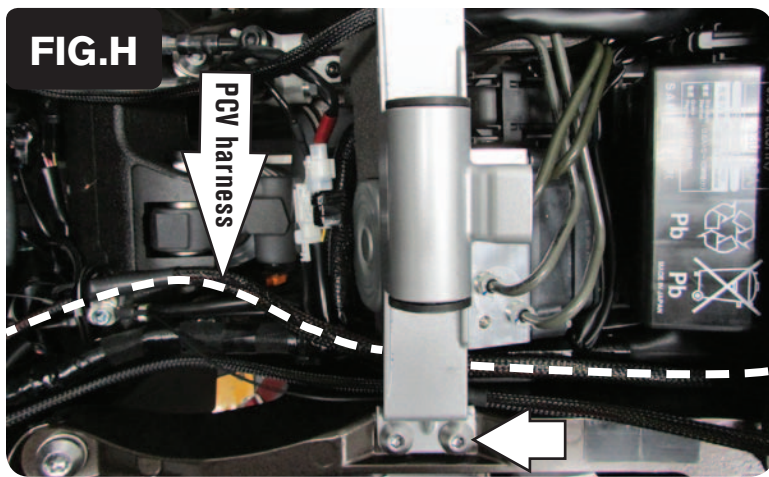

- 12 Remove the 4 bolts that hold the fuel tank bracket in place to allow the PCV harness to route underneath it (Fig. H).

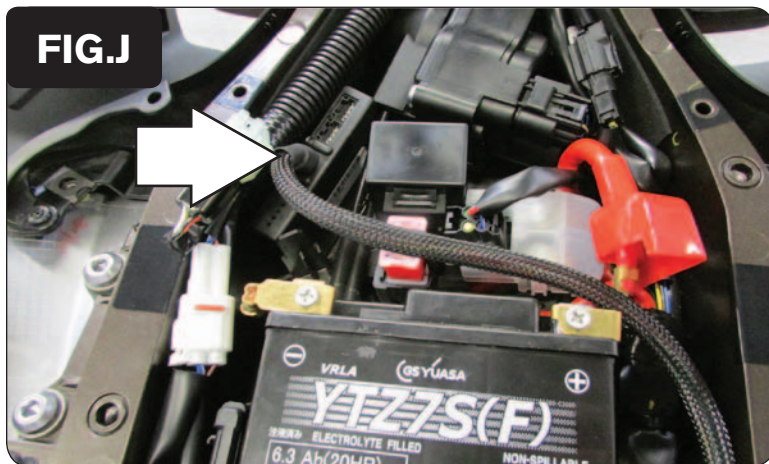

- 13 Install the PCV in the tail section of the motorcycle near the exhaust servo. The unit can also be installed on the right side of the battery if desired.
- 14 Reinstall the fuel tank, cover and seat.