

[POWER COMMANDER V]

2017-2018 BMW S1000R

Installation Instructions



PARTS LIST

- 1 Power Commander
- 1 USB Cable
- 1 Installation Guide
- 2 Power Commander Decals
- 2 Dynojet Decals
- 2 Velcro strips
- 1 Alcohol swab
- 2 Posi-taps

**THE IGNITION MUST BE TURNED
OFF BEFORE INSTALLATION!**

YOU CAN ALSO DOWNLOAD THE
POWER COMMANDER SOFTWARE AND
LATEST MAPS FROM OUR WEB SITE AT:
www.powercommander.com

PLEASE READ ALL DIRECTIONS BEFORE STARTING INSTALLATION

Dynojet

2191 Mendenhall Drive North Las Vegas, NV 89081 (800) 992-4993 www.powercommander.com

POWER COMMANDER V INPUT ACCESSORY GUIDE

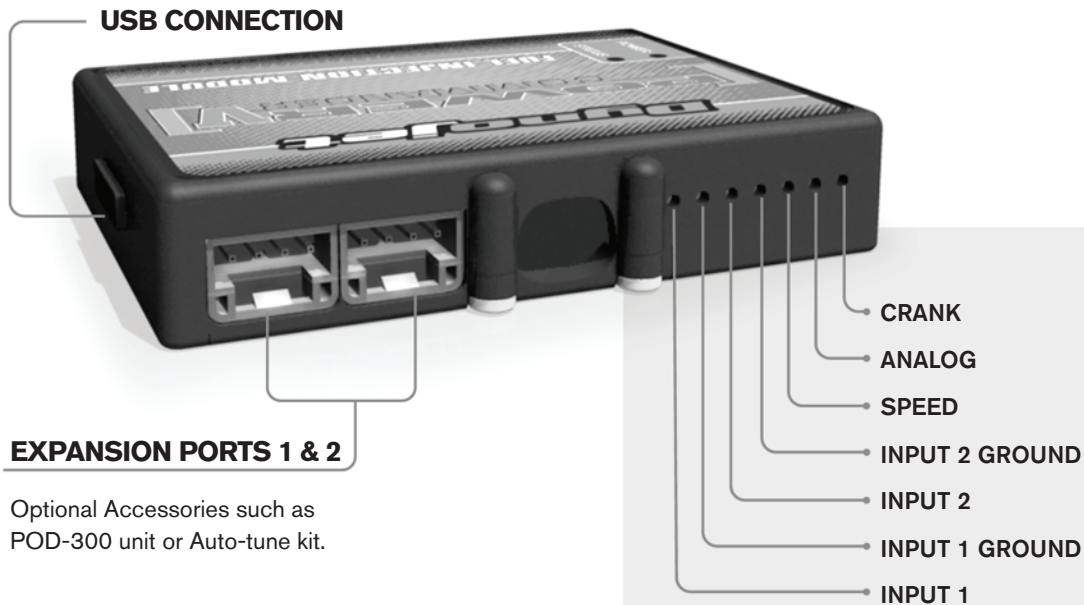

Wire connections:

To input wires into the PCV first remove the rubber plug on the backside of the unit and loosen the screw for the corresponding input. Using a 22-24 gauge wire strip about 10mm from its end. Push the wire into the hole of the PCV until it stops and then tighten the screw. Make sure to reinstall the rubber plug.

NOTE: If you tin the wires with solder it will make inserting them easier.

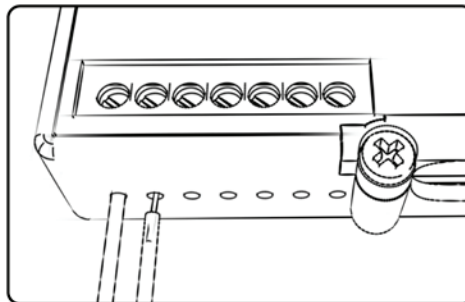

ACCESSORY INPUTS

Map -

(Input 1 or 2) The PCV has the ability to hold 2 different base maps. You can switch on the fly between these two base maps when you hook up a switch to the MAP inputs. You can use any open/close type switch. The polarity of the wires is not important. When using the Autotune kit one position will hold a base map and the other position will let you activate the learning mode. When the switch is "CLOSED" Autotune will be activated. (Set to Switch Input #1 by default.)

Shifter-

(Input 1 or 2) These inputs are for use with the Dynojet quickshifter. Insert the wires from the Dynojet quickshifter into the SHIFTER inputs. The polarity of the wires is not important. (Set to Switch Input #2 by default.)

Speed-

If your application has a speed sensor then you can tap into the signal side of the sensor and run a wire into this input. This will allow you to calculate gear position in the Control Center Software. Once gear position is setup you can alter your map based on gear position and setup gear dependent kill times when using a quickshifter.

Analog-

This input is for a 0-5v signal such as engine temp, boost, etc. Once this input is established you can alter your fuel curve based on this input in the control center software.

Crank-

Do **NOT** connect anything to this port unless instructed to do so by Dynojet. It is used to transfer crank trigger data from one module to another.



- 1 Remove the seat.
- 2 Remove the fuel tank covers (Fig. A).
- 3 Remove the fuel tank or prop it up out of the way.
- 4 Remove the left and right side fairings.



- 5 Install the PCV in the tail section using the supplied Velcro (Fig. B).
Make sure to use the alcohol swab to clean both surfaces before attaching.

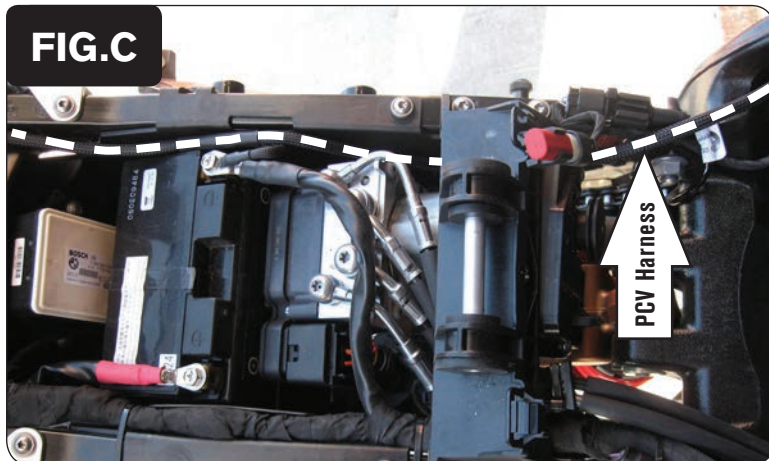

- 6 Route the PCV harness down the left side of the bike. Route the harness underneath the fuel tank bracket and go towards the throttle bodies (Fig. C).

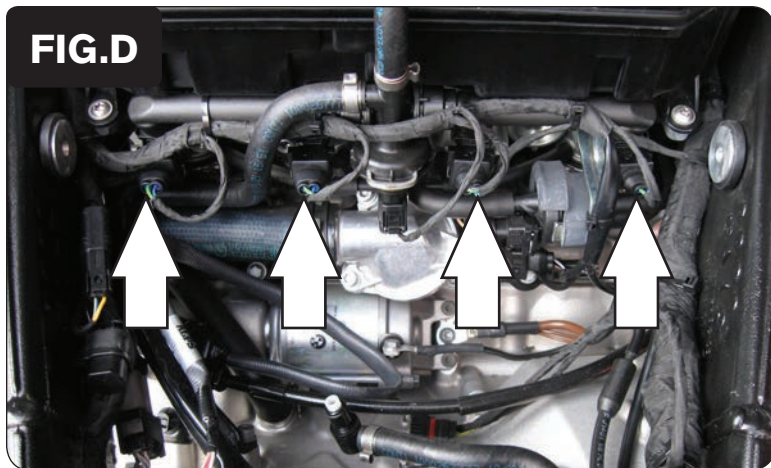

7 Unplug the stock wiring harness from each lower primary fuel injector (Fig. D).



8 Plug the PCV harness in-line of the stock wiring harness and fuel injectors (Fig.E).

PCV harness:

ORANGE - cylinder #1

YELLOW - cylinder #2

GREEN - cylinder #3

BLUE - cylinder #4

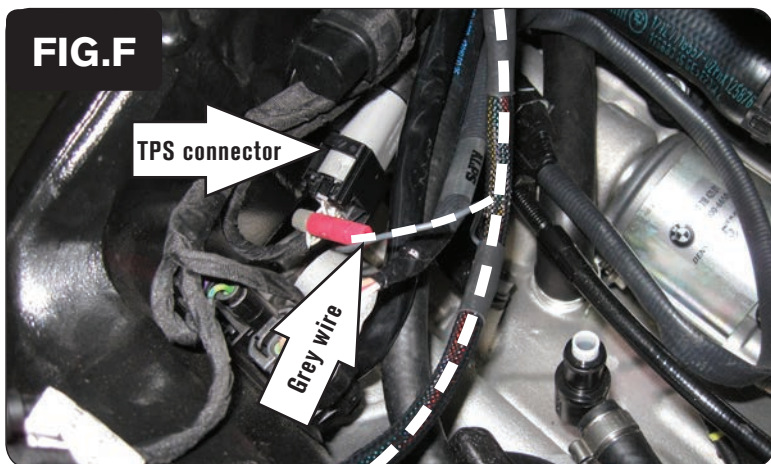

9 Locate the Throttle Position Sensor connector from the throttle blade on the left, inside of the frame (Fig. F).

10 Attach the GREY wire of the PCV to the WHITE/GREY wire of the TPS connector (Fig. F).

It is recommended to use dielectric grease on these connections.

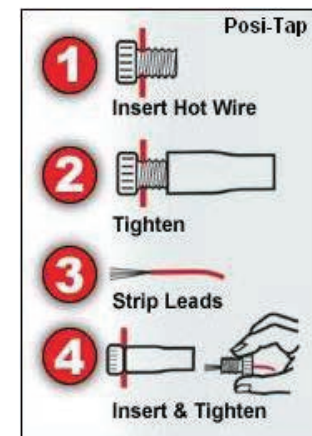



- 11 Using the supplied Posi-Tap connect the BLUE wire of the PCV to the PURPLE/BLACK wire of the gear position sensor connector (Fig. G).

This connector is located under the fuel tank to the left, rear of the frame.

There are 2 PURPLE/BLACK wires on this connector. Use the one in the middle.

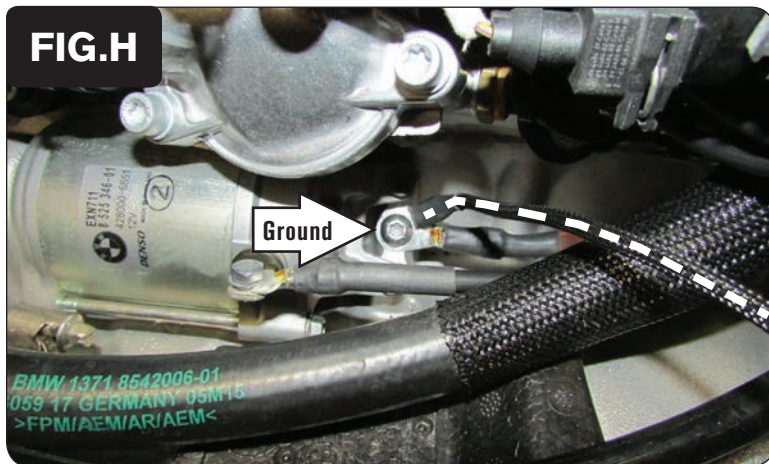
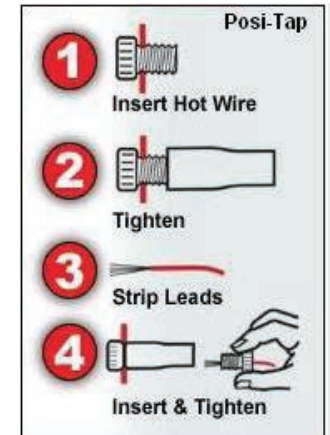

- 12 Secure the PCV ground wire with the small ring lug to the stock common ground bolt on the engine case just rear of the starter (Fig. H).
- 13 Reinstall the fuel tank and bodywork.