

[POWER COMMANDER V]

2009-2011 Yamaha R1

Installation Instructions



PARTS LIST

- 1 Power Commander
- 1 USB Cable
- 1 Installation Guide
- 2 Power Commander Decals
- 2 Dynojet Decals
- 2 Velcro strips
- 1 Dual Lock strip
- 1 Alcohol swab
- 1 Posi-tap
- 1 O2 Optimizer
- 3 Zip ties

THE IGNITION MUST BE TURNED OFF BEFORE INSTALLATION!

THE LATEST POWER COMMANDER SOFTWARE AND MAP FILES CAN BE DOWNLOADED FROM OUR WEB SITE AT:
www.powercommander.com

PLEASE READ ALL DIRECTIONS BEFORE STARTING INSTALLATION

Dynojet

2191 Mendenhall Drive North Las Vegas, NV 89081 (800) 992-4993 www.powercommander.com

POWER COMMANDER V INPUT ACCESSORY GUIDE

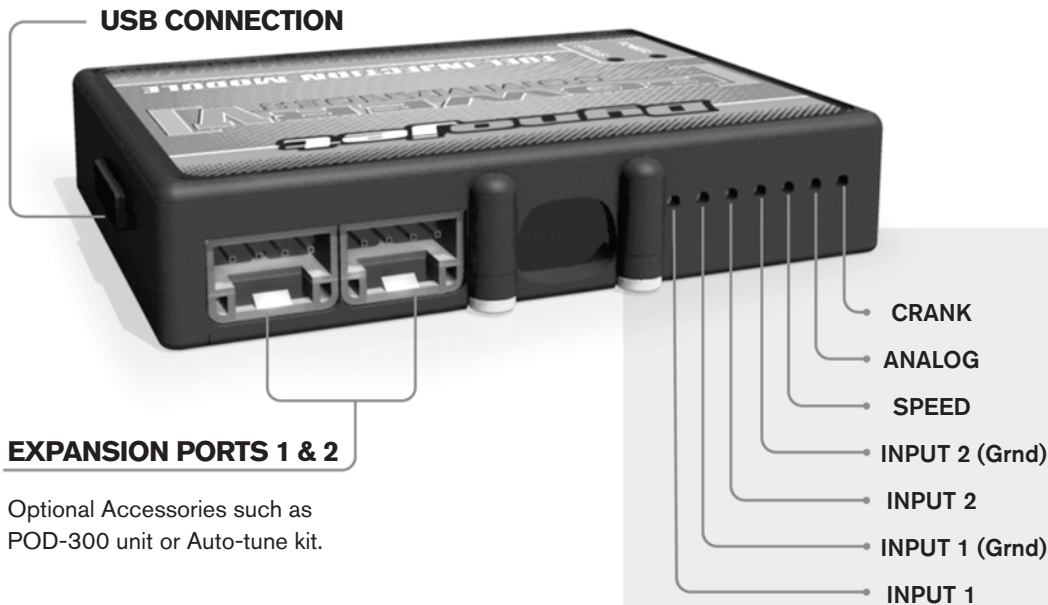

Optional Accessories such as
POD-300 unit or Auto-tune kit.

Wire connections:

To input wires into the PCV first remove the rubber plug on the backside of the unit and loosen the screw for the corresponding input. Using a 22-24 gauge wire strip about 10mm from its end. Push the wire into the hole of the PCV until it stops and then tighten the screw. Make sure to reinstall the rubber plug.

NOTE: If you tin the wires with solder it will make inserting them easier.

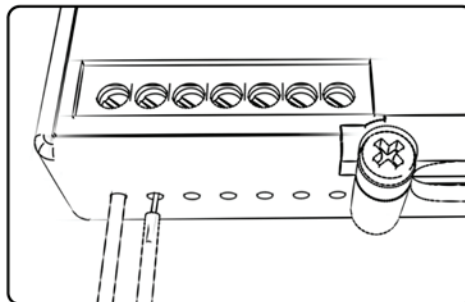

ACCESSORY INPUTS

Map -

(Input 1 or 2) The PCV has the ability to hold 2 different base maps. You can switch on the fly between these two base maps when you hook up a switch to the MAP inputs. You can use any open/close type switch. The polarity of the wires is not important. When using the Autotune kit one position will hold a base map and the other position will let you activate the learning mode. When the switch is "CLOSED" Autotune will be activated. (Set to Switch Input #1 by default.)

Shifter-

(Input 1 or 2) These inputs are for use with the Dynojet quickshifter. Insert the wires from the Dynojet quickshifter into the SHIFTER inputs. The polarity of the wires is not important. (Set to Switch Input #2 by default.)

Speed-

If your application has a speed sensor then you can tap into the signal side of the sensor and run a wire into this input. This will allow you to calculate gear position in the Control Center Software. Once gear position is setup you can alter your map based on gear position and setup gear dependent kill times when using a quickshifter.

Analog-

This input is for a 0-5v signal such as engine temp, boost, etc. Once this input is established you can alter your fuel curve based on this input in the control center software.

Crank-

Do **NOT** connect anything to this port unless instructed to do so by Dynojet. It is used to transfer crank trigger data from one module to another.

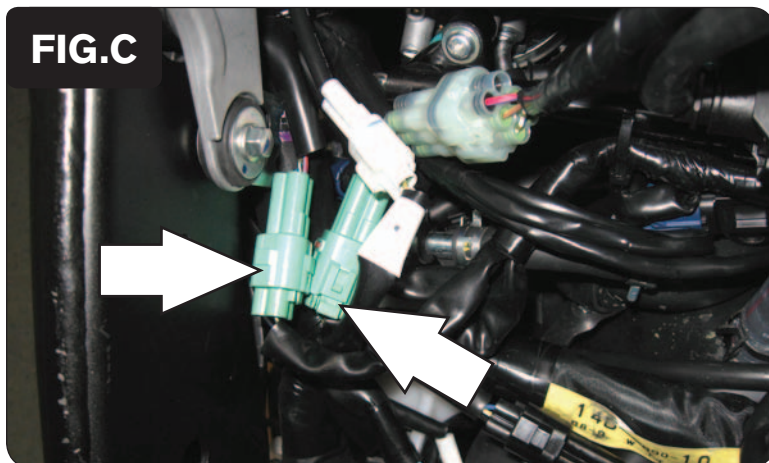
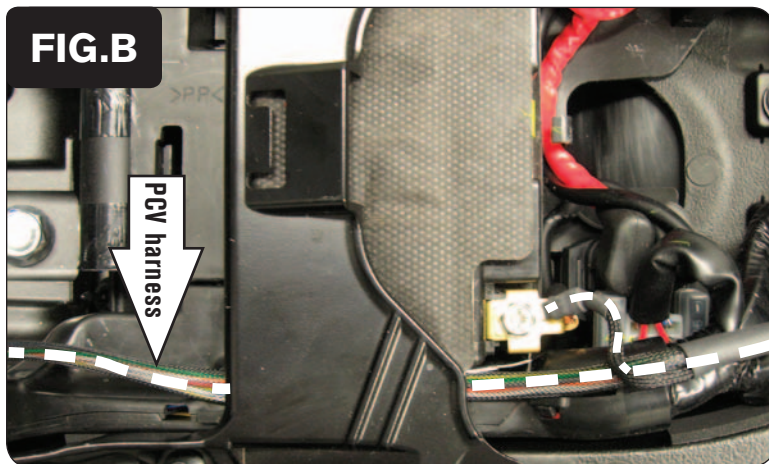
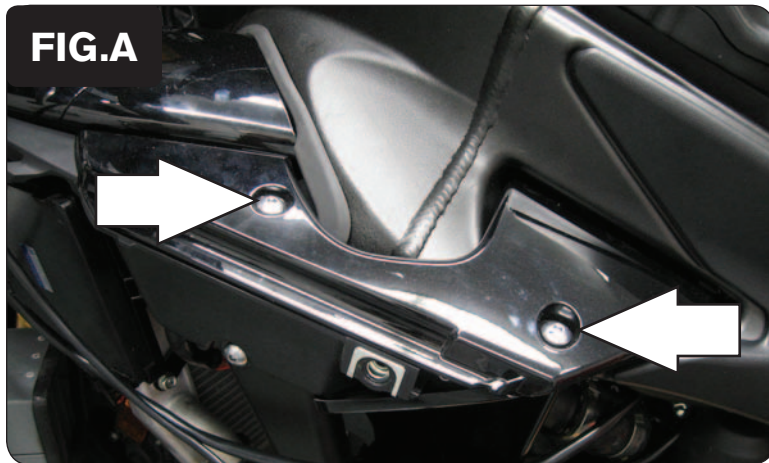

- 1 Remove the main seat.
- 2 Lift the front of the fuel tank up and use something to keep it propped up.
- 3 Remove the inner fairing on the left hand side of the bike (Fig. A).
- 4 Lay the PCV near the battery and route the harness down the left side of the bike. Route the harness underneath the battery bracket (Fig. B).
- 5 Attach the ground wire of the PCV to the negative side of the battery
- 6 Unplug the connectors from the throttle bodies to the main wiring harness (Fig. C).

There is a GREEN 3 pin connector and a GREEN 4 pin connector to the inside of the frame on the left side.



- 7 Plug the PCV harness in-line of the stock wiring harness and throttle bodies (Fig. D).

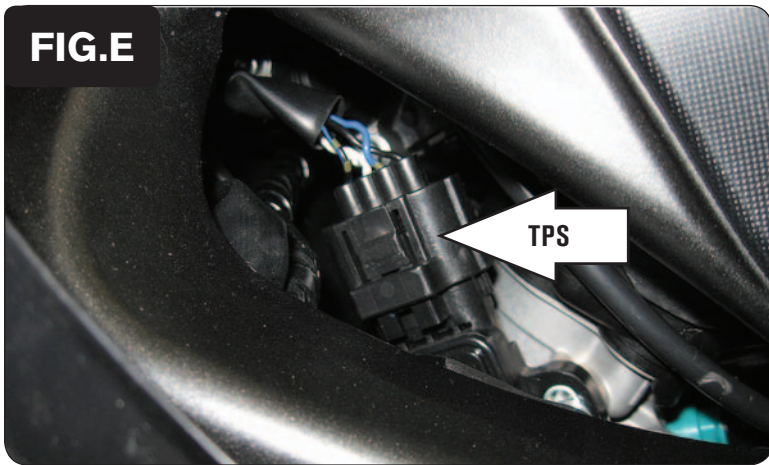

- 8 Unplug the wiring harness from the Throttle Position Sensor (Fig. E).
This connector is located on the left side of the throttle bodies underneath the inner fairing that was removed in step 3.

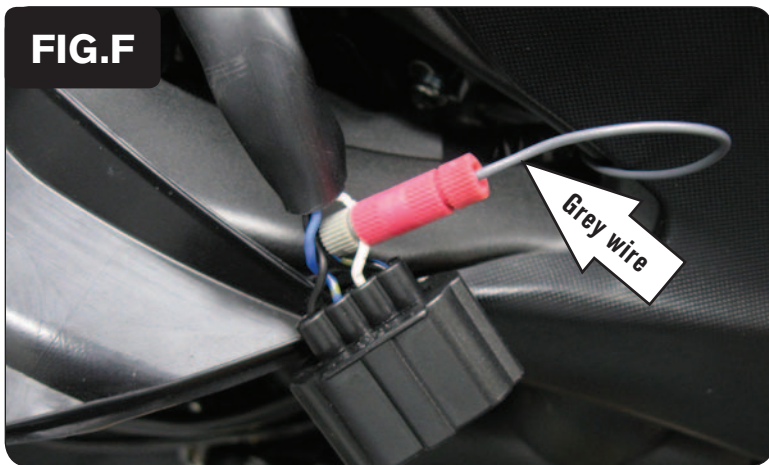

- 9 Using the supplied Posi-tap attach the GREY wire of the PCV to the WHITE wire of the TPS harness (Fig. F).
- 10 Plug the TPS back on to the throttle bodies

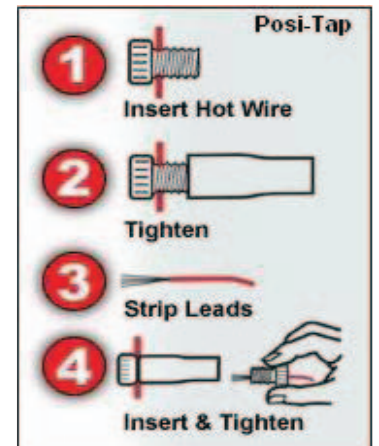

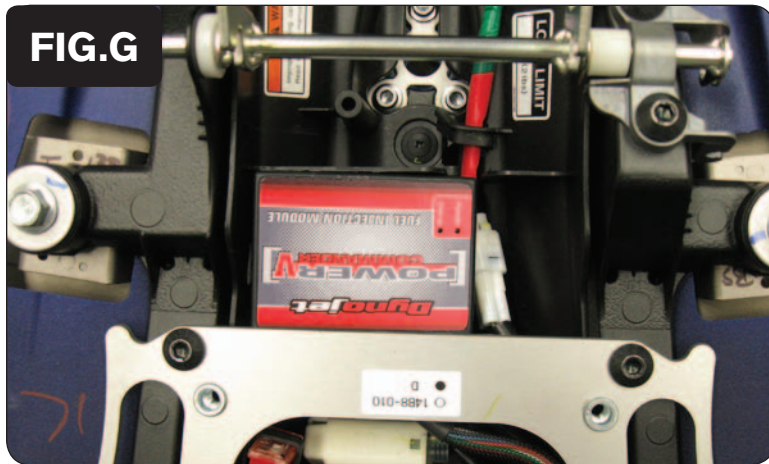

- 11 Install the PCV in the tail section using the supplied Velcro, if needed (Fig. G).

Use the supplied alcohol swab to clean the surface prior to applying the Velcro.

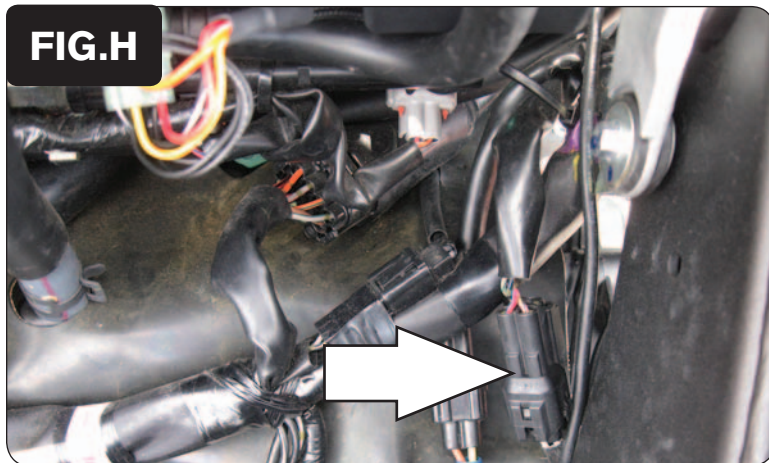

- 12 Locate the stock O2 sensor connection.

This is located under the fuel tank near the right hand side of the frame. It is a BLACK 4 pin connector.

- 13 Unplug the stock O2 sensor from the main wiring harness (Fig. H).

- 14 Plug the Dynojet O2 Optimizer in-line of the stock wiring harness and O2 sensor (Fig. J).

- 15 Using the supplied Velcro attach the optimizer to the back side of the air box.

- 16 Reinstall fuel tank back into place and bodywork.

Optional Inputs:

Speed input location - Top of engine case on left hand side. PINK wire on sensor side - WHITE/YELLOW wire on ECU side.

Temperature input location - Temperature sensor is located on back of cylinder near #3 throttle body. GREEN/WHITE wire to ECU. Pin #34 on small ECU connector

12v for Autotune - BLUE/RED wire of tail light connector.

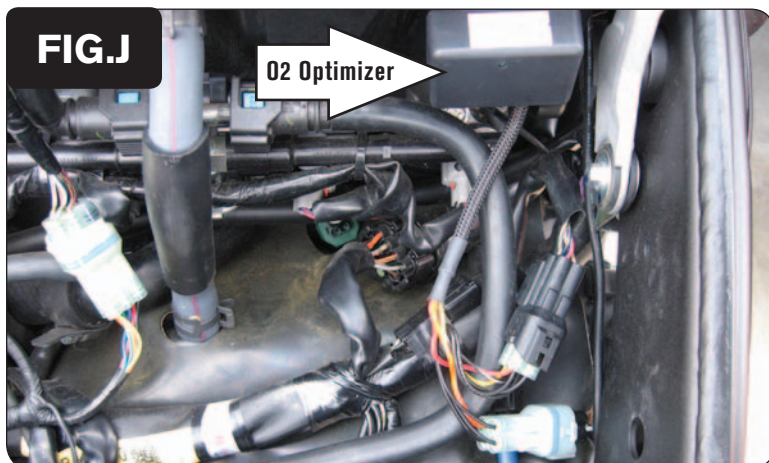

	0	2	5	10	15	20	40	60	80	100
500	0	0	0	0	0	0	0	0	0	0
750	0	0	0	0	0	0	0	0	0	0
1000	0	0	0	0	0	0	0	0	0	0
1250	0	0	0	0	0	0	0	0	0	0
1500	0	0	0	0	0	0	0	0	0	0
1750	0	0	0	0	0	0	0	0	0	0
2000	0	0	0	0	0	0	0	0	0	0
2250	0	0	0	0	0	0	0	0	0	0
2500	0	0	0	0	0	0	0	0	0	0
2750	0	0	0	0	0	0	0	0	0	0
3000	0	0	0	0	0	0	0	0	0	0
3250	0	0	0	0	0	0	0	0	0	0
3500	0	0	0	0	0	0	0	0	0	0
3750	0	0	0	0	0	0	0	0	0	0
4000	0	0	0	0	0	0	0	0	0	0
4250	0	0	0	0	0	0	0	0	0	0
4500	0	0	0	0	0	0	0	0	0	0
4750	0	0	0	0	0	0	0	0	0	0
5000	0	0	0	0	0	0	0	0	0	0
5250	0	0	0	0	0	0	0	0	0	0
5500	0	0	0	0	0	0	0	0	0	0
5750	0	0	0	0	0	0	0	0	0	0
6000	0	0	0	0	0	0	0	0	0	0
6250	0	0	0	0	0	0	0	0	0	0
6500	0	0	0	0	0	0	0	0	0	0
6750	0	0	0	0	0	0	0	0	0	0
7000	0	0	0	0	0	0	0	0	0	0
7250	0	0	0	0	0	0	0	0	0	0
7500	0	0	0	0	0	0	0	0	0	0

FIG.K

Tuning Notes:

This bike uses a fly-by wire system, so conventional tuning can not be performed for all RPM and throttle ranges.

The GREY wire from the PCV is attached to the throttle blade angle sensor of the throttle bodies which is NOT directly correlated to the throttle grip position. Because of this when setting the throttle position in the PCV software we recommend on resetting only the closed position after the bike has completely warmed up. Use the arrow key (<) next to CLOSED to perform this step and then click OK. Do not try to set the OPEN position unless you are on a dyno and above 11000rpm.

You will notice that in the maps there are not detailed values below 10500rpm at 60-100%. This is because the throttle blades will not open more than 60% below this RPM range no matter how much throttle input is given. Therefore this area can not be tuned.

The O2 Optimizer for this model controls the stock closed loop area. This area is represented by the highlighted cells shown in Figure K. The optimizer is designed to achieve a target AFR of 13.6:1. To use this optimizer you must retain your stock O2 sensor (even if using Auto-tune).

It is not necessary to input values in the highlighted area. If using the Auto tune system do NOT input values in this area in your Target AFR table.

The Optimizer will blink while the sensor is being heated up. The units are not functioning until the light is lit up solid.