

[POWER COMMANDER V]

2011-2014 Yamaha XTZ1200

Installation Instructions



PARTS LIST

- 1 Power Commander
- 1 USB Cable
- 1 Installation Guide
- 2 Power Commander Decals
- 2 Dynojet Decals
- 4 Velcro strips
- 1 Alcohol swab
- 1 O2 Optimizer
- 1 Posi-tap

**THE IGNITION MUST BE TURNED
OFF BEFORE INSTALLATION!**

THE LATEST POWER COMMANDER
SOFTWARE AND MAP FILES CAN BE
DOWNLOADED FROM OUR WEB SITE AT:
www.powercommander.com

PLEASE READ ALL DIRECTIONS BEFORE STARTING INSTALLATION

Dynojet

2191 Mendenhall Drive North Las Vegas, NV 89081 (800) 992-4993 www.powercommander.com

POWER COMMANDER V INPUT ACCESSORY GUIDE

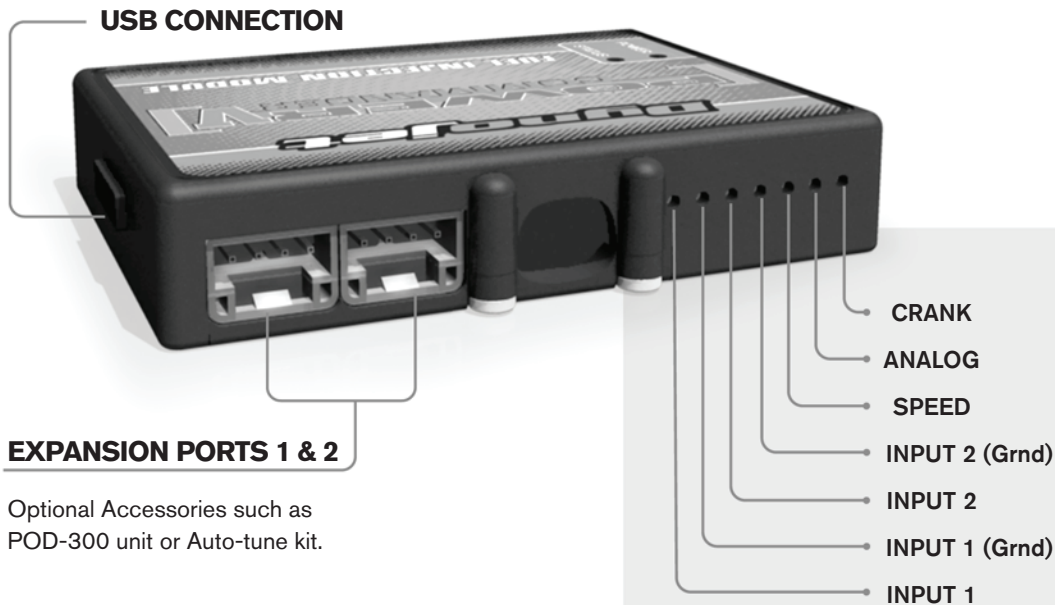

Optional Accessories such as POD-300 unit or Auto-tune kit.

Wire connections:

To input wires into the PCV first remove the rubber plug on the backside of the unit and loosen the screw for the corresponding input. Using a 22-24 gauge wire strip about 10mm from its end. Push the wire into the hole of the PCV until it stops and then tighten the screw. Make sure to reinstall the rubber plug.

NOTE: If you tin the wires with solder it will make inserting them easier.

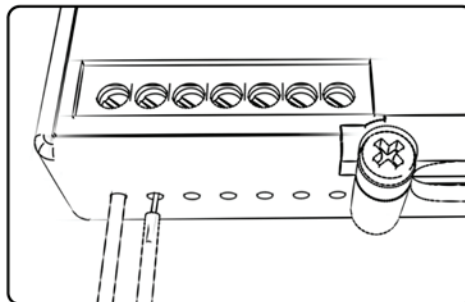

ACCESSORY INPUTS

Map -

(Input 1 or 2) The PCV has the ability to hold 2 different base maps. You can switch on the fly between these two base maps when you hook up a switch to the MAP inputs. You can use any open/close type switch. The polarity of the wires is not important. When using the Autotune kit one position will hold a base map and the other position will let you activate the learning mode. When the switch is "CLOSED" Autotune will be activated. (Set to Switch Input #1 by default.)

Shifter-

(Input 1 or 2) These inputs are for use with the Dynojet quickshifter. Insert the wires from the Dynojet quickshifter into the SHIFTER inputs. The polarity of the wires is not important. (Set to Switch Input #2 by default.)

Speed-

If your application has a speed sensor then you can tap into the signal side of the sensor and run a wire into this input. This will allow you to calculate gear position in the Control Center Software. Once gear position is setup you can alter your map based on gear position and setup gear dependent kill times when using a quickshifter.

Analog-

This input is for a 0-5v signal such as engine temp, boost, etc. Once this input is established you can alter your fuel curve based on this input in the control center software.

Crank-

Do **NOT** connect anything to this port unless instructed to do so by Dynojet. It is used to transfer crank trigger data from one module to another.

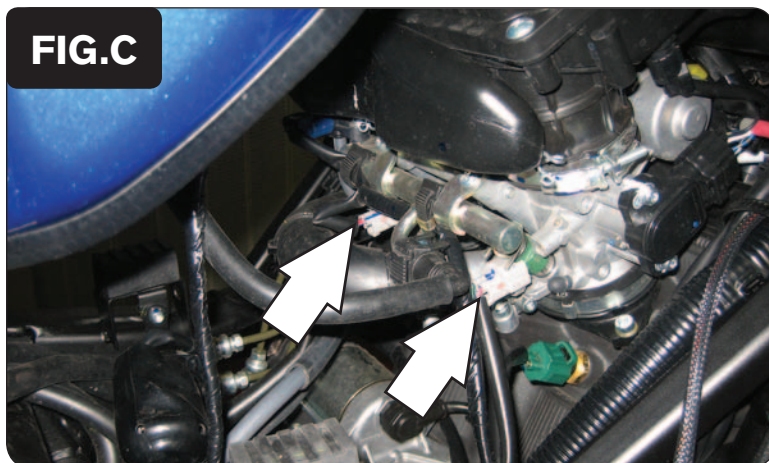
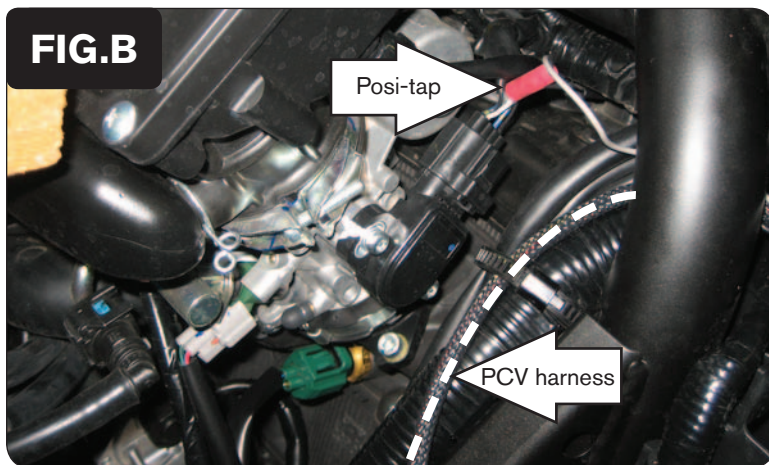
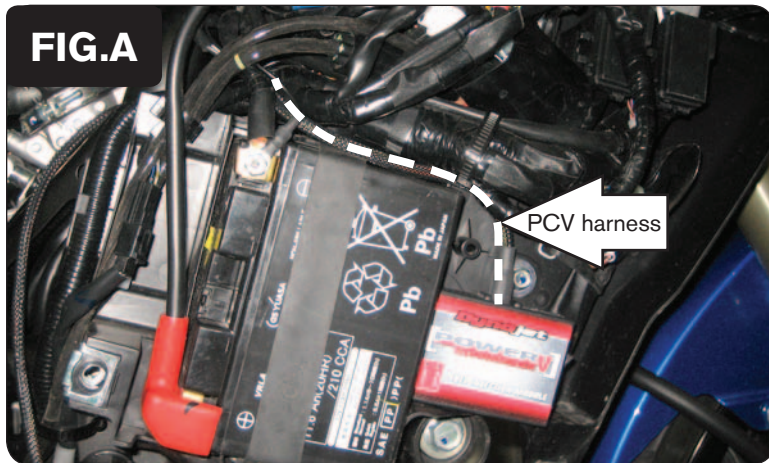

- 1 Remove the seat.
- 2 Remove both Left and Right side panels.
- 3 Prop the front of the fuel tank up.
- 4 Place the PCV on the right side of the bike near the battery (Fig. A).
- 5 Connect the PCV ground wire to the negative side of the battery (Fig. A).

Use the stock zip tie to secure the PCV harness to the main harness.

- 6 Route the PCV harness along the stock main harness, under the frame tube and to the throttle body (Fig. B).
- 7 Locate the Throttle Position sensor (Fig. B) This connector is located on the right side of the throttle bodies.
- 8 Using the supplied Posi-tap connect the GREY wire of the PCV to the stock WHITE wire (Fig. B).
- 9 Use stock zip tie to secure the PCV harness to the main harness

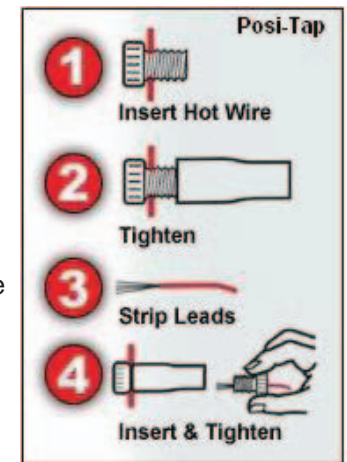

- 10 Unplug the stock wiring harness from each injector (Fig. C).



FIG.D

- 11 Plug the PCV harness in-line of the stock wiring harness and each injector (Fig. D).

PCV ORANGE wires go to cylinder #1 (left).

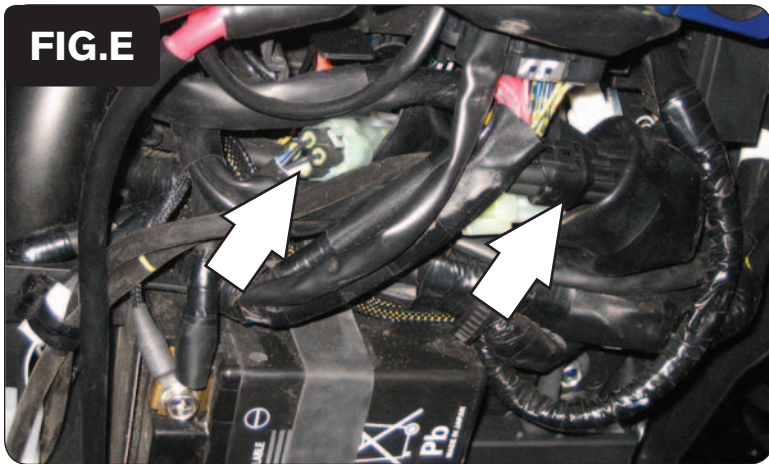

FIG.E

- 12 Locate the stock O2 sensor connections. They are on top of the battery and are hidden inside the black rubber boots (Fig. E).

The CLEAR connector is for the RIGHT O2 sensor. The BLACK connector is for the LEFT O2 sensor.

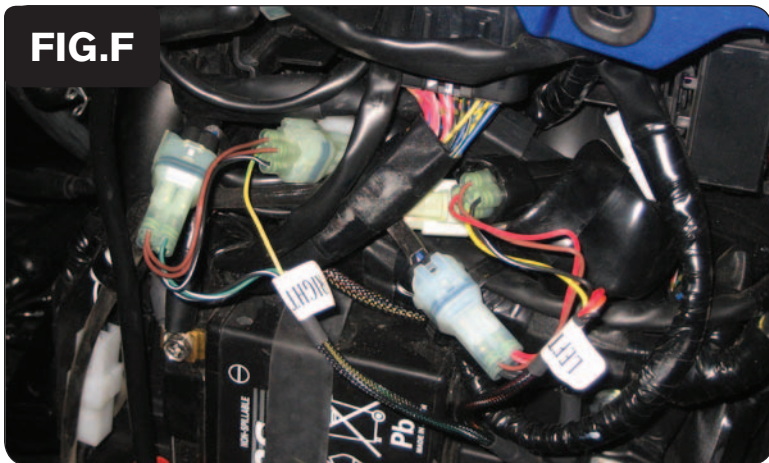
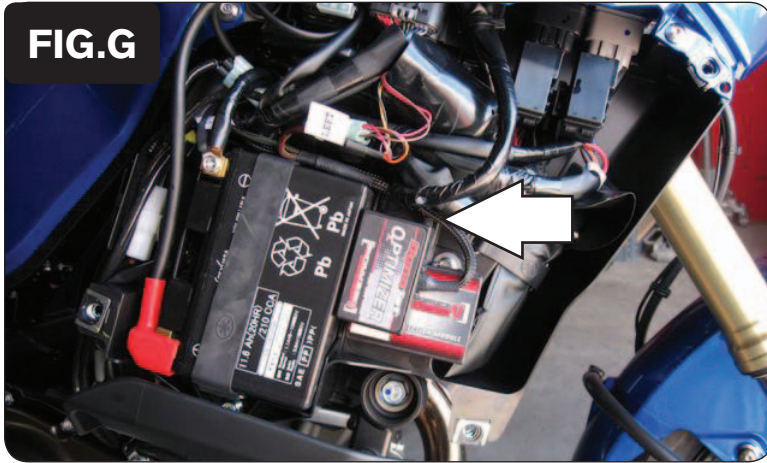

FIG.F

- 13 Plug the O2 Optimizers in-line of the stock O2 sensor connections (Fig. F).

Optimizer connector labeled LEFT connect to the front connection (stock BLACK connector)

Optimizer connector labeled RIGHT connect to the rear connection (stock CLEAR connector)

FIG.G

- Using the supplied Velcro, secure the O2 Optimizer and the PCV module in the tail next to the battery (Fig. G).

Clean all surfaces with the supplied alcohol swab prior to applying the Velcro.

- Reinstall tank, seat and side panels.

FIG.H

		% Farfalla									
		0	2	5	10	15	20	40	60	80	100
rpm	500	0	0	0	0	0	0	0	0	0	0
	750	0	0	0	0	0	0	0	0	0	0
	1000	0	0	0	0	0	0	0	0	0	0
	1250	0	0	0	0	0	0	0	0	0	0
	1500	0	0	0	0	0	0	0	0	0	0
	1750	0	0	0	0	0	0	0	0	0	0
	2000	0	0	0	0	0	0	0	0	0	0
	2250	0	0	0	0	0	0	0	0	0	0
	2500	0	0	0	0	0	0	0	0	0	0
	2750	0	0	0	0	0	0	0	0	0	0
	3000	0	0	0	0	0	0	0	0	0	0
	3250	0	0	0	0	0	0	0	0	0	0
	3500	0	0	0	0	0	0	0	0	0	0
	3750	0	0	0	0	0	0	0	0	0	0
	4000	0	0	0	0	0	0	0	0	0	0
	4250	0	0	0	0	0	0	0	0	0	0
	4500	0	0	0	0	0	0	0	0	0	0
	4750	0	0	0	0	0	0	0	0	0	0
5000	0	0	0	0	0	0	0	0	0	0	
5250	0	0	0	0	0	0	0	0	0	0	
5500	0	0	0	0	0	0	0	0	0	0	
5750	0	0	0	0	0	0	0	0	0	0	

Tuning notes:

The O2 Optimizer for this model controls the stock closed loop area. This area is represented by the highlighted cells shown in Figure H. The O2 Optimizer is designed to achieve a target AFR of 13.6:1. To use this O2 Optimizer you must retain your stock O2 sensors (even if using Auto-tune).

It is not necessary to alter the values in the highlighted area of your fuel table. If using the Auto-tune system do NOT input values in this area of your Target AFR table.