

[POWER COMMANDER V]

2015 Yamaha FJ-09

Installation Instructions



PARTS LIST

- 1 Power Commander
- 1 USB Cable
- 1 Installation Guide
- 2 Power Commander Decals
- 2 Dynojet Decals
- 3 Velcro strips
- 1 Alcohol swab
- 1 Posi-tap
- 1 O2 Optimizer

THE IGNITION MUST BE TURNED OFF BEFORE INSTALLATION!

THE LATEST POWER COMMANDER SOFTWARE AND MAP FILES CAN BE DOWNLOADED FROM OUR WEB SITE AT:
www.powercommander.com

PLEASE READ ALL DIRECTIONS BEFORE STARTING INSTALLATION

Dynojet

2191 Mendenhall Drive North Las Vegas, NV 89081 (800) 992-4993 www.powercommander.com

POWER COMMANDER V INPUT ACCESSORY GUIDE

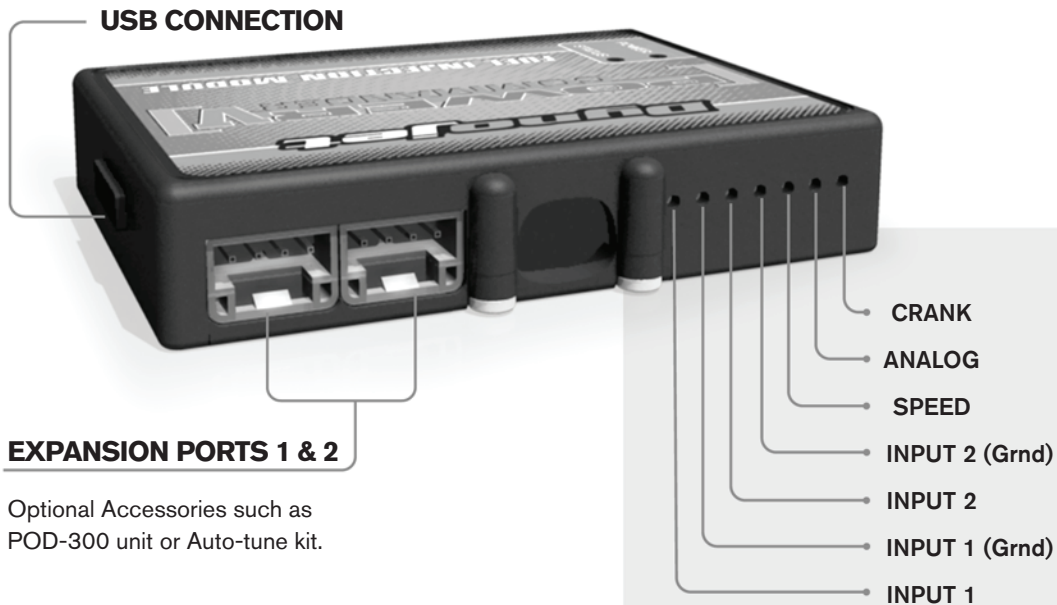

Wire connections:

To input wires into the PCV first remove the rubber plug on the backside of the unit and loosen the screw for the corresponding input. Using a 22-24 gauge wire strip about 10mm from its end. Push the wire into the hole of the PCV until it stops and then tighten the screw. Make sure to reinstall the rubber plug.

NOTE: If you tin the wires with solder it will make inserting them easier.

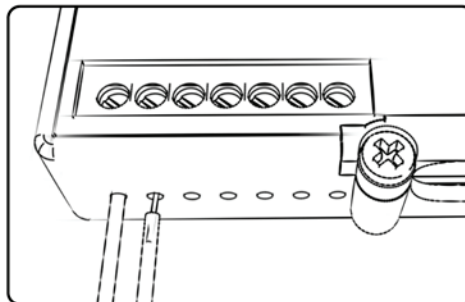

ACCESSORY INPUTS

Map -

(Input 1 or 2) The PCV has the ability to hold 2 different base maps. You can switch on the fly between these two base maps when you hook up a switch to the MAP inputs. You can use any open/close type switch. The polarity of the wires is not important. When using the Autotune kit one position will hold a base map and the other position will let you activate the learning mode. When the switch is "CLOSED" Autotune will be activated. (Set to Switch Input #1 by default.)

Shifter-

(Input 1 or 2) These inputs are for use with the Dynojet quickshifter. Insert the wires from the Dynojet quickshifter into the SHIFTER inputs. The polarity of the wires is not important. (Set to Switch Input #2 by default.)

Speed-

If your application has a speed sensor then you can tap into the signal side of the sensor and run a wire into this input. This will allow you to calculate gear position in the Control Center Software. Once gear position is setup you can alter your map based on gear position and setup gear dependent kill times when using a quickshifter.

Analog-

This input is for a 0-5v signal such as engine temp, boost, etc. Once this input is established you can alter your fuel curve based on this input in the control center software.

Crank-

Do **NOT** connect anything to this port unless instructed to do so by Dynojet. It is used to transfer crank trigger data from one module to another.



- 1 Remove the seat.
- 2 Remove the fuel tank.
- 3 Unplug the ECM.
- 4 Remove the air box (Fig. A).

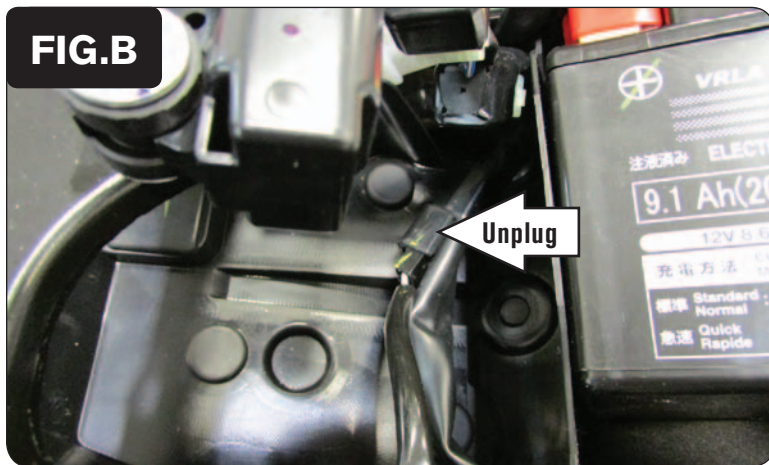

- 5 Locate and unplug the stock Crank Position Sensor connectors (Fig B).
This is a pair of BLACK 2-pin connectors just forward of the battery.

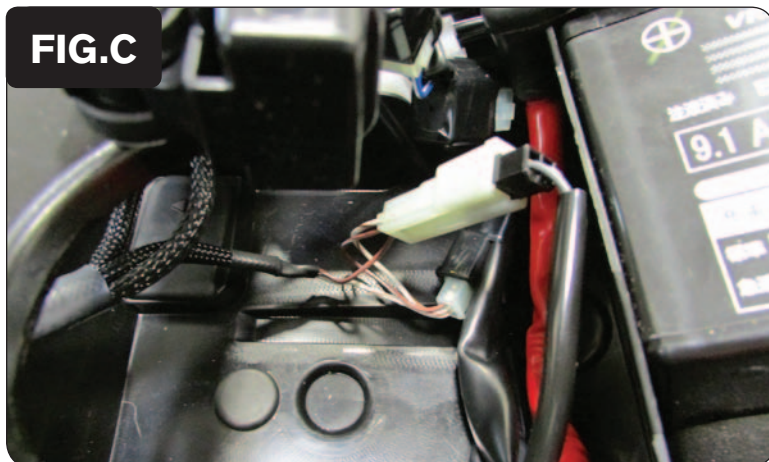

- 6 Plug the pair of PCV connectors with BROWN colored wires in-line of the stock Crank Position Sensor connectors (Fig. C).

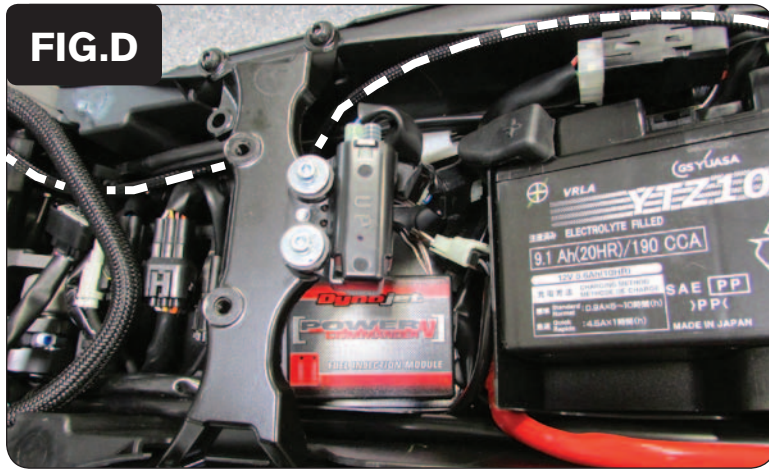

- 7 Using one of the supplied Velcro strips, secure the PCV module in front of the battery (Fig. D).

Use the supplied alcohol swab to clean the surface area prior to applying the Velcro.

- 8 Route the PCV's ground cable with the ring lug towards the negative (-) terminal of the bike's battery. Route the rest of the wiring harness forward towards the engine beneath the frame crossover bracket and follow inside the right side frame rail.

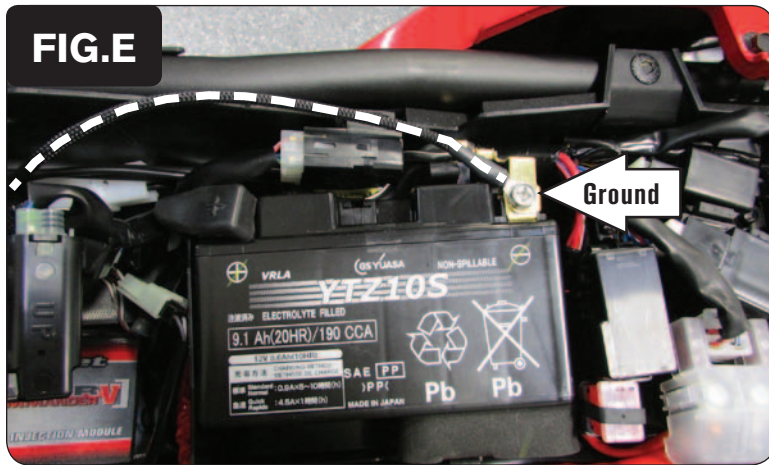

- 9 Secure the PCV ground wire with the ring lug to the negative (-) terminal of the bike's battery (Fig. E).

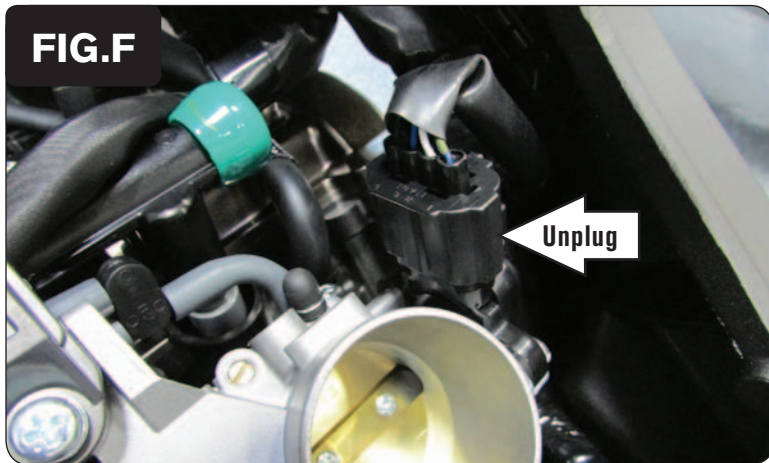

- 10 Unplug the stock Throttle Position Sensor connector (Fig. F).

This is a BLACK 4-pin connector on the right side of the throttle bodies.

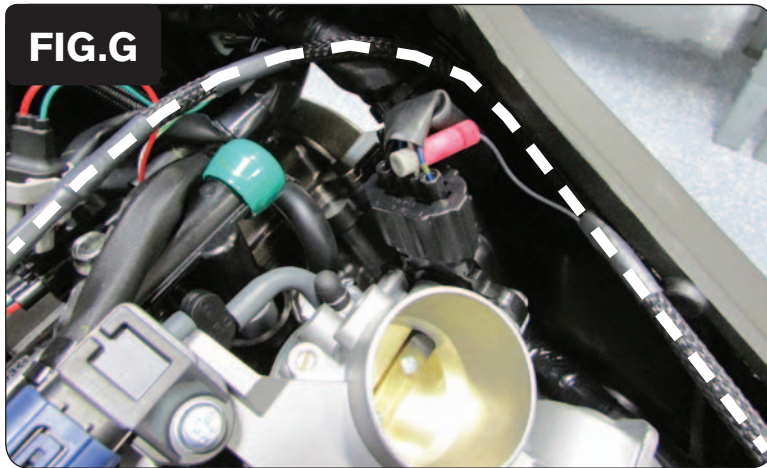

- 11 Use the supplied Posi-tap to attach the PCV's GREY wire to the stock WHITE wire of the bike's TPS. Reconnect the stock wiring harness to the TPS after attaching the GREY wire.
- 12 Continue routing the PCV wiring harness across the top of the fuel rail (Fig. G).

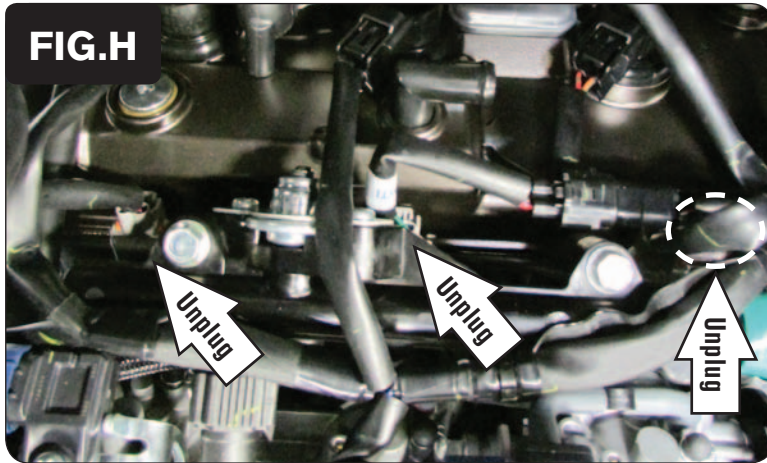
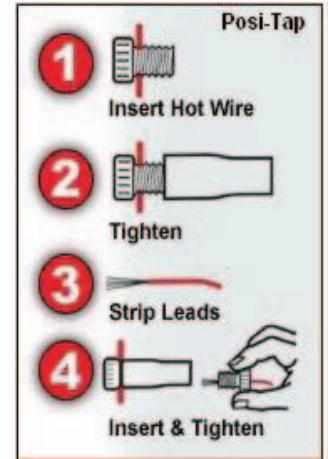

- 13 Unplug the stock wiring harness from all three of the bike's Fuel Injectors (Fig. H).

The cylinder #3 (right-most) injector cannot be seen from this picture. It is in the vicinity of the dashed circle.

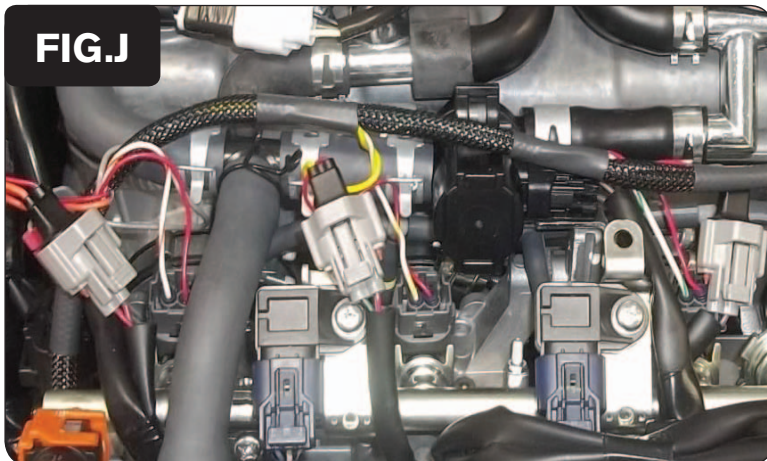

- 14 Plug the PCV wiring harness in-line of each Fuel Injector and the stock wiring harness (Fig. J).

The pair of PCV leads with GREEN colored wires go in-line of the cylinder #3 (right-most) Fuel Injector and the stock wiring harness.

The pair of PCV leads with YELLOW colored wires go in-line of the cylinder #2 (middle) Fuel Injector and the stock wiring harness.

The pair of PCV leads with ORANGE colored wires go in-line of the cylinder #1 (left-most) Fuel Injector and the stock wiring harness.

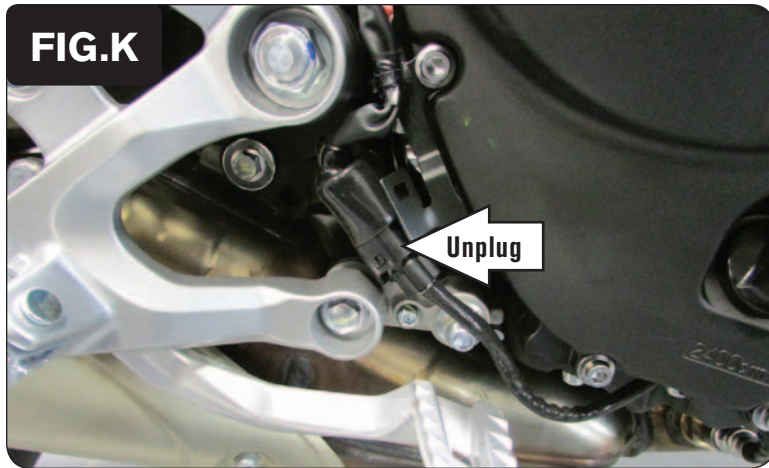

- 15 Locate and unplug the stock connector for the bike's stock O2 sensor (Fig. K).
This is a BLACK 4-pin connector near the right foot peg.

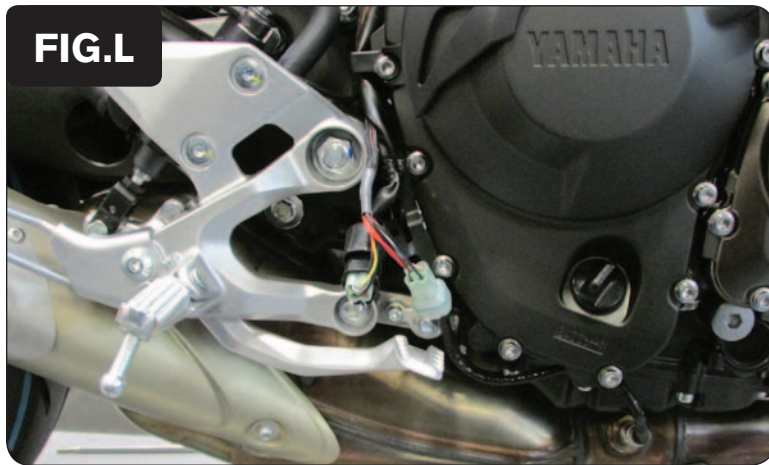

- 16 Plug the supplied O2 Optimizer in-line of the stock O2 sensor connectors (Fig. L).

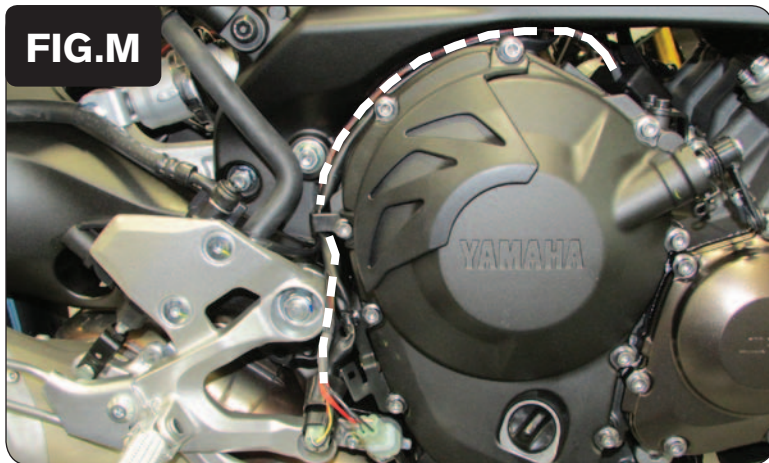

- 17 Route the O2 Optimizer wiring harness along-side the stock wiring up the back of the engine towards the top of the gear box (Fig. M).

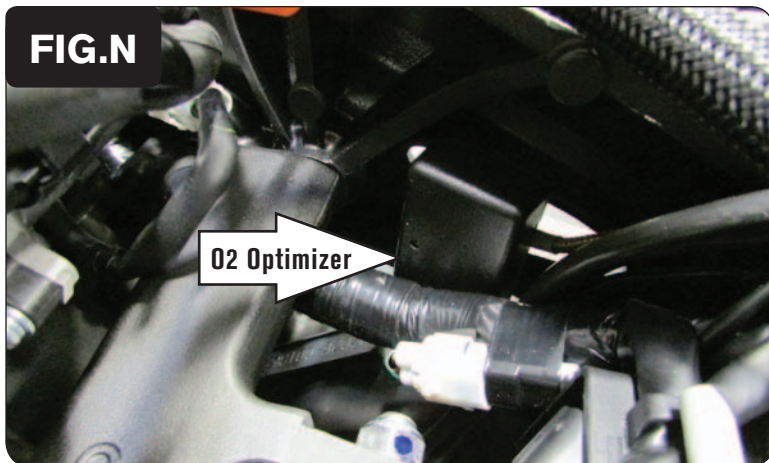

	0	2	5	10	15	20	40	60	80	100
500	0	0	0	0	0	0	0	0	0	0
750	0	0	0	0	0	0	0	0	0	0
1000	0	0	0	0	0	0	0	0	0	0
1250	0	0	0	0	0	0	0	0	0	0
1500	0	0	0	0	0	0	0	0	0	0
1750	0	0	0	0	0	0	0	0	0	0
2000	0	0	0	0	0	0	0	0	0	0
2250	0	0	0	0	0	0	0	0	0	0
2500	0	0	0	0	0	0	0	0	0	0
2750	0	0	0	0	0	0	0	0	0	0
3000	0	0	0	0	0	0	0	0	0	0
3250	0	0	0	0	0	0	0	0	0	0
3500	0	0	0	0	0	0	0	0	0	0
3750	0	0	0	0	0	0	0	0	0	0
4000	0	0	0	0	0	0	0	0	0	0
4250	0	0	0	0	0	0	0	0	0	0
4500	0	0	0	0	0	0	0	0	0	0
4750	0	0	0	0	0	0	0	0	0	0
5000	0	0	0	0	0	0	0	0	0	0
5250	0	0	0	0	0	0	0	0	0	0
5500	0	0	0	0	0	0	0	0	0	0
5750	0	0	0	0	0	0	0	0	0	0
6000	0	0	0	0	0	0	0	0	0	0
6250	0	0	0	0	0	0	0	0	0	0
6500	0	0	0	0	0	0	0	0	0	0
6750	0	0	0	0	0	0	0	0	0	0
7000	0	0	0	0	0	0	0	0	0	0
7250	0	0	0	0	0	0	0	0	0	0
7500	0	0	0	0	0	0	0	0	0	0
7750	0	0	0	0	0	0	0	0	0	0
8000	0	0	0	0	0	0	0	0	0	0
8250	0	0	0	0	0	0	0	0	0	0
8500	0	0	0	0	0	0	0	0	0	0
8750	0	0	0	0	0	0	0	0	0	0
9000	0	0	0	0	0	0	0	0	0	0

- Using one of the supplied Velcro strips, secure the O2 Optimizer module inside of the frame on the right side of the bike just above the gear box (Fig. N).

Use the supplied alcohol swab to clean the surface area prior to applying the Velcro.

- Reinstall the air box. Plug in the ECM. Reinstall the fuel tank and the seat.

Optional Inputs:

Speed - WHITE/YELLOW wire of speed sensor (just above the shift shaft)

12v source for Auto-tune - BLUE wire of WHITE 3-pin tail light connector

Tuning Notes:

The O2 Optimizer for this model controls the stock closed loop area. This area is represented by the highlighted cells shown in Figure O. The O2 Optimizer is designed to achieve a target AFR of 13.6:1. To use the O2 Optimizer you must retain your stock O2 sensor (even if using Auto-tune).

It is not necessary to change the values in the highlighted area of your fuel table. If using the Auto-tune system, do NOT input values in this area in your Target AFR table.

The light on the O2 Optimizer will blink while the sensor is being heated up. The unit is not functioning until the light is lit up solid.

This bike uses a fly-by-wire throttle control system, so conventional tuning can not be performed for all RPM and throttle ranges. You will notice that in the maps there are not detailed values below 2750 RPM at 40-100% throttle. This is because the throttle blades will not open more than 40% below this RPM range no matter how much throttle input is given. Therefore this area can not be tuned.

The GREY wire from the PCV is attached to the throttle blade angle sensor of the throttle bodies which is NOT directly correlated to the throttle grip position. Because of this, when setting the throttle position in the PCV software we recommend on resetting only the closed position (Minimum Voltage) while idling after the bike has completely warmed up. Use the arrow key (<) next to the Minimum Voltage setting to perform this step, and then click OK. Do not try to set the open or Maximum Voltage setting unless you are in gear on a dyno and above 4000 RPM.