

# [POWER COMMANDER V]

**2007-2009 Kawasaki Z1000**

**Installation Instructions**



## **PARTS LIST**

- 1 Power Commander
- 1 USB Cable
- 1 Installation Guide
- 2 Power Commander Decals
- 2 Dynojet Decals
- 2 Velcro strips
- 1 Dual Lock strip
- 1 Alcohol swab
- 1 Posi-tap

**THE IGNITION MUST BE TURNED  
OFF BEFORE INSTALLATION!**

THE LATEST POWER COMMANDER  
SOFTWARE AND MAP FILES CAN BE  
DOWNLOADED FROM OUR WEB SITE AT:  
[www.powercommander.com](http://www.powercommander.com)

**PLEASE READ ALL DIRECTIONS BEFORE STARTING INSTALLATION**

**Dynojet**

2191 Mendenhall Drive North Las Vegas, NV 89081 (800) 992-4993 [www.powercommander.com](http://www.powercommander.com)

# POWER COMMANDER V INPUT ACCESSORY GUIDE

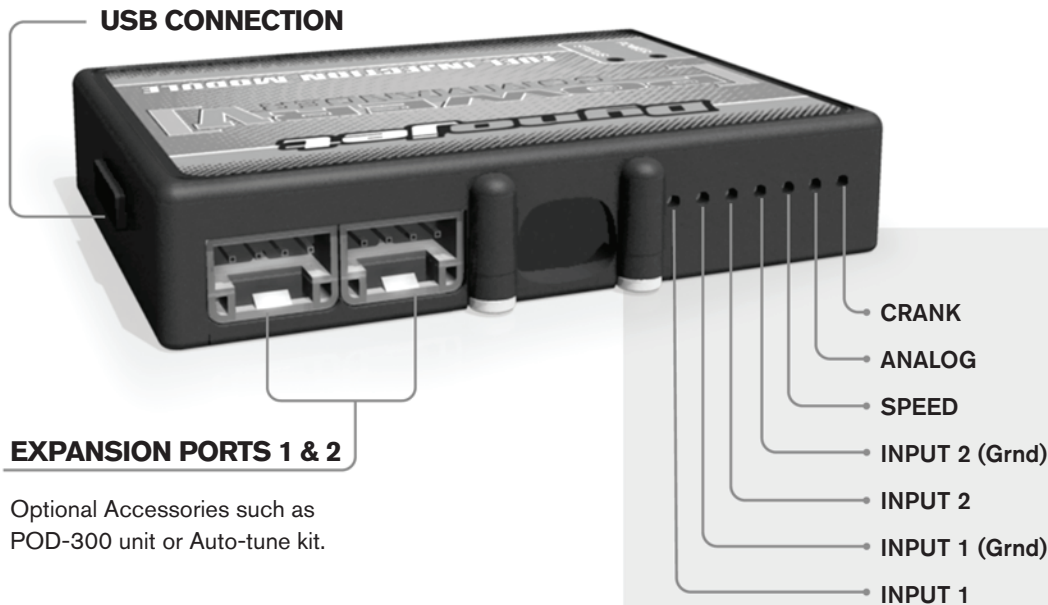

## Wire connections:

To input wires into the PCV first remove the rubber plug on the backside of the unit and loosen the screw for the corresponding input. Using a 22-24 gauge wire strip about 10mm from its end. Push the wire into the hole of the PCV until it stops and then tighten the screw. Make sure to reinstall the rubber plug.

NOTE: If you tin the wires with solder it will make inserting them easier.

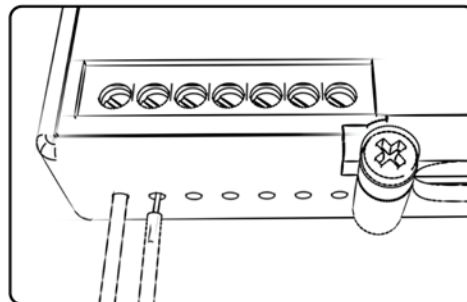

## ACCESSORY INPUTS

### Map -

(Input 1 or 2) The PCV has the ability to hold 2 different base maps. You can switch on the fly between these two base maps when you hook up a switch to the MAP inputs. You can use any open/close type switch. The polarity of the wires is not important. When using the Autotune kit one position will hold a base map and the other position will let you activate the learning mode. When the switch is "CLOSED" Autotune will be activated. (Set to Switch Input #1 by default.)

### Shifter-

(Input 1 or 2) These inputs are for use with the Dynojet quickshifter. Insert the wires from the Dynojet quickshifter into the SHIFTER inputs. The polarity of the wires is not important. (Set to Switch Input #2 by default.)

### Speed-

If your application has a speed sensor then you can tap into the signal side of the sensor and run a wire into this input. This will allow you to calculate gear position in the Control Center Software. Once gear position is setup you can alter your map based on gear position and setup gear dependent kill times when using a quickshifter.

### Analog-

This input is for a 0-5v signal such as engine temp, boost, etc. Once this input is established you can alter your fuel curve based on this input in the control center software.

### Crank-

Do **NOT** connect anything to this port unless instructed to do so by Dynojet. It is used to transfer crank trigger data from one module to another.

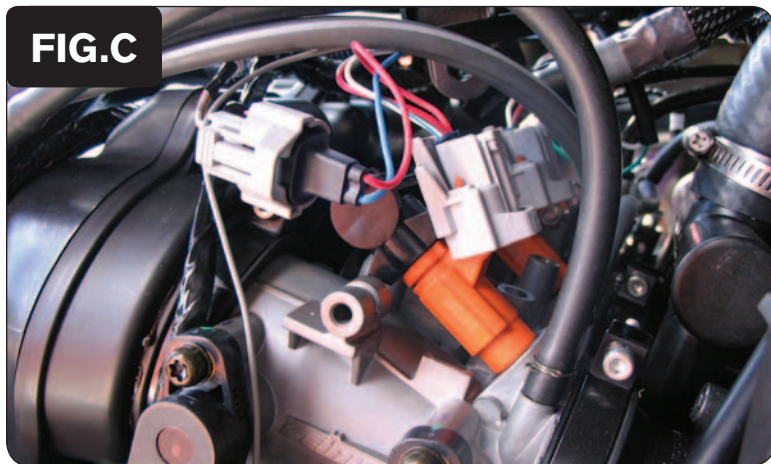
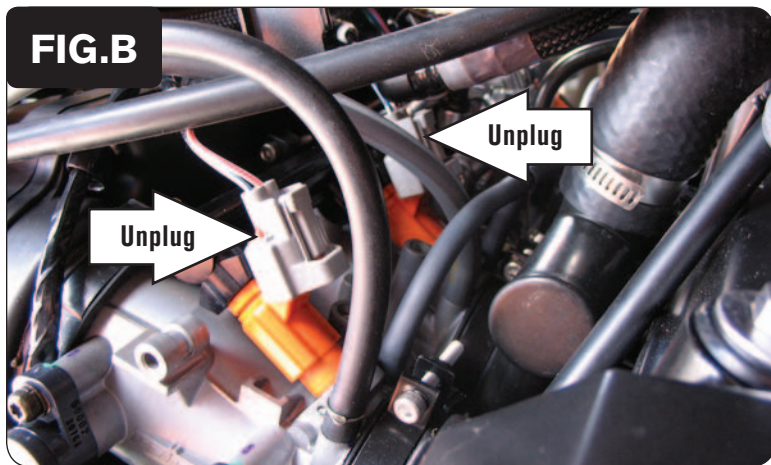
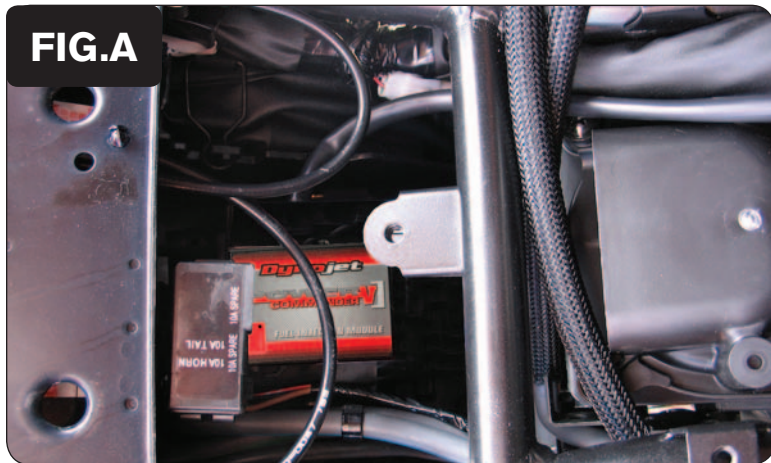

- 1 Remove the main seat and the passenger seat.  
*The installation can be done without removing the fuel tank, but it may make the installation easier by doing so.*
- 2 Mount the PCV to the inner rear fender, behind the air box (Fig. A).  
*The supplied Velcro can be used to secure the module, if necessary. Clean both surfaces with the supplied alcohol swab prior to attaching the Velcro.*
- 3 Route the harness towards the front of the bike along the left hand frame tube.

- 4 Unplug the stock wiring harness from each of the 4 fuel injectors (Fig. B).

*Figure B only shows the #3 and #4 injector. You will need to also remove the harness from #1 and #2.*

- 5 Plug the PCV wiring harness in-line of the stock harness and injectors (Fig. C).

PCV harness:

*ORANGE - cylinder #1 (left)*

*YELLOW - cylinder #2*

*GREEN - cylinder #3*

*BLUE - cylinder #4 (right)*

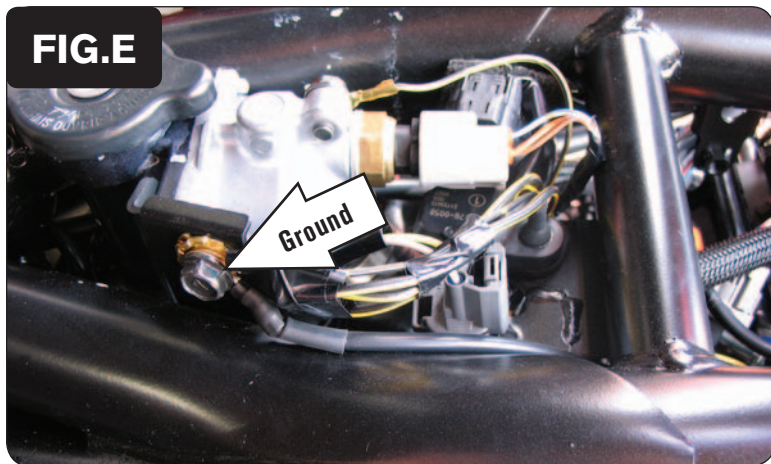
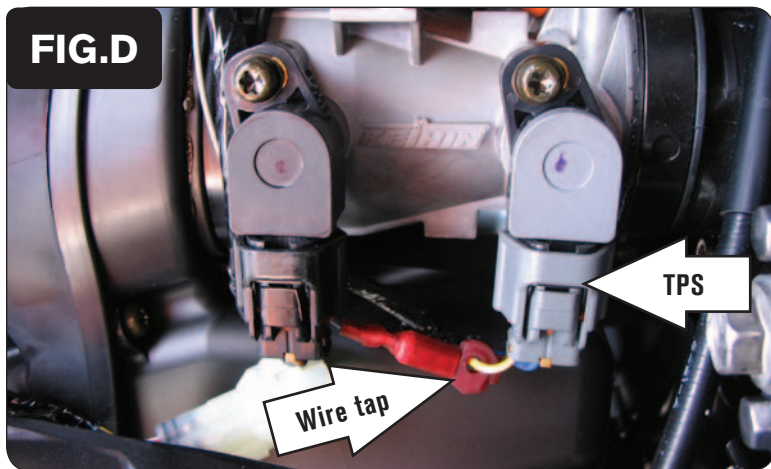

6 Locate the Throttle Position Sensor connector (Fig. D).

*This connector is located on the right hand side of the throttle bodies and is GREY in color.*

7 Attach the supplied Posi-tap to the YELLOW/WHITE wire of the TPS.

*This connection can be made further up the harness to make it less noticeable if desired.*

*The wire tap used in Figure D is not a Posi-tap. It is an older crimp-on style t-tap.*

8 Connect the GREY wire from the PCV to the Posi-tap (Fig. D).

9 Attach the ground wire from the PCV to the stock ground wire next to the thermostat housing (Fig. E).

10 Reinstall fuel tank.

#### Optional inputs:

**Speed** - PINK wire of speed sensor. Located on engine case above the front sprocket cover.

**Engine Temperature** - BLUE/WHITE wire of temp sensor on thermostat housing located under fuel tank (seen in Figure E).

