

[POWER COMMANDER V]

2010-2013 Kawasaki Z1000 / Ninja 1000

Installation Instructions



PARTS LIST

- 1 Power Commander
- 1 USB Cable
- 1 Installation Guide
- 2 Power Commander Decals
- 2 Dynojet Decals
- 2 Velcro strips
- 1 Alcohol swab

**THE IGNITION MUST BE TURNED
OFF BEFORE INSTALLATION!**

THE LATEST POWER COMMANDER
SOFTWARE AND MAP FILES CAN BE
DOWNLOADED FROM OUR WEB SITE AT:
www.powercommander.com

PLEASE READ ALL DIRECTIONS BEFORE STARTING INSTALLATION

Dynojet

2191 Mendenhall Drive North Las Vegas, NV 89081 (800) 992-4993 www.powercommander.com

POWER COMMANDER V INPUT ACCESSORY GUIDE

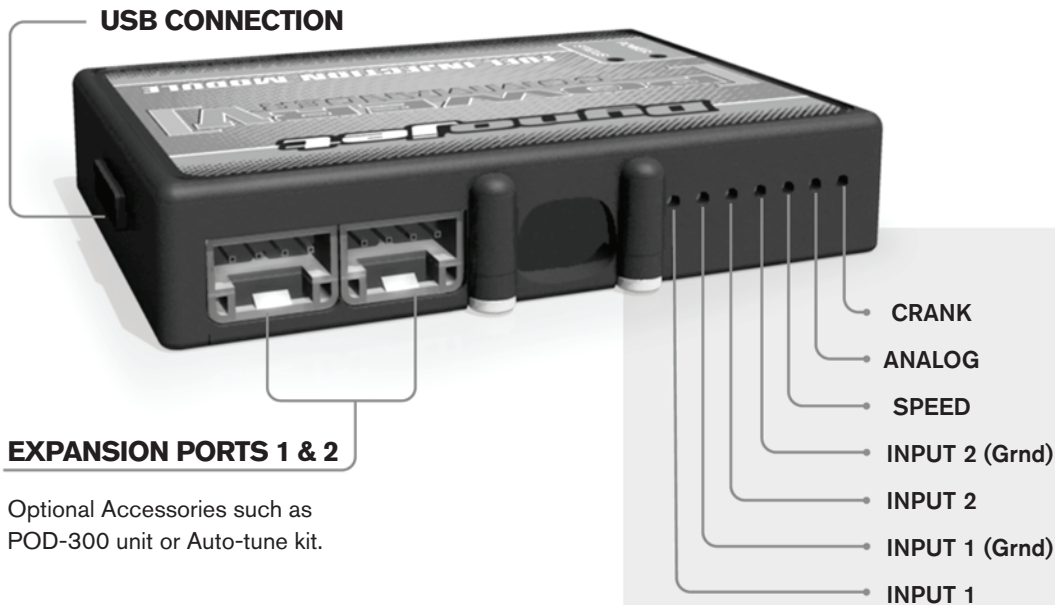

Wire connections:

To input wires into the PCV first remove the rubber plug on the backside of the unit and loosen the screw for the corresponding input. Using a 22-24 gauge wire strip about 10mm from its end. Push the wire into the hole of the PCV until it stops and then tighten the screw. Make sure to reinstall the rubber plug.

NOTE: If you tin the wires with solder it will make inserting them easier.

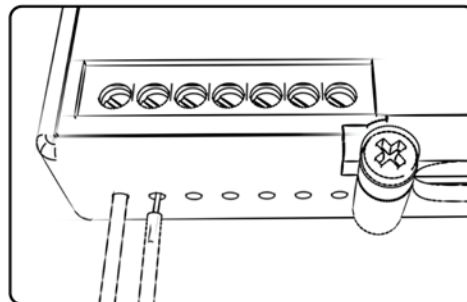

ACCESSORY INPUTS

Map -

(Input 1 or 2) The PCV has the ability to hold 2 different base maps. You can switch on the fly between these two base maps when you hook up a switch to the MAP inputs. You can use any open/close type switch. The polarity of the wires is not important. When using the Autotune kit one position will hold a base map and the other position will let you activate the learning mode. When the switch is "CLOSED" Autotune will be activated. (Set to Switch Input #1 by default.)

Shifter-

(Input 1 or 2) These inputs are for use with the Dynojet quickshifter. Insert the wires from the Dynojet quickshifter into the SHIFTER inputs. The polarity of the wires is not important. (Set to Switch Input #2 by default.)

Speed-

If your application has a speed sensor then you can tap into the signal side of the sensor and run a wire into this input. This will allow you to calculate gear position in the Control Center Software. Once gear position is setup you can alter your map based on gear position and setup gear dependent kill times when using a quickshifter.

Analog-

This input is for a 0-5v signal such as engine temp, boost, etc. Once this input is established you can alter your fuel curve based on this input in the control center software.

Crank-

Do **NOT** connect anything to this port unless instructed to do so by Dynojet. It is used to transfer crank trigger data from one module to another.

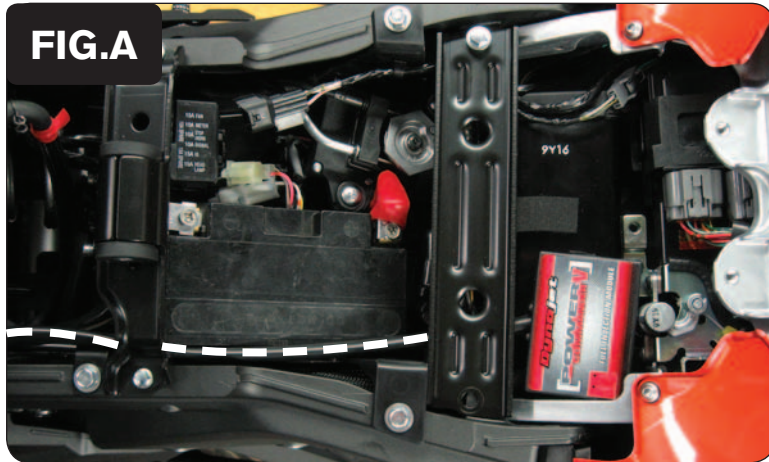

- 1 Remove the main seat and the passenger seat.
- 2 Remove the fuel tank.
- 3 Mount the PCV to the inner rear fender under the main seat (Fig. A). Use the supplied velcro to secure the unit in place.
For bikes with a charcoal canister it will sit on top of the canister.
- 4 Route the harness towards the front of the bike along the left hand frame tube.

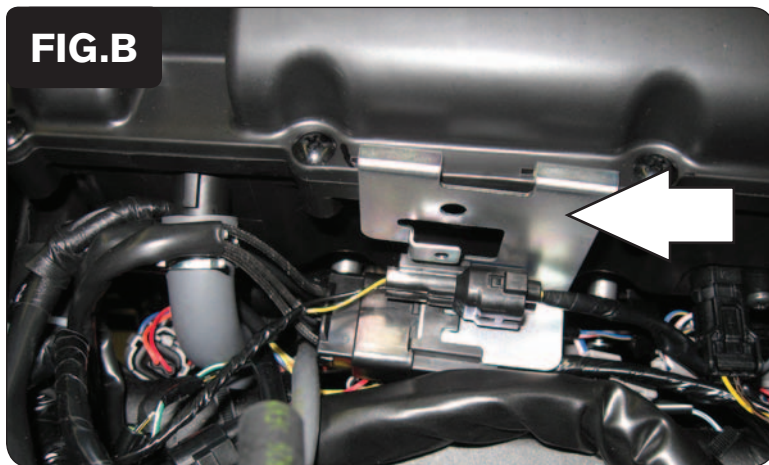

- 5 Slide the bracket at the rear of the air box upwards.
This allows access to the injectors.

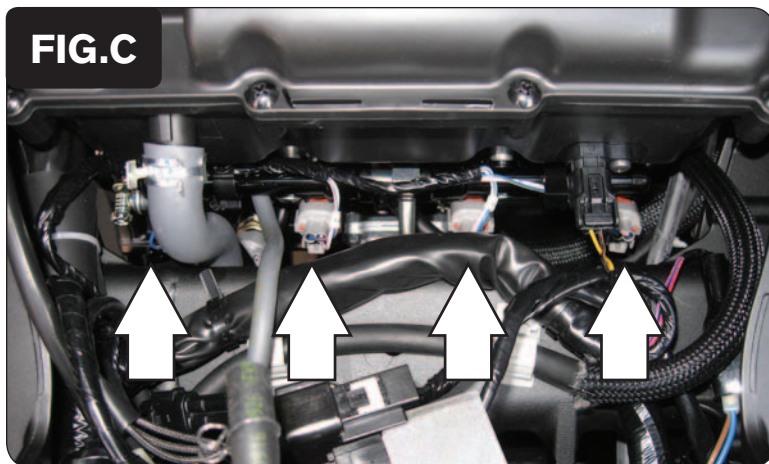

- 6 Unplug the stock wiring harness from each of the 4 injectors.

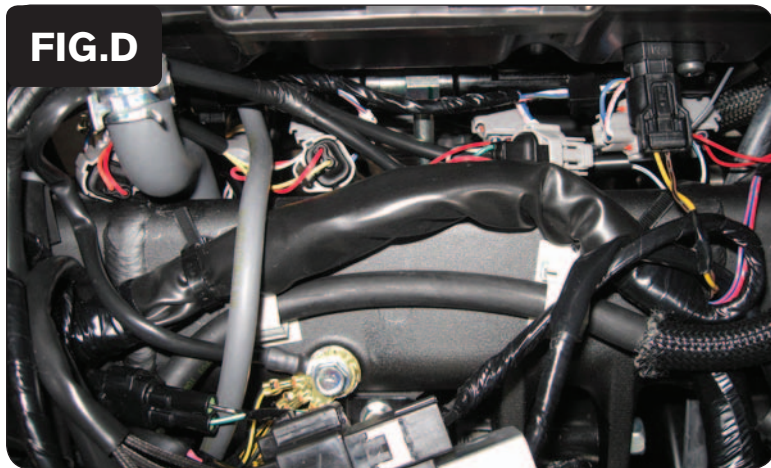

7 Plug the PCV wiring harness in-line of the stock harness and injectors (Fig. C).

PCV harness:

ORANGE - cylinder #1 (left)

YELLOW - cylinder #2

GREEN - cylinder #3

BLUE - cylinder #4 (right)

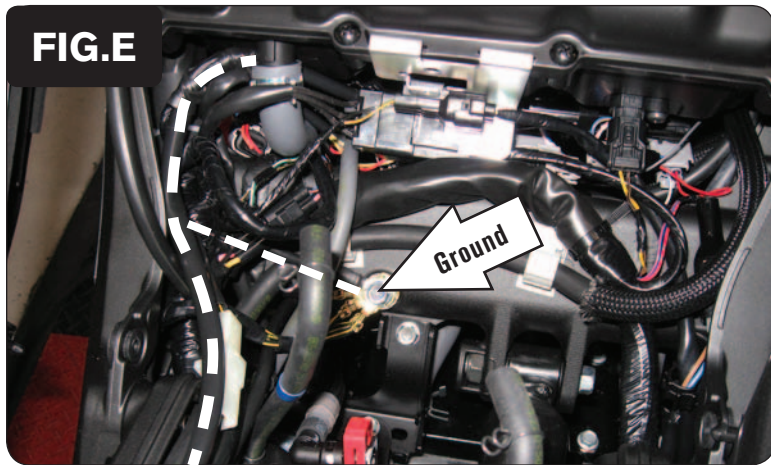

8 Attach the ground wire from the PCV to the common stock ground wire location (Fig. E).



9 Locate the Throttle Position Sensor on the right hand side of the bike

*This sensor is behind the coolant hose shown in Figure F and is the BLACK connector, **NOT** the GREY connector.*

FIG.G

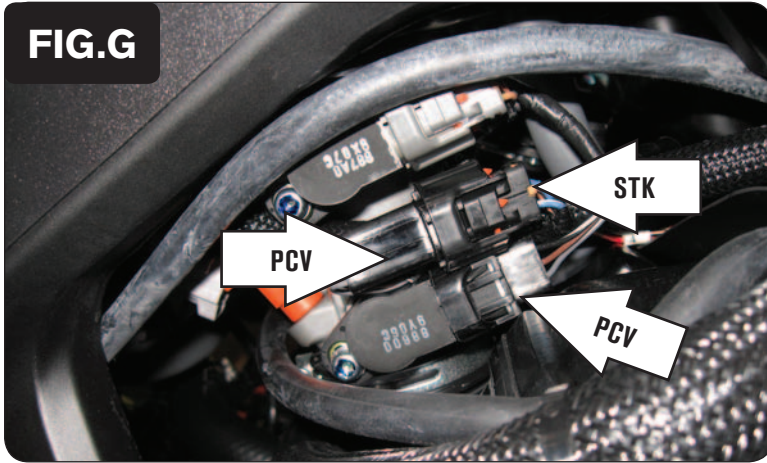

- 10 Unplug the stock wiring harness from the TPS and connect the PCV in-line of the stock wiring harness and TPS (Fig. G).
- 11 Reinstall fuel tank and bodywork.

Optional inputs:

Speed input - YELLOW wire of speed sensor. Located on front sprocket cover.

Engine Temperature - WHITE/RED wire of temp sensor located under cylinder #1 intake manifold on rear of cylinder.