

[POWER COMMANDER V]

FUEL AND IGNITION

2010-2015 Kawasaki W800

Installation Instructions



PARTS LIST

- 1 Power Commander
- 1 USB Cable
- 1 Installation Guide
- 2 Power Commander Decals
- 2 Dynojet Decals
- 2 Velcro strips
- 1 Alcohol swab

**THE IGNITION MUST BE TURNED
OFF BEFORE INSTALLATION!**

THE LATEST POWER COMMANDER
SOFTWARE AND MAP FILES CAN BE
DOWNLOADED FROM OUR WEB SITE AT:
www.powercommander.com

PLEASE READ ALL DIRECTIONS BEFORE STARTING INSTALLATION

Dynojet

2191 Mendenhall Drive North Las Vegas, NV 89081 (800) 992-4993 www.powercommander.com

POWER COMMANDER V INPUT ACCESSORY GUIDE

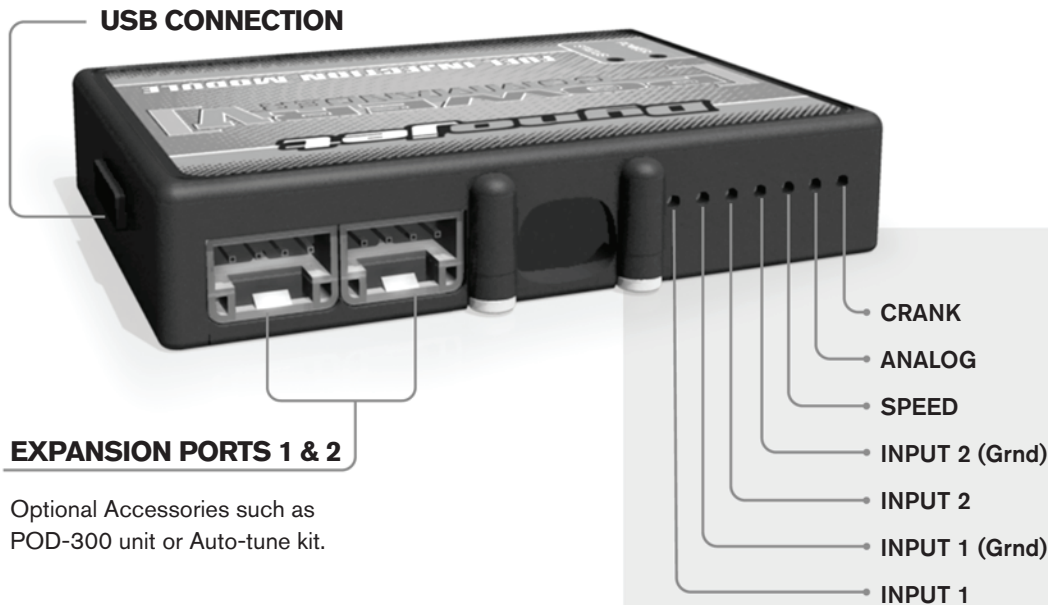

Wire connections:

To input wires into the PCV first remove the rubber plug on the backside of the unit and loosen the screw for the corresponding input. Using a 22-24 gauge wire strip about 10mm from its end. Push the wire into the hole of the PCV until it stops and then tighten the screw. Make sure to reinstall the rubber plug.

NOTE: If you tin the wires with solder it will make inserting them easier.

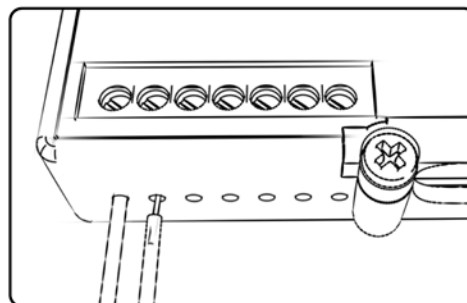

ACCESSORY INPUTS

Map -

(Input 1 or 2) The PCV has the ability to hold 2 different base maps. You can switch on the fly between these two base maps when you hook up a switch to the MAP inputs. You can use any open/close type switch. The polarity of the wires is not important. When using the Autotune kit one position will hold a base map and the other position will let you activate the learning mode. When the switch is "CLOSED" Autotune will be activated. (Set to Switch Input #1 by default.)

Shifter-

(Input 1 or 2) These inputs are for use with the Dynojet quickshifter. Insert the wires from the Dynojet quickshifter into the SHIFTER inputs. The polarity of the wires is not important. (Set to Switch Input #2 by default.)

Speed-

If your application has a speed sensor then you can tap into the signal side of the sensor and run a wire into this input. This will allow you to calculate gear position in the Control Center Software. Once gear position is setup you can alter your map based on gear position and setup gear dependent kill times when using a quickshifter.

Analog-

This input is for a 0-5v signal such as engine temp, boost, etc. Once this input is established you can alter your fuel curve based on this input in the control center software.

Crank-

Do **NOT** connect anything to this port unless instructed to do so by Dynojet. It is used to transfer crank trigger data from one module to another.

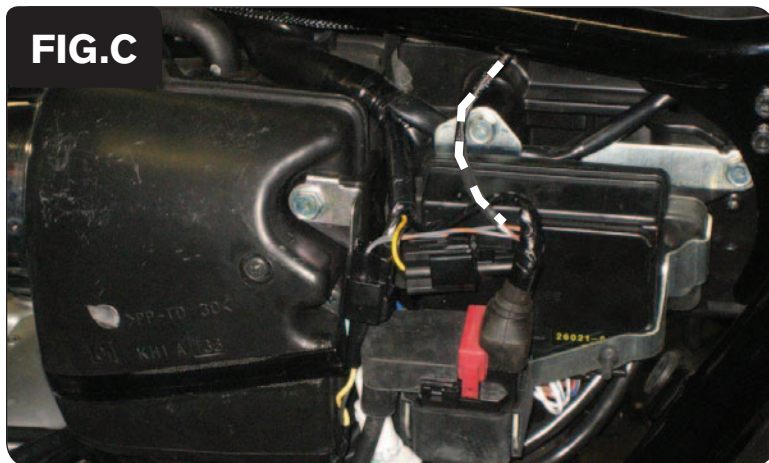
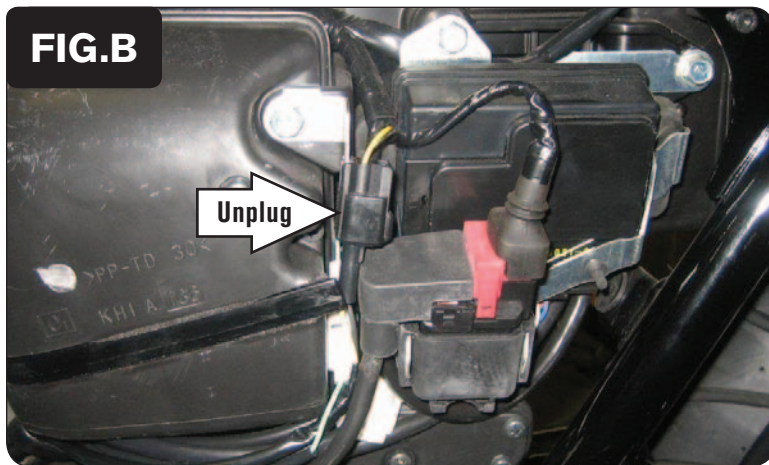
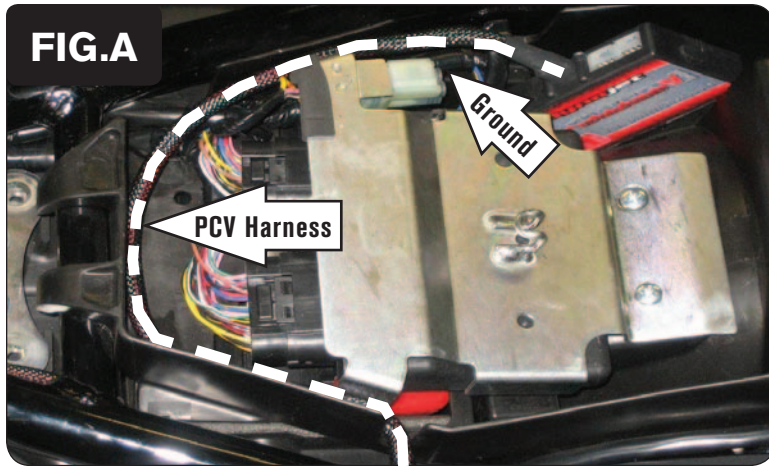

- 1 Remove the seat, the fuel tank, and both the left and right side airbox covers.
- 2 Install the PCV module in the trunk area using the supplied Velcro.
Be sure to clean the surface with the supplied alcohol swab prior to applying the Velcro.
- 3 Secure the ground wire of the PCV harness with the small ring lug to the negative (-) terminal of the bike's battery.
- 4 Reinstall the metal ECU cover and the tool kit.
- 5 Route the PCV harness around the stock ECU to the left side of the bike and through the small opening in the plastic (Fig. A).
- 6 Locate and unplug the stock Crank Position Sensor connectors (Fig. B).
This is a pair of BLACK 2-pin connectors.
- 7 Route the PCV harness under the frame rail.
- 8 Plug the matching pair of PCV harness connectors in-line of the stock Crank Position Sensor connectors (Fig. C).
- 9 Continue routing the rest of the PCV harness forward toward the throttle bodies following along the inside of the frame rail.

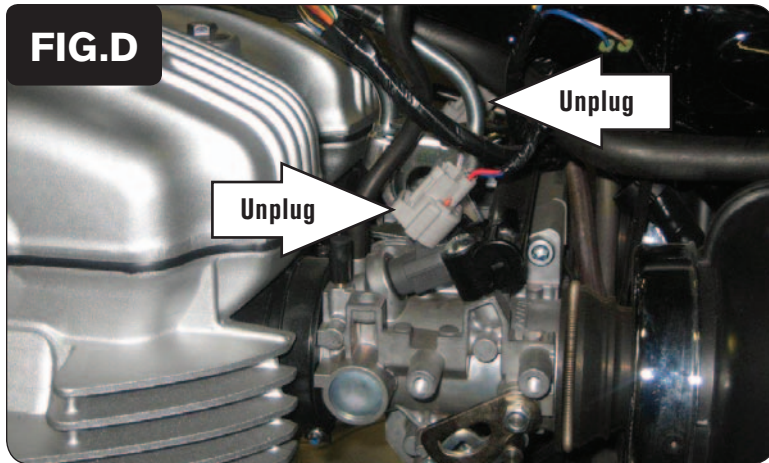

- 10 Locate and unplug the stock wiring harness from the fuel injectors (Fig. D).



- 11 Plug the 2 pairs of PCV fuel injector connectors in-line with the stock injector connectors and the injectors (Fig. E).

The pair of PCV connectors with ORANGE colored wires go in-line with the cylinder #1 (left) injector.

The pair of PCV connectors with YELLOW colored wires go in-line with the cylinder #2 (right) injector.

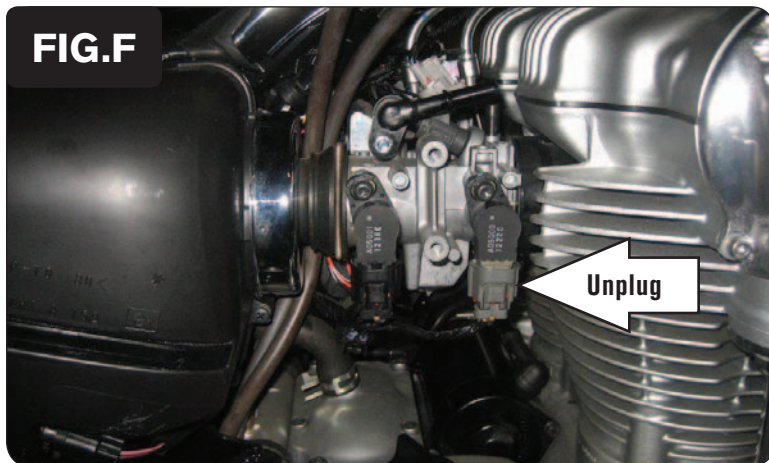

- 12 Route the pair of 3-pin PCV connectors over to the right side of the throttle bodies.
- 13 Locate and unplug the Primary Throttle Position Sensor (Fig. F).

The PRIMARY TPS is the one with the GREY connector. The SECONDARY TPS has a BLACK connector. Be sure to connect the PCV to the PRIMARY TPS (with the GREY connector).

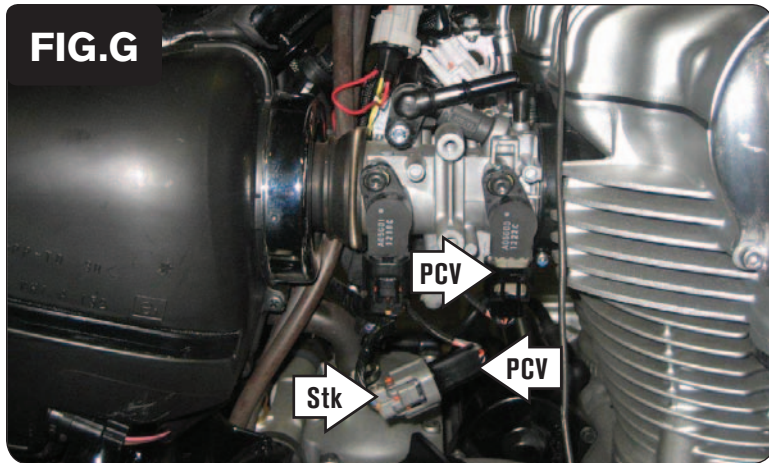

- 14 Plug the pair of 3-pin PCV connectors in-line of the PRIMARY TPS and stock wiring harness (Fig. G).

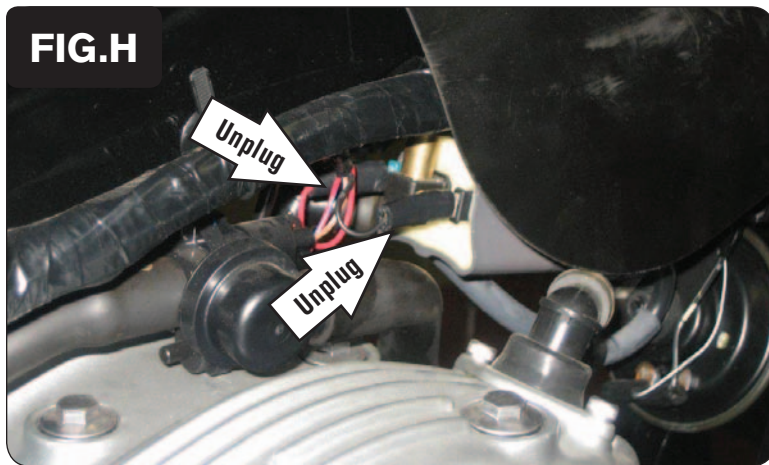

- 15 Route the rest of the PCV harness below the frame tube and to the bike's ignition coil.
- 16 Locate and unplug the stock coil wires (Fig. H).



- 17 Plug the RED/WHITE wires of the PCV harness in-line of the stock RED wire and the GREEN coil tab.
- 18 Plug the GREEN and WHITE/GREEN wires of the PCV harness in-line of the stock BLACK wire and the BLACK coil tab.
- 19 Reinstall the airbox covers, the fuel tank, and the seat.

Optional Input:

Speed - PINK/BLUE wire from speed sensor connector or pin #14 on smaller ECU connector. Speed sensor connector is located on the left side of the bike near the Crank Position Sensor connectors.