

[POWER COMMANDER V]

FUEL AND IGNITION

2009-2013 KTM 990 SMR/SMT

Installation Instructions



PARTS LIST

- 1 Power Commander
- 1 USB Cable
- 1 Installation Guide
- 2 Power Commander Decals
- 2 Dynojet Decals
- 2 Velcro strips
- 1 Alcohol swab

THE IGNITION MUST BE TURNED OFF BEFORE INSTALLATION!

THE LATEST POWER COMMANDER SOFTWARE AND MAP FILES CAN BE DOWNLOADED FROM OUR WEB SITE AT:
www.powercommander.com

PLEASE READ ALL DIRECTIONS BEFORE STARTING INSTALLATION

Dynojet

2191 Mendenhall Drive North Las Vegas, NV 89081 (800) 992-4993 www.powercommander.com

POWER COMMANDER V INPUT ACCESSORY GUIDE

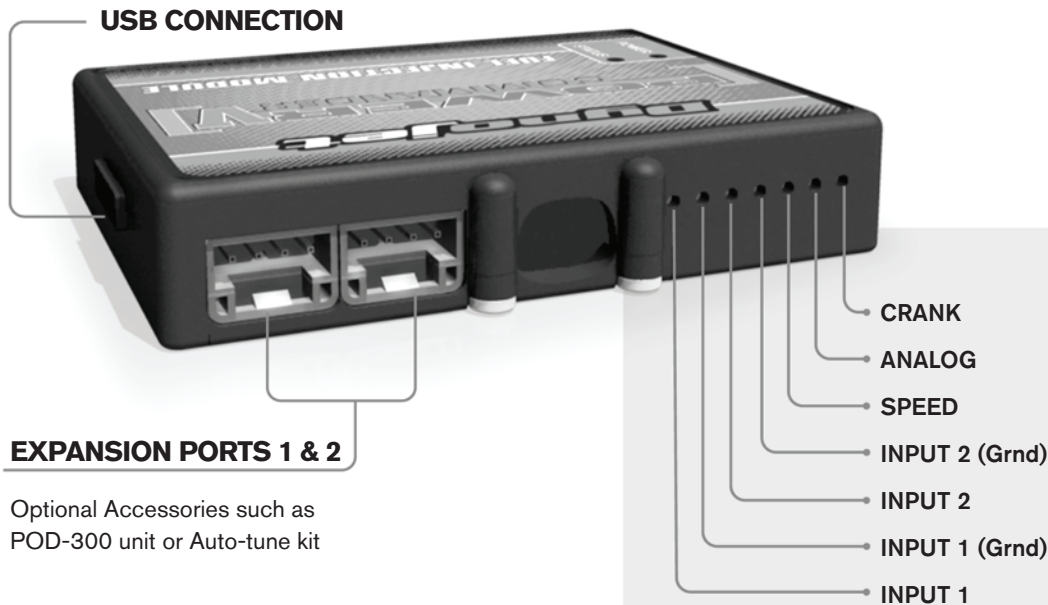

Wire connections:

To input wires into the PCV first remove the rubber plug on the backside of the unit and loosen the screw for the corresponding input. Using a 22-24 gauge wire strip about 10mm from its end. Push the wire into the hole of the PCV until it stops and then tighten the screw. Make sure to reinstall the rubber plug.

NOTE: If you tin the wires with solder it will make inserting them easier.

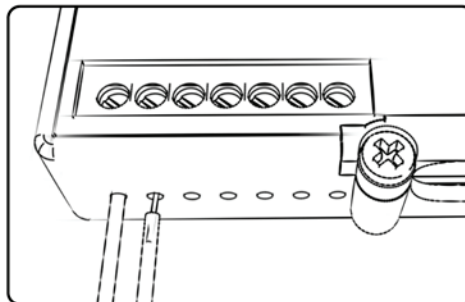

ACCESSORY INPUTS

Map -

(Input 1 or 2) The PCV has the ability to hold 2 different base maps. You can switch on the fly between these two base maps when you hook up a switch to the MAP inputs. You can use any open/close type switch. The polarity of the wires is not important. When using the Autotune kit one position will hold a base map and the other position will let you activate the learning mode. When the switch is "CLOSED" Autotune will be activated. (Set to Switch Input #1 by default.)

Shifter-

(Input 1 or 2) These inputs are for use with the Dynojet quickshifter. Insert the wires from the Dynojet quickshifter into the SHIFTER inputs. The polarity of the wires is not important. (Set to Switch Input #2 by default.)

Speed-

If your application has a speed sensor then you can tap into the signal side of the sensor and run a wire into this input. This will allow you to calculate gear position in the Control Center Software. Once gear position is setup you can alter your map based on gear position and setup gear dependent kill times when using a quickshifter.

Analog-

This input is for a 0-5v signal such as engine temp, boost, etc. Once this input is established you can alter your fuel curve based on this input in the control center software.

Crank-

Do **NOT** connect anything to this port unless instructed to do so by Dynojet. It is used to transfer crank trigger data from one module to another.

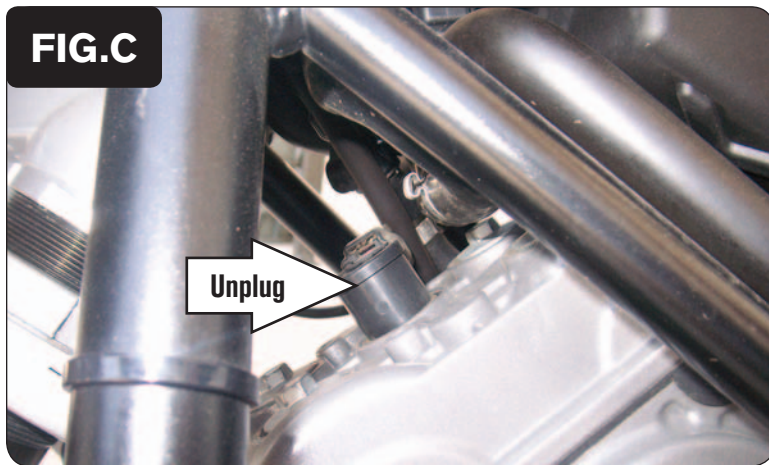
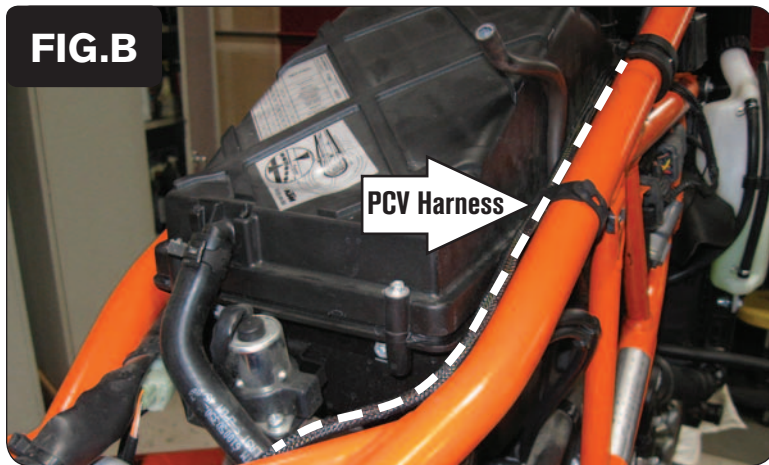

- 1 Remove the seat, both side fairings, and the chin fairing.
- 2 Prop the fuel tank up.
- 3 Secure the PCV module in the tail section using the supplied Velcro.
Clean both surfaces with the supplied alcohol swab prior to applying the Velcro.
- 4 Route the PCV harness along the frame going under the crossover section (Fig. A).

- 5 Continue routing harness along the right side of the frame between the frame and the airbox (Fig. B).
Use the stock wire ties to secure the PCV harness in place.

- 6 Locate the Rear Ignition Coil and unplug the stock wiring harness from the coil (Fig. C).
Rotate the coil stick 180 degrees so the connection is pointing to the right side of the motorcycle.

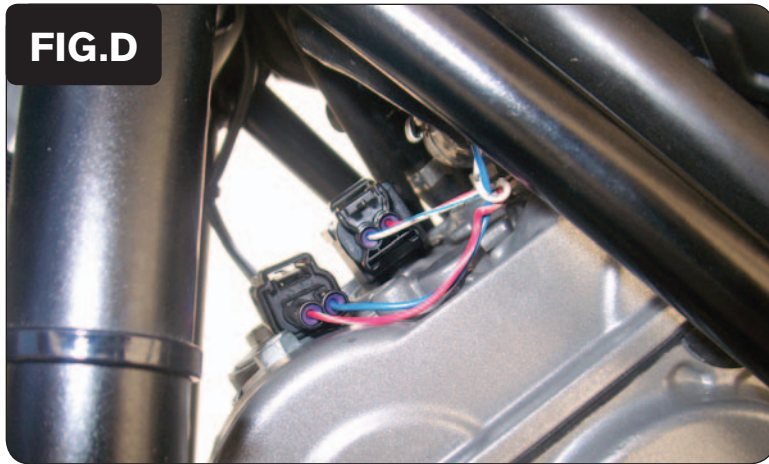

- 7 Plug the pair of PCV connectors with BLUE colored wires in-line of the Rear Ignition Coil and the stock wiring harness (Fig. D).

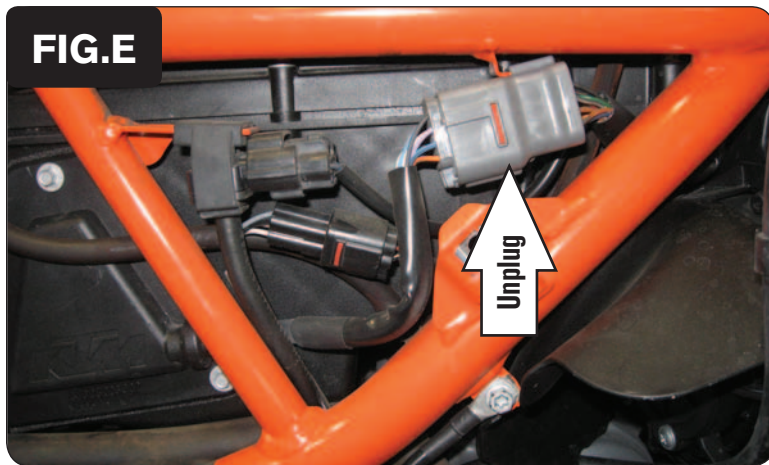

- 8 Locate the stock connector from the throttle bodies on the right side of the motorcycle. Unplug this connector (Fig. E).
This is a GREY 16-pin connector pair.

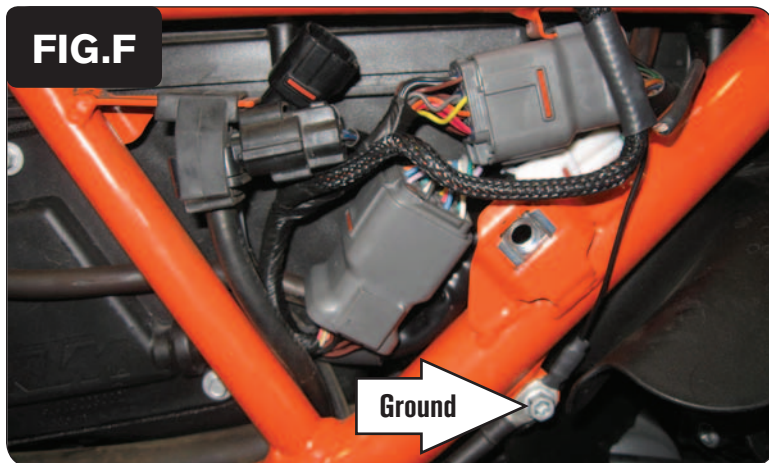

- 9 Plug the PCV in-line of the stock wiring harness.
- 10 Attach the PCV ground wire with the small ring lug to the stock common ground location on the right side of the frame (Fig. F).

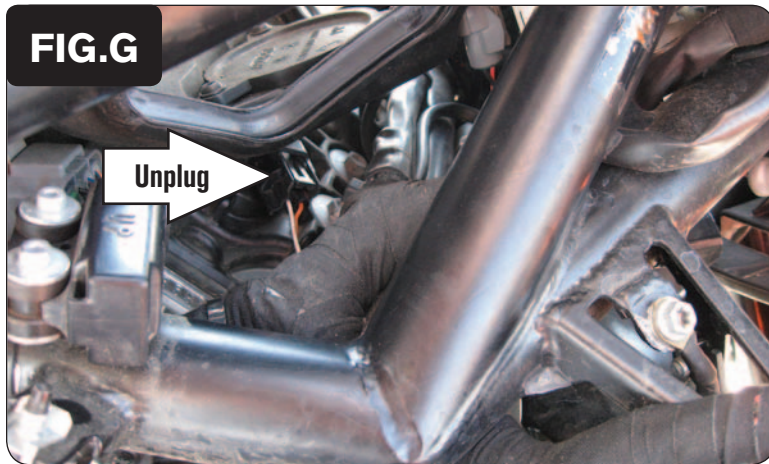

- 11 Locate the Front Ignition Coil and unplug the stock wiring harness from the coil (Fig. G).
- 12 Plug the pair of PCV connectors with the GREEN colored wires in-line of the Rear Ignition Coil and the stock wiring harness.

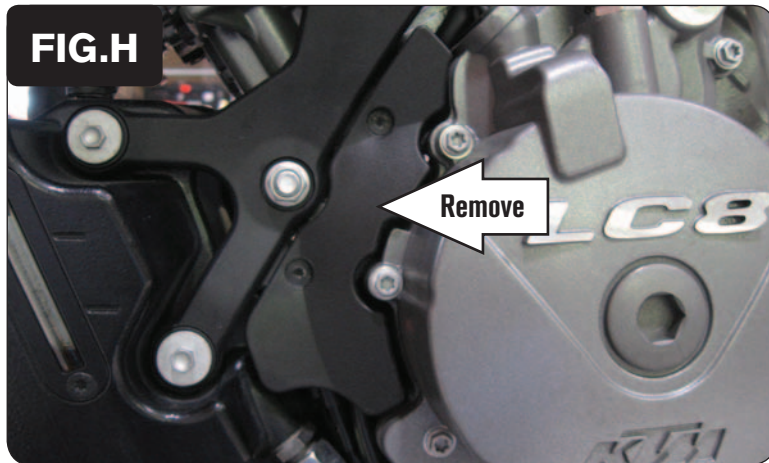

- 13 Remove the small plastic cover on the left side of the engine (Fig. H).

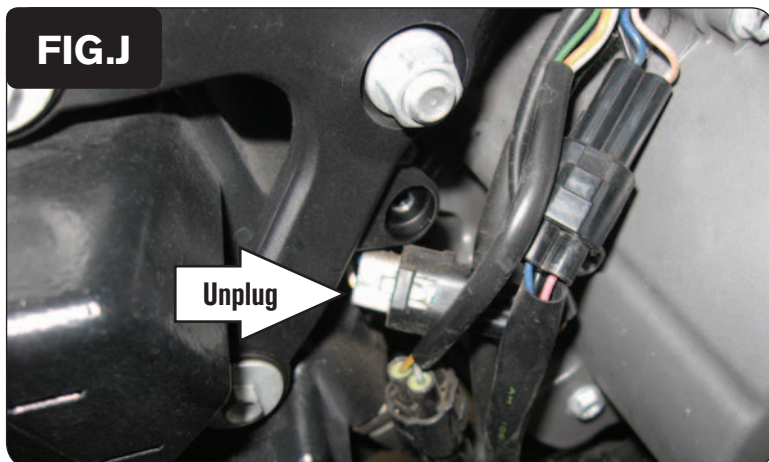

- 14 Unplug the stock Crank Position Sensor connectors (Fig. J).
This is a 2-pin connector pair. The MALE connector is WHITE. The FEMALE connector is BLACK.

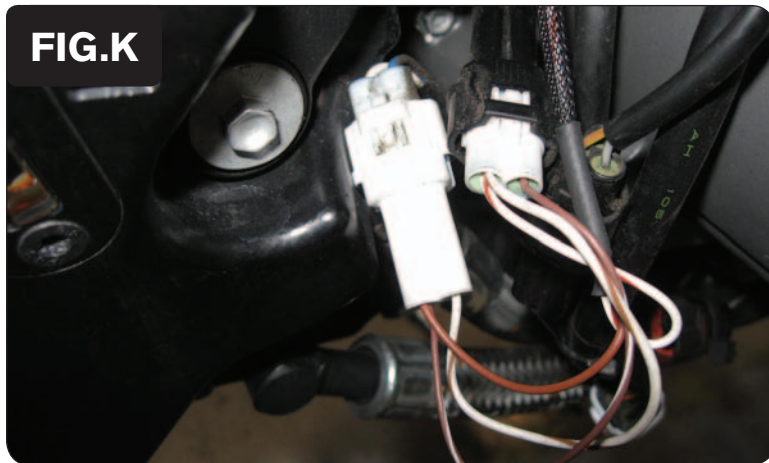

- 15 Plug the PCV wiring harness in-line of the stock CPS connectors (Fig. K).
- 16 Reinstall the small plastic cover.
- 17 Reinstall the fuel tank, all of the removed bodywork, and the seats.