

# [POWER COMMANDER V]

## **2014-2015 KTM 1190 Adventurer**

### **Installation Instructions**



#### **PARTS LIST**

- 1 Power Commander
- 1 USB Cable
- 1 Installation Guide
- 2 Power Commander Decals
- 2 Dynojet Decals
- 2 Velcro Strips
- 1 Alcohol Swab
- 1 Posi-tap
- 1 Zip tie

**THE IGNITION MUST BE TURNED OFF BEFORE INSTALLATION!**

THE LATEST POWER COMMANDER SOFTWARE AND MAP FILES CAN BE DOWNLOADED FROM OUR WEB SITE AT:  
[www.powercommander.com](http://www.powercommander.com)

**PLEASE READ ALL DIRECTIONS BEFORE STARTING INSTALLATION**

**Dynojet**

2191 Mendenhall Drive North Las Vegas, NV 89081 (800) 992-4993 [www.powercommander.com](http://www.powercommander.com)

# POWER COMMANDER V INPUT ACCESSORY GUIDE

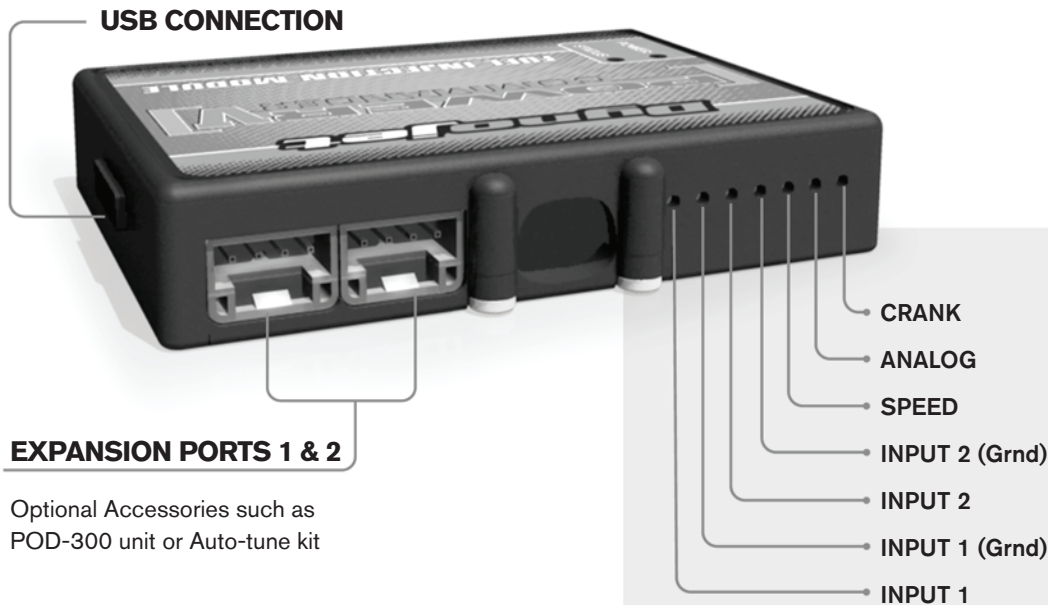

Optional Accessories such as  
POD-300 unit or Auto-tune kit

## Wire connections:

To input wires into the PCV first remove the rubber plug on the backside of the unit and loosen the screw for the corresponding input. Using a 22-24 gauge wire strip about 10mm from its end. Push the wire into the hole of the PCV until it stops and then tighten the screw. Make sure to reinstall the rubber plug.

NOTE: If you tin the wires with solder it will make inserting them easier.

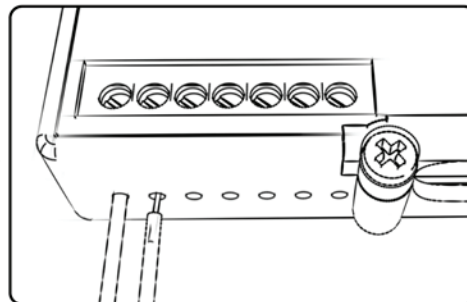

## ACCESSORY INPUTS

### Map -

(Input 1 or 2) The PCV has the ability to hold 2 different base maps. You can switch on the fly between these two base maps when you hook up a switch to the MAP inputs. You can use any open/close type switch. The polarity of the wires is not important. When using the Autotune kit one position will hold a base map and the other position will let you activate the learning mode. When the switch is "CLOSED" Autotune will be activated. (Set to Switch Input #1 by default.)

### Shifter-

(Input 1 or 2) These inputs are for use with the Dynojet quickshifter. Insert the wires from the Dynojet quickshifter into the SHIFTER inputs. The polarity of the wires is not important. (Set to Switch Input #2 by default.)

### Speed-

If your application has a speed sensor then you can tap into the signal side of the sensor and run a wire into this input. This will allow you to calculate gear position in the Control Center Software. Once gear position is setup you can alter your map based on gear position and setup gear dependent kill times when using a quickshifter.

### Analog-

This input is for a 0-5v signal such as engine temp, boost, etc. Once this input is established you can alter your fuel curve based on this input in the control center software.

### Crank-

Do **NOT** connect anything to this port unless instructed to do so by Dynojet. It is used to transfer crank trigger data from one module to another.



- 1 Remove both seats. Remove the 2 panels at both sides of the fuel tank. Remove the small panel on top of the fuel tank. Remove the fuel tank.
- 2 Use the supplied Velcro strips to secure the PCV module in the tail section (Fig. A).

*Clean both surfaces with the supplied alcohol swab prior to applying the Velcro adhesive.*

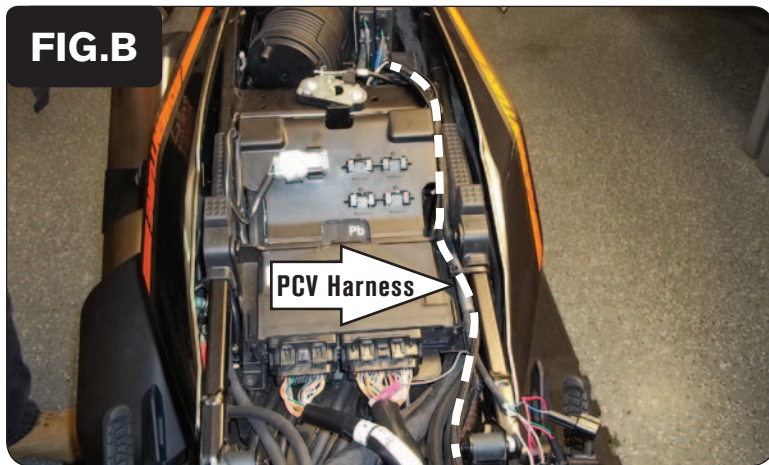

- 3 Route the PCV harness down the left side of the motorcycle going towards the engine (Fig. B).

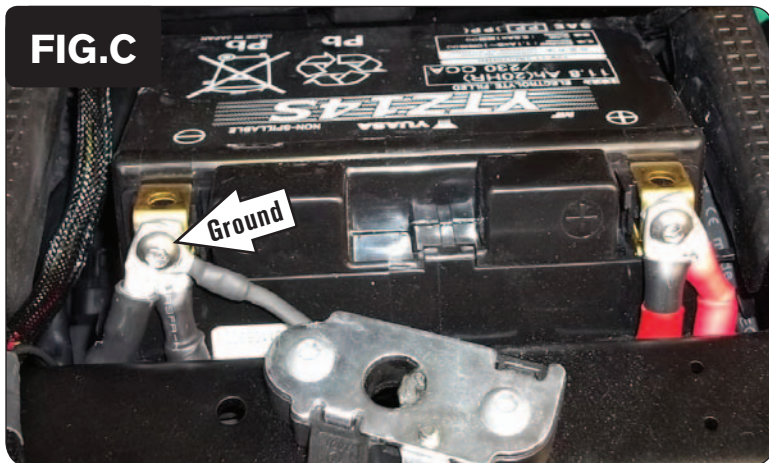

- 4 Connect the ground wire of the PCV to the negative side of the battery (Fig. C).

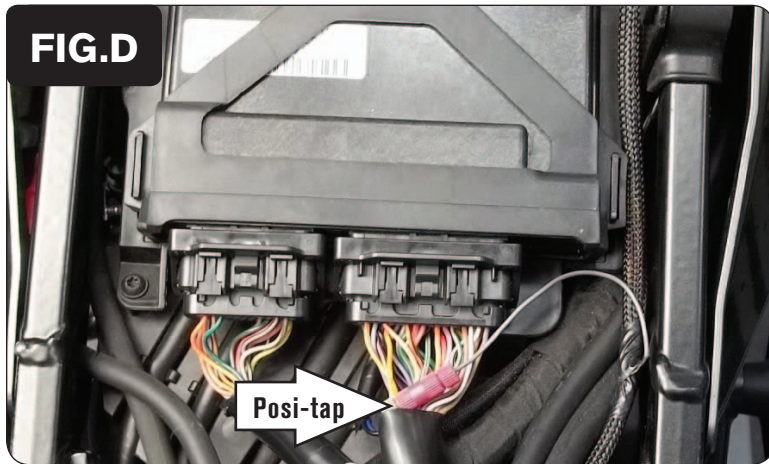

- 5 Using the supplied Posi-tap secure the GREY wire of the PCV to the stock ORANGE/YELLOW wire of the larger ECU connector (Fig. D).

*This allows the PCV to see the Throttle Position Signal.*

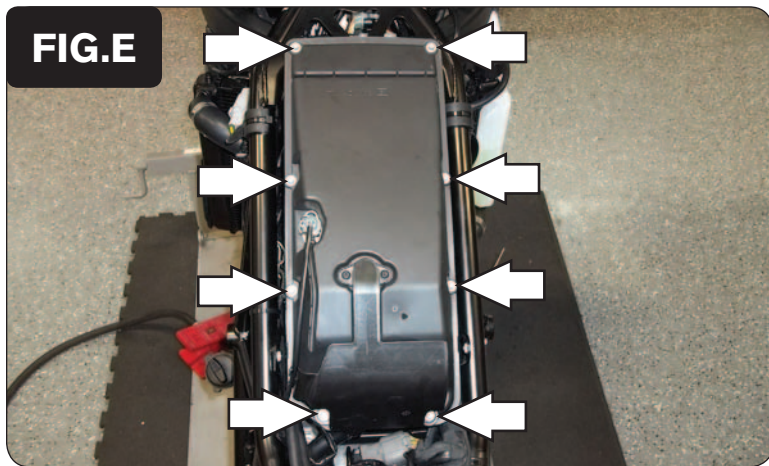
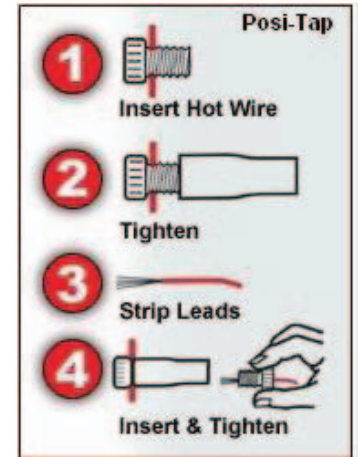

- 6 Remove the airbox cover by removing the 8 bolts for the lid (Fig. E).

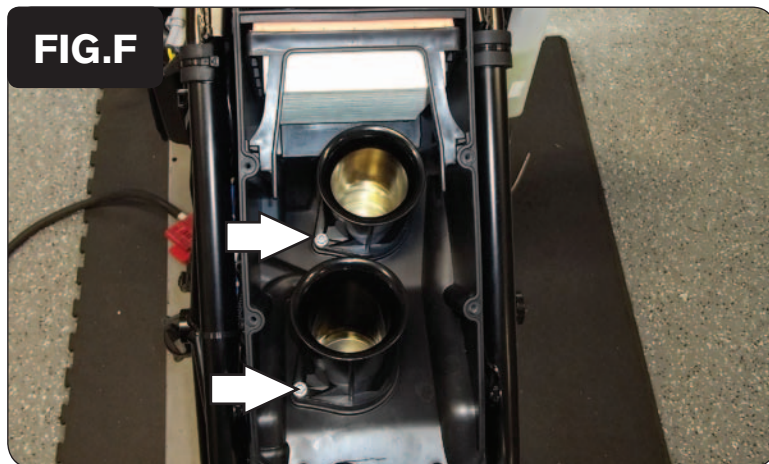

- 7 Remove the airbox by removing the 4 bolts for the velocity stacks (Fig. F).  
*2 of the bolts are not shown in Figure F.*

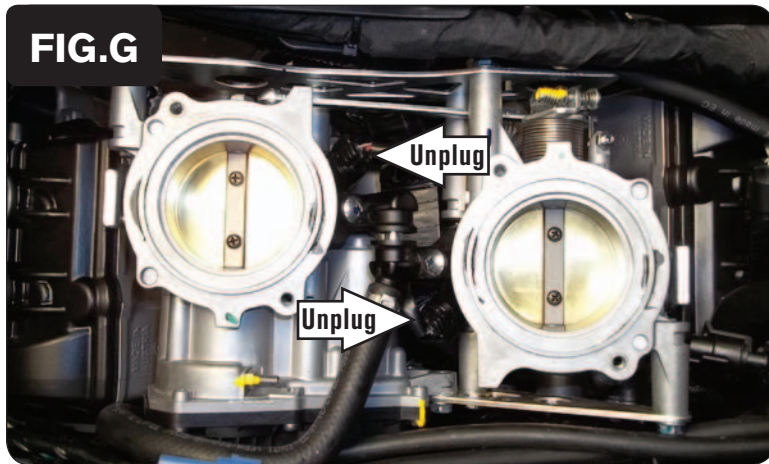

- 8 Unplug the stock wiring harness from both of the fuel injectors (Fig. G).

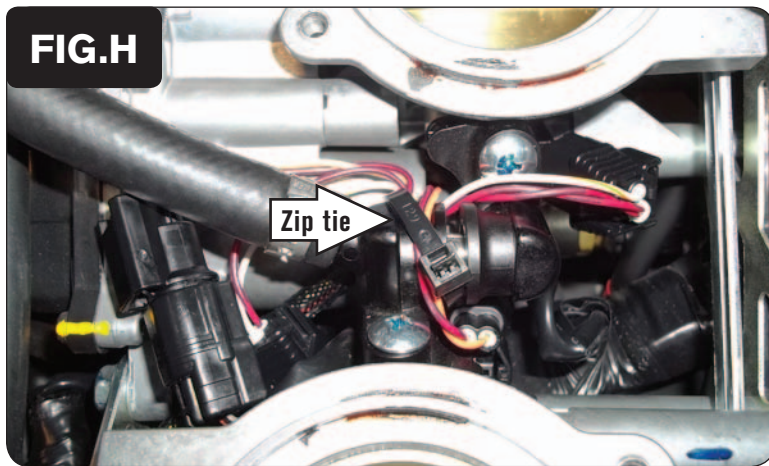

- 9 Plug the PCV harness in-line of the stock wiring harness and both fuel injectors (Fig. H).

*The pair of PCV leads with ORANGE colored wires go to the front cylinder. The pair with YELLOW colored wires go to the rear cylinder.*

- 10 Use the supplied zip tie to secure the PCV wires in place. Make sure they do not interfere with the throttle linkage.



- 11 Unplug the stock wiring harness from the Crank Position Sensor (Fig. J).

*This is a 2-pin BLUE connector pair located to the left of the throttle bodies.*

**FIG.K**



- 12 Plug the PCV connectors with the BROWN/WHITE and WHITE/BROWN wires in-line of the stock Crank Position Sensor connectors (Fig. K).
- 13 Reinstall the airbox, the fuel tank, all of the removed bodywork, and the seats.